

Fire Detection Product Catalogue



Australia - Issue 6

The power behind **your mission**

Johnson
Controls 

Introduction

Welcome to this sixth edition of the Johnson Controls Fire Detection Product Catalogue for Australia.

We aim to make our product range as comprehensive as possible to ensure you never need to go anywhere else. To meet this goal, our product specialists, with your help, have selected the most appropriate, cost effective product range available. Only those products that meet the highest quality criteria have been included.

Our National Distribution Centre, located in Sydney, is one of the largest Fire & Security product distribution centres in Australia. Our goal is to despatch products on the same day we receive your order before 2:00 pm.

Our warranty and service returns policy is located towards the back of this catalogue – look for “Warranty Procedure” on page 129 for your reference.

We recognise that your business is highly dependant on reliable products. All our Johnson Controls manufactured products are backed by a 24 months warranty. A purchase order and Return Authorisation (contact Customer Service) is required for parts to be replaced under warranty.

For all enquiries regarding this catalogue, please contact
Johnson Controls Customer Service

Telephone: 1300 725 688

Facsimile: 1300 720 733

Email: fdp.customerservice.anz@jci.com

For Technical Support, please contact
Johnson Controls Technical Services

Telephone: 1300 552 559

Fire Detection Product Catalogue

5 VIGILANT
Non-Addressable Fire
Indicator Panels



7 VIGILANT
Non-Addressable
Detectors



9 VIGILANT
Non-Addressable
Detector Bases



10 Non-Addressable
Manual Call Points



12 VIGILANT Addressable
Fire Indicator Panels



16 MX Addressable
Detectors



21 MX Functional Detector
Bases



25 MX Addressable
Modules

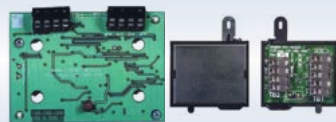

30 VIGILANT Responders



41 Series 130
Addressable Detectors



43 Series 130
Addressable Modules



45 SIMPLEX Fire Indicator
Panels

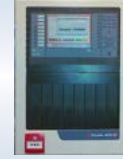

51 SIMPLEX High Level
Interface



54 TrueAlarm
Addressable Detectors



57 MAPNET II/IDNet
Addressable Devices



61 Detector Accessories
and Remote Indicators



63 Fire Panel Ancillaries



65 VIGILANT
19in Rack
Cabinets



69 Looms and Cables

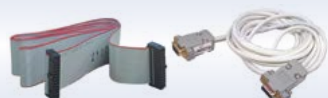

72 AS1668 Control and Gas Control



91 Warning Systems – Audio Devices



74 VIGILANT Remote Annunciators



95 Audio Visual Indicators



75 CCU Networking



96 Batteries and Power Supply Units



77 VIGILANT QE90 EWIS Panel



98 Door Holders and Accessories

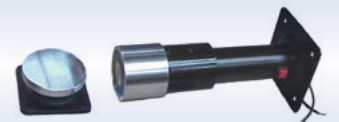

78 EWIS Ancillaries



100 VESDA Aspirating Smoke Detectors



80 EWIS Spares

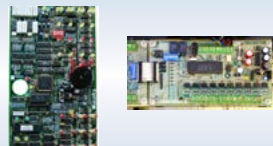

107 Flame & Special Hazard Detection



83 Warning System Generators



113 Beam Smoke & Linear Heat Detection

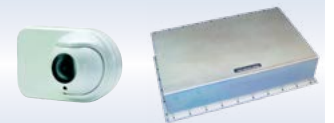

87 Warning Systems – Visual Devices



117 Detector Test Equipment



Table of Contents

5	Conventional (Non-Addressable) Fire Indicator Panels
7	Conventional Detectors - VIGILANT 614 Series
9	Conventional Detector Bases
10	Conventional Manual Call Points
14	Addressable Fire Indicator Panels
16	<i>MX TECHNOLOGY</i> Analogue Addressable Detectors
21	Functional Detector Bases
25	<i>MX TECHNOLOGY</i> Analogue Addressable Modules
30	MX4428 Responders
41	Analogue Addressable 130 Series Detectors
43	Analogue Addressable 130 Series Modules
45	SIMPLEX 4100ESi System Overview
48	Addressable Loop Cards - <i>MX</i> & IDNet
51	SIMPLEX High Level Interface
52	SIMPLEX 4100 Network Systems
54	TrueAlarm Addressable Detectors
56	SIMPLEX Addressable MAPNET II Modules
57	SIMPLEX Addressable MAPNET II/IDNet Modules
58	SIMPLEX Addressable IDNet Modules
61	Detector Accessories & Remote Indicators
63	Fire Panel Ancillaries
65	VIGILANT 19inch Rack Cabinet Range
69	Looms and Cables
72	AS1668 Controls and Gas Controls
74	VIGILANT Remote Annunciators
75	CCU Networking
77	Warning Systems
78	QE90 Ancillaries & Spares
83	Warning System Generators
87	Warning System Ancillaries
95	Audio Visual Indicators (AVI)
96	Batteries and Power Supplies
98	Door Holders & Accessories
100	Aspirating Smoke Detectors VESDA
107	Flame and Special Hazard Detectors
108	Intrinsically Safe - <i>MX</i> Analogue Addressable Detectors
110	Intrinsically Safe - Conventional (Non-Addressable) Detectors
113	Intrinsically Safe Isolators/Barriers
113	Beam Smoke and Linear Heat Detectors
117	Detector Test Equipment
120	International Protection Ratings
121	Symbols
123	Reference Tables
123	Conventional (non-addressable) Detector Selection Chart
124	<i>MX</i> Detector Selection Chart
124	VIGILANT/Minerva Sounder Base Selection Guide
125	Spare Parts List
129	Warranty Procedure
130	QE90 EWIS Panel Configuration
131	Index
134	Product Index
135	Terms and Conditions

Conventional (Non-Addressable) Fire Indicator Panels

F3200 8 Zone



The 8 zone F3200 will suit small installations requiring a system up to 8 detection circuits and provides all the features of the existing F3200 Fire Indicator Panel (FIP) range.

This panel is a replacement for the F08 FIP. It is a compact, self-contained panel which performs the functions of the Control and Indicating Equipment (CIE), as specified by the Australian Standard AS 4428.1 Fire Detection, Control and Intercom Systems - Control and Indicating Equipment.

The 8 zone F3200 offers features including: -

- AS4428 Firefighter Facility
- LCD Display
- Flexible programmable logic equations
- Event logging to history file
- Networking capabilities - up to 250 panels (with MX1 as MFIP)
- Eight zones fitted
- Standard 3A Power Supply to power a T-GEN 50
- Battery capacity 2x17Ah

Operation is straightforward with the F3200's keypad and alphanumeric LCD. The 40 character, 2 line LCD zone control panel meets the AS 4428.1 "Firefighter Facility" (FF) requirements. "Next" and "Prev" keys allow easy scrolling through the 99 event alarm buffer, while all current alarms, faults and isolated zones can be separately displayed.

ActivFire Listed: afp-789

Remote Annunciators, refer to Page 74

Part Numbers

Panel:

FP0784 8 zones fitted (max.) 3A PSU, 8U Cabinet (batteries not included)

Manuals

LT0250 F3200 Operator's Manual

LT0255 F3200 Installation and Configuration Manual

LT0256 F3200 Programming Manual

Physical

Cabinet Dimensions (HWD)

FP0780 15U - 750 x 550 x 211 mm

Weight 25kg

FP0784 8U - 440 x 550 x 211 mm

Weight 17kg

IP Rating IP30

Part Numbers

Blank Panels - (includes 19" rack fixing hardware)

FZ9002 7U Blank Hinged Inner Door (312mm)

FZ9003 6U Blank Panel Acrylic (267mm)

FZ9004 4U Blank Panel (178mm)

FZ9005 3U Blank Panel (134mm)

FZ9006 2U Blank Panel (89mm)

FZ9007 1U Blank Panel (45mm)

FZ9015 5U Blank Panel (223mm)

FZ9016 6U Blank Panel (267mm)

Cabinets - Refer to Page 65

F3200 8 - 64 Zone



The F3200 is a self-contained, modular, microprocessor based FIP which performs the functions of the CIE as specified by AS 4428. It has a high degree of flexibility and expandability, catering for medium to very large buildings.

A single panel has 8 zones fitted as standard, and can have up to 64 zones. A network system may have up to 64 panels. The F3200 can be fitted with 64 zone LEDs and supports AS 1668 fan controls and gas release.

The F3200 detector circuit electronics caters for a wide range of detectors. It also caters for interfacing to Intrinsically safe circuit barriers/isolators (hazardous areas), long line circuits e.g. from a sub-indicator FIP and tamper-proof circuits. Typically the 15U cabinet has space to accommodate up to 40Ah battery capacity. The ActivFire Listings are: afp-789 (VIGILANT), afp-1421 (Simplex).

Part Numbers

Panel

FP0780 8 zones fitted 24 zone capacity, no cardframe 3A PSU, 15U Cabinet

FP0781 8 zones fitted 64 zone capacity, incl. cardframe 3A PSU, 15U Cab't

FP0782 8 zones fitted 24 zone capacity, no cardframe 6A PSU, 15U Cabinet

FP0783 8 zones fitted 64 zone capacity, incl. cardframe 6A PSU, 15U Cab't

Manuals

LT0250 F3200 Operator's Manual

LT0121 F3200 Technical Manual

LT0255 F3200 Installation & Configuration Manual

LT0256 F3200 Programming Manual

LT0130 F3200 Presentation Drawings (AutoCAD)

LT0135 F3200 Architect's Specification A4

Options

FP0553 8 zone input expansion kit (incl. PA0492, LM0053, 8xEOLR)

FP0554 8 relay expansion kit (incl. PA0493, LM0053, 8x MiniJump Links)

FP0795 Network upgrade kit (AS4428) {incl. IC0358, SF0222, LT0330, PA0773, LM0091}

FP0749 3A to 6A PSU Upgrade Kit (AS1603)

FP0779 3A to 6A PSU Upgrade Kit (AS4428)

FP1002 MX1 style Display Extender Kit (incl. FP1002, LM0291, LM0339)

FZ3031 FP0475 Disp. Extender Kit incl 1.2m FRC. Use as first (LHS) Display.

FZ9028 3U WA/Cube ASE Bracket & Loom

FP0475 Display Extender kit (incl PA0454, LM0046 FRC, not for 1st display)

KT0072 Cardframe upgrade kit

KT0199 3U Centaur ASE Bracket

KT0274 F3200 AS1603 to AS4428 U/G Kit (incl. ME0098, LM0092, SF0423)

KT0429 F3200/NDU Upgrade to V5.xx Software

ME0457 MX1 style 4U Display Door, 5x16 Zone, requires FP1002

LED Displays - Refer to Page 64

Spares - Refer to Page 125

F3200 Single Zone Gas Control Panel



FP0876 8U Panel with 3A PSU

The F3200 Single Zone (single risk) Gas Control Panel is designed to meet the CIE requirements of AS 4214-2002, "Gaseous Fire Extinguishing Systems".

It includes all circuits and relays normally required for single zone gas control panels. When coupled with the AVI Mk2 warning signs and FP0570/2 Local Gas Control Stations it provides a cost-effective, easily programmed single zone gaseous fire extinguishing system.

FP0876 is an F3200 in an 8U cabinet (FP0784) complete with an ME0442 1 zone, 1U gas control module pre-wired to the 8 zone module and an 8 relay module.

Specifications

Dimensions

FP0876 8U - 440 x 550 x 211mm (HWD)
 FP0877 15U - 750 x 550 x 211mm (HWD)

Part Numbers

FP0876 F3200 AS4428 8U, 3A PSU, 1U Gas Ctrl, Pre Prog. (shown at left)
 FP0877 F3200 AS4428 15U, 6A PSU 1U Gas Ctrl Pre Prog.

FP0877 is based on a 6 Amp power supply F3200 assembled into the standard 15U cabinet (FP0782). It comes complete with an ME0442 1 zone, 1U gas control module pre-wired to the 8 zone module and an 8 relay module.

Gas Control Stations - refer to page 72
 Warning Signs - refer to page 95

F3200 Expansion Kits



FP0553, F3200 8 Zone Input Expansion Kit
 Includes: PA0492, 8 Zone Module, LM0053 FRC, 8 x EOLR (std). (EOL = 2k7 5% 0.4W).
 Size: 195 x 125 x 12mm, 220g

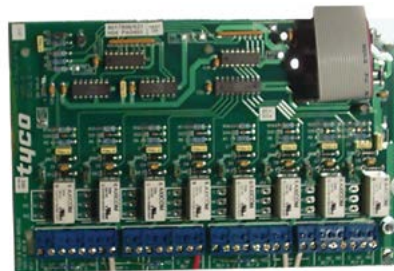

FP0554, F3200 8 Relay Expansion Kit
 Includes: PA0493 8 Relay Module, LM0053 FRC, 8 x Minijump links (for supervision selection).
 Size: 195 x 125 x 12mm 250g

Part Numbers

KT0072 F3200 Cardframe Upgrade Kit (see below)
 FP0553 F3200 8 Zone Input Expansion Kit
 FP0554 F3200 8 Relay Expansion Kit
 FP0749 F3200 AS1603.4 PSU Upgrade Kit 3A to 6A
 FP0779 F3200 AS 4428.1 PSU Upgrade Kit 3A to 6A
 PA0873 F3200 AS4428 MAF/PSU 3A 1931-3-3
 PA0874 F3200 AS4428 MAF/PSU 6A 1931-3-3

KT0072 F3200 Cardframe Upgrade Kit



A KT0072 Cardframe upgrade kit can be fitted to a 15U F3200 to allow it to take more than three 8 way modules. The KT0072 cardframe can accommodate 8 F3200 modules (for MX4428:- 8 ADR or 6 MPR/MXP/ADR+RRM). In older versions, the cardframe mounts directly to the rear of the cabinet. In newer versions, the cardframe is fitted to a gear plate that may be removed when the cabinet is mounted to the wall.

Part Numbers

KT0072 F3200 Cardframe Upgrade Kit

F3200 Spares



PA0873, F3200 AS4428 MAF/PSU 3A 1931-3-3
 Size: 160 x 250 x 45 mm, 400g



PA0874, F3200 AS4428 MAF/PSU 6A 1931-3-3
 Size: 160 x 250 x 45 mm, 400g

For a comprehensive list of spares, refer to page 125

Conventional Detectors – VIGILANT 614 Series

The VIGILANT 614 range of low profile non-addressable detectors have a number of unique design features that offer improved operation, installation and ease of servicing. Through innovative design, these detectors have reduced the installation and servicing time to a minimum. The VIGILANT 614 range includes the 614CH Carbon Monoxide fire detector, which responds to carbonaceous fires with an unprecedented early detection of slow smouldering fires, yet offers unequalled false alarm immunity.

The use of the patented optical sensing chamber, together with refined signal processing, has enabled the introduction of a smoke detector suitable for fast, reliable smoke detection of both slow and fast developing fires.

The VIGILANT 614 series is compatible with conventional (non-addressable) circuits on VIGILANT F3200, and addressable panels using suitable interface modules on MX1, MX4428, 4100ESi.

Features

- Range includes unique CO+Heat fire detector
- Type A, B, C and D Heat detector
- Low profile and discreet
- Superior performance and reliability
- Patented optical chamber
- Attractive design
- Designed for fast, easy installation
- Detector Lock included with 4B base
- Integral and remote alarm LED
- ActivFire and FPANZ Listing

614CH Carbon Monoxide and Heat Fire Detector



The 614CH fire detector provides very early warning of slow smouldering fires. The CO fire detector is well suited to many applications where heat detection is insufficient but smoke detection causes unwanted alarms. As CO travels more freely than smoke, the positioning of CO fire detectors is more flexible. This feature is particularly useful in large complex structures such as atria and warehouses, where positioning of smoke detectors is difficult. The 614CH has an additional mode of operation as a Class A1R combined rate-of-rise and 60°C fixed temperature heat detector to supplement the CO detector mode to permit the detector to react to a wider range of fire types. Although the 614CH has a rated service life of 10 years, in order for the 614CH to provide the intended level of fire detection, the detector should be checked for calibration 5 years after installation (or 5 years after re-installation following service) or within 7 years of the date of manufacture.

Specifications

Operating Voltage	10 to 33Vdc
Quiescent Current	55µA (max.)
Alarm Current ¹	3.2 to 67mA (50°C)
Alarm State Voltage	2.5 to 7.4Vdc
Alarm Threshold	38ppm CO
Ext. Powered Load (max.)	50mA, 28Vdc
Remote Indicator	E500 Mk2 Series
Relative Humidity	15 to 90% (n/cond)
Ambient Temp	0 to +50°C
Dimensions (incl. base)	127 dia x 54H (mm)
Weight	200g with base
ActivFire Listed	afp-1718
FPANZ Listed	VF/345
Part Number	516.600.304

¹ 3.2mA min. for LED visibility. Max. current must be externally limited

614P Photoelectric Smoke Detector



The 614P is capable of detecting the visible smoke produced by materials which smoulder or burn slowly, i.e. soft furnishings, plastic foam etc. or 'smoke' produced by overheated but unburnt PVC. These detectors are particularly suitable for general applications and areas where cable overheating may occur; electrical services areas. The novel design of the asymmetrical sampling chamber and signal processing techniques stop unwanted alarms caused by very small insects. Smoke entering the sampling chamber scatters the infrared light pulses onto a photodiode. These pulses are converted to an electrical signal that is compared against a preset alarm level.

Specifications

Operating Voltage	10 to 33Vdc
Quiescent Current	60µA
Alarm Current (max.)*	0.7 to 67mA (55°C) 0.7 to 60mA (70°C)
Alarm State Voltage	2.5 to 7.4V
Ext. Powered Load (max.)	50mA, 28Vdc
Sensitivity (AS7240.7-2004)	4%Obs/m
Remote Indicator	E500 Mk2 Series
Relative Humidity	10% to 95% (n/cond)
Ambient Temperature	-20°C to +70°C
Dimensions (incl. base)	127 dia x 54H (mm)
Weight	188g with base
ActivFire Listed	afp-1715
FPANZ Listed	VF/344
Part Number	516.600.301

*Max. current must be externally limited

614I Ion Chamber Smoke Detector



The 614I detectors are offered for legacy specifications which still call for ionisation smoke detectors. The 614I offers detection of visible and invisible fire aerosols (products of combustion) and is therefore capable of detecting the early presence of hot smouldering and flaming fires, such as wood, paper etc. They use a dual ionisation chamber in which the air is ionised by a single radioactive source. The presence of smoke in the sampling chamber causes a change in the balance voltage between the two chambers. This is then compared against an alarm level.

Use of ionisation chamber smoke detectors is not recommended for new installations.

Specifications

Operating Voltage	12 to 33Vdc
Quiescent Current	70µA
Alarm Current*	0.7 to 67mA (55°C) 0.7 to 60mA (70°C)
Alarm State Voltage	2.5 to 7.4V
Ext. Powered Load (max.)	50mA, 28Vdc
Ionisation Source	<33kBq (Am241)
Alarm Threshold	0.32 MIC X
Remote Indicator	E500 Mk2 Series
Relative Humidity	10% to 95% (n/cond)
Ambient Temperature	-20°C to +70°C
Dimensions (incl. base)	127 dia x 54H (mm)
Weight	200g with base
ActivFire Listed	afp-1716
FPANZ Listed	VF/343
Part Number	516.600.305

*3.2mA min. for LED visibility. Max. current must be externally limited

Conventional Detectors – VIGILANT 614 Series

614T Heat Detector



VIGILANT 614T heat detectors use a fast response, thermistor based design. The fixed temperature sensing thermistor readily tracks the local ambient temperature, thus quickly, accurately and consistently identifying when a fixed temperature is exceeded. Rate-of-rise detection is achieved by comparing the response of two thermistors, with one having a slower thermal response. By combining accurate thermistors with proper physical placement, this patented rate-of-rise detection design achieves a high level of heat detection performance.

Part Number	Model	Type	ActivFire Listed
4098-9637EA	614TA	Type A	afp-1813
4098-9638EA	614TB	Type B	afp-1814
4098-9639EA	614TC	Type C	afp-1815
4098-9640EA	614TD	Type D	afp-1816

Specifications

Operating Voltage	11 to 32Vdc
Quiescent Current ¹	85µA @ 24Vdc (typ.)
Alarm Current ²	5mA to 80mA
Alarm State Voltage ³	3.0V to 12.4V
Remote Indicator	E500 Mk2 Series
Relative Humidity	10% to 95% (n/cond)
Ambient Temperature	
Types A, B	-10°C to +45°C
Types C, D	-10°C to +75°C
Storage Temperature	-20°C to +75°C
Dimensions (mm)	127 dia x 53H
Weight	174g with 5B base

1. Max. quiescent 110µA. 2. Min. 5mA for LED visibility; max. current must be externally limited. 3. Min. voltage with remote indicator shorted @ 5mA. Max @ 80mA without remote indicator connected.

885WP-B IP67 Heat Detector



The 885WP-B is a 2 wire fixed temperature Type B heat detector. This detector is designed to provide open area protection in areas subject to moisture. It is sealed against the entry of moisture to a rating of IP67. The LED will latch on when the detector is in alarm. Detectors are used with a mounting base that permits mounting directly on to a 50mm or 60mm junction box. The 885WP-B includes a tamper-resistant feature that prevents its removal from the mounting base without the use of a key. Flying leads are provided for termination:- 2 Black (negative), 2 Red (positive), 2 White (positive Remote LED).

Specifications

Operating Voltage	8.5 to 30Vdc
Quiescent Current	< 50µA
Alarm Current (min.)	2mA @ 3.1Vdc
Alarm Current (max.)	80mA @ 6.5Vdc
Max. Air Velocity	20m/s
Alarm Temperature	63°C (fixed temp.)
Ambient Temperature	-15°C to +50°C
Dimensions (mm)	102 dia x 48H
Weight	170g with base
Ingress Protection	IP67
ActivFire Listing	afp-1778
Part Number	885WP-B

D515B Duct Sampling Unit

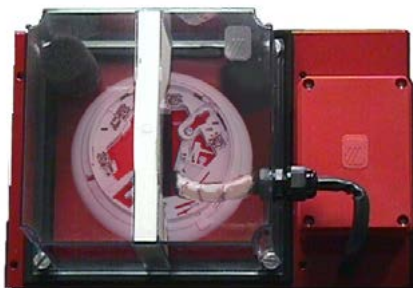

The D515B Duct Sampling Unit consists of a D51B duct housing fitted with a 4B base suitable for fitting a non-addressable 614P photoelectric smoke detector. The D51B is designed to sample air in air conditioning ducts and pass the air through the smoke detector. The housing is fixed on the outside of the duct to be sampled, allowing easy access for detector servicing and replacement of the dust filter. To cater for most duct sizes, a sampling tube extension is available in 3 metre lengths. VIGILANT E500 Mk2 Series Remote Indicators can be used for remote indication of an alarm. The D515B with 614P can be used with F3200 CIE logic for non-latching operation. The D515B with VIGILANT 614P is compatible with non-addressable alarm zone circuits on VIGILANT and SIMPLEX CIE.

Specifications

Duct Pressure*	-1.15 to +3.0 kPa
Sampling Tube Length	160mm minimum
Max. Duct Width	1.8m
Remote Indicator	E500 Mk2 Series
Dimensions	
Base & Cover (LWH)	278x190x113 mm
Fixed Tube Length	160 mm below base
Sampling Tube Pitch	122mm
Duct Holes Required	24mm dia. x 2 places

Not ActivFire Listed

Part Numbers

D515B	D51 c/w 4B base**
D51COVER	D51 Cover only c/w screws
D51L	Baffle box of 10
D51F	Filter box of 10
D51T3	3m Sampling Tube
D51K100	Sampling Tube End Cap pkt of 10

*AS 1603.13-1998 test

**Wired for collective base

Conventional Detector Bases

4B Universal Base



The 4B Universal Base contains no electronics and is suitable for indoor applications of the 614 series conventional (non-addressable), 814 and 850 series analogue addressable detectors. It provides excellent space for cable access and terminations. It features remote LED connections and an anti-tamper facility. The 4B base is designed to snap-fit into the ceiling tile adaptor, or screw fix to the ceiling in the traditional manner.

The Euro Mount Adaptor is a shallow (20mm deep) back box for surface mounting applications.

The 4B-6A Adaptor covers ceiling marks revealed when changing from an existing 5" or 6" base.

Specifications

Operating Temp.	-25°C to +75°C
Relative Humidity	10% to 95% (non cond.)
Dimensions (mm)	109 dia x 25H
Weight	64g
ActivFire Listed with compatible detectors	

Part Numbers

517.050.041	4B Base
517.050.052	Euro Mount Adaptor
517.050.056	4B-6A 4" to 6" Adaptor

Ceiling Tile Adaptor



The Ceiling Tile Adaptor (CTA) is used to prepare a ceiling tile to be able to accept a complete base and detector assembly. It comprises a Bezel (1), Clamp (2) and Back Box (3). Traditionally the detector base is installed without the detector head, as mounting screws must be inserted through the back plate of the base. The CTA can save time by allowing a system to be installed and commissioned before the ceiling is installed. Once the ceiling is installed the base and detector assembly can be pulled into place without the need for disassembly and re-testing.

Specifications

Dimensions (H x Dia)	52 x 165 mm
Weight	232g
Ceiling Cutout	127mm (30mm max. tile)
Material	Flame Retardant ABS
Colour	White
Ambient Temperature	-25°C to +70°C
Storage Temperature	-40°C to +80°C
Relative Humidity	10% to 95% (non cond.)

Part Numbers

517.050.060	Ceiling Tile Adaptor Kit
- 517.050.056	Back Box
- 517.050.057	Bezel and Clamp
517.050.058	CTA-AP Ceiling Tile Sounder Base Adaptor Plate (8x111 dia. not shown)

4B-DHM Deckhead Mounting



The Deckhead Mounting can be used with VIGILANT 600/800 Series detectors using 4B base when fitted in particularly damp or dirty environments. Only suitable detectors should be used - consult bulletin GPBD0018. The housing has four 20/25mm cable breakouts and is secured with two countersunk screws at 128.5mm fixing centres. The mounting surface should be flat over the area of the underside of the housing to ensure a stable fixing and strong enough to take the weight of the mounting, detector base and sensor. Extra Base Accessory Terminals (BATs) are available (one is supplied).

Specifications

Ambient Temperature	-25°C to +70°C
Relative Humidity	up to 95% (non cond.)
Dimensions (mm)	115 dia x 42H (147.5 W overall)
Weight	200g
Protection	IP55 c/w supplied gasket

Part Numbers

517.050.051	4B-DHM
517.050.612	BAT Kit - pack of 10 (available on request)

601SB Sounder Base



The 601SB Sounder Base provides a sounder function on conventional fire detection circuits. It operates independently of the detector circuit and may be used without an associated detector. When used without a detector, a sounder base cap should be fitted to cover the exposed terminals. The 601SB requires an external 24V dc supply and provides eight tones including the ISO8201 T3 evacuation signal. It is identified by a green temporary park plunger. Refer to Sounder Base Applications table for further details.

Specifications

Operating Voltage	18 to 32Vdc
Alarm State Current	1.2mA @ 68dBA (low vol) 6.8mA @ 90dBA (max vol)
Ambient Temperature	-25°C to +70°C
Relative Humidity	10% to 95% (non cond.)
Dimensions (mm)	108 dia x 38H
Weight	195g
Wire Size	1.5mm ² to 2.5mm ²
Not ActivFire Listed	

Part Numbers

577.001.035	601SB
577.001.040	Sounder Base Cap

Volume Adjustment Tool



A simple Volume Adjustment Tool, specific to the task of sounder volume selection on the "variable-volume" range of VIGILANT MKII Sounder Base Devices. Sounder volume can be easily varied using this simple, functional tool.

Part Number

517.050.015	Volume Adjustment Tool
-------------	------------------------

Conventional Manual Call Points

SU0631 Manual Call Point



The SU0631 Manual Call Point is supplied with one normally open and one normally closed contact. Selecting either the "Normally Open" or "Normally Closed" contact is easily achieved by simply connecting the terminal block to the required connection in the back of the MCP. Single pole changeover switching can be achieved with the use of two terminal blocks. The call point is operated when the frangible glass element is snapped, releasing the MCP's micro switch, which signals an alarm to the fire panel. The Call Point and Backbox are ordered separately. Unless stated the VIGILANT indoor manual call points are supplied as flush mount units. The VIGILANT range are approved for use with the standard backbox if surface mounting is required.

Specifications

Max. Operating Voltage	30Vdc
Max. Switch Current	2A
Cable Termination	0.5 to 2.5 mm ²
Relative Humidity	0 to 95% (non/cond)
Ambient Temperature	-10°C to +55°C
Dimensions (HWD)	93x89x60mm
Weight	110g (flush)
Ingress Protection	IP24D
ActivFire Listed	afp-3239

Part Numbers

SU0631	Manual Call Point
SU0632	Red Backbox
SC070	Spare Test Keys (pkt10)
515.001.025	Spare Glass (pkt 5)

SU0634 IP67 Waterproof Call Point



This surface mounting Manual Call Point has an Ingress Protection rating of IP67, making it suitable for wet area applications. The callpoint is operated by simply pressing on the centre of the frangible element until it snaps, which releases a microswitch, signaling an alarm at the CIE. A plastic coated frangible element ensures safe and reliable operation, and does not produce dangerous glass shards. The SU0634 is supplied with one normally - open and one normally - closed contact. Selecting either configuration is achieved by locating the terminal block on the appropriate connection. Single pole change-over switching can be achieved using two terminal blocks.

Specifications

Operating Voltage	30Vdc (max.)
Switch Current	2A @ 30Vdc (max.)
Cable Termination	0.5mm ² to 2.5mm ²
Dimensions (HWD)	93x98x76 mm
Weight	270g
Ambient Temperature	-30°C to +70°C
Relative Humidity	up to 95% (non-cond.)
Ingress Protection	IP67
Not ActivFire listed by Johnson Controls	

Part Numbers

SU0634	IP67 Manual Call Point
515.001.025	Spare Glass (pk 5)
SC070	Spare Test Keys (pkt10)

Manual Call Point Accessories



Specifications

Dims (mm)	75W x 40H typical
Part Numbers	
SU0603	Spare glass VIGILANT (Pkt 10) white text on black background
SU0605	Spare glass WORMALD (Pkt 10) white text on black background
SU0609	Spare glass Black pictogram on white background (Pkt 10)
515.001.025	Spare glass no logo (Pkt 5) clear text on white background
515.001.127	Flexible plastic element



Specifications

Ambient Temperature	-10°C to +55°C
Dimensions (HWD)	86 sq x 32 mm
Part Numbers	
SU0632	Red Backbox



Part Number

SR3T-P Red surface mounting back box (for indoor callpoints) with terminals fitted.



Part Number

SC070 Packet of ten Test keys for VIGILANT MCPs



Part Number

515.001.043 This polycarbonate breakglass keybox is available to protect emergency keys



Part Number

SU0615 Transparent hinged cover to suit all SUxxx call points (MCP not included) Material LEXAN241 polycarbonate.

Weather STOPPER



STI6535 Weather STOPPER

The callpoint STOPPER provides protection from malicious or accidental activation of manual callpoints. Available for flush or surface mounted callpoints the 'STOPPER' is also available with optional high pitch sounder which is activated when the lid is lifted. An optional 'Break-Seal' fitting kit allows 'Break-Seals' to be used to provide extra protection.



IP036 Break Seal Kit

Specifications

	STI6535	STI3150
Dims (HWD)	210x137x57.5	254x178x86
Call Point Size	100x100x57.5	160x160x120
Ingress Protect'n	Equivalent to IP44 when mounted on a smooth surface	

Part Numbers

515.001.035	STI3120 Weather Stopper II
515.001.036	STI6535 Weather Stopper
515.001.033	IP036 Break Seal Kit
STI-13120FR	STI3120 Surface fit Weather STOPPER with sounder

Weather STOPPER II



STI3150 Weather STOPPER II

The Weather STOPPER II extends the life of weather exposed callpoints, by offering protection against harsh conditions and environments, e.g, oil rigs and ship decks. While offering environmental protection the Weather STOPPER II is constructed from polycarbonate which will also guard against tampering or accidental operation of devices.

Weather STOPPER

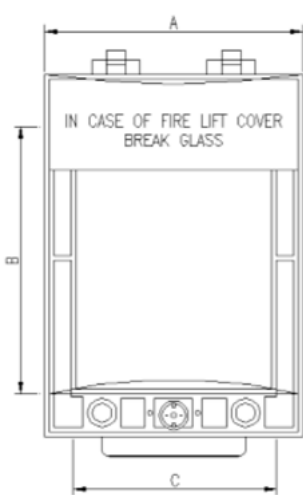

Weather STOPPER II

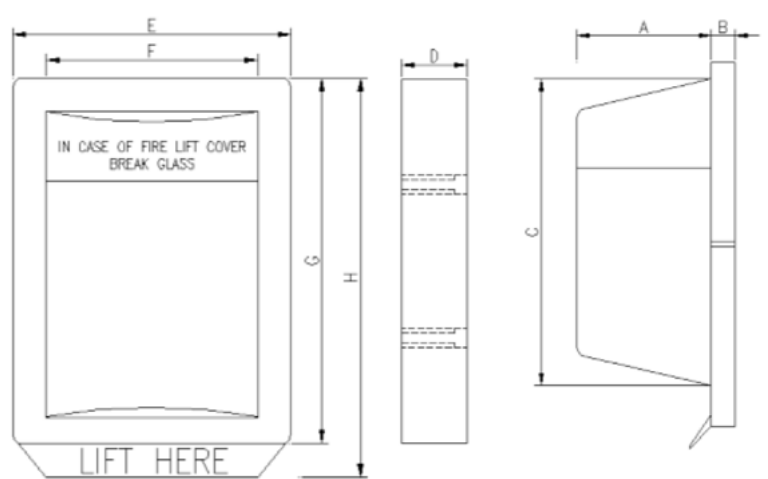

STOPPER	
A	137 mm
B	140 mm
C	104 mm
D	45 mm
E	12.5 mm
F	12.5 mm
G	185 mm
H	12.5 mm
Max. MCP	100 sq. x 57.5 mm (+30 mm Surface)

STOPPER II	
A	70 mm
B	16 mm
C	197 mm
D	50 mm
E	178 mm
F	146 mm
G	228 mm
H	254 mm
Max. MCP	160 sq. x 120 mm

WEATHER STOPPER MODEL COMPARISON						
Product Code	Ref	STOPPER		STOPPER II	With Sounder	Weatherproof
		Flush	Surface			
515.001.029	STI6530	✓				
515.001.030	STI6531		✓			
515.001.036	STI6535		✓			✓
515.001.034	STI1230			✓		
515.001.035	STI3150			✓		✓
515.001.031	STI6532	✓			✓	
STI-13120FR	STI-13120FR		✓		✓	

Addressable Fire Indicator Panels

MX1 Fire Alarm System



MX1 15U

Note: Optional 3U ASE bracket, 3U T-Gen 60 Grade 3 User Interface, and 3U AS1668 Fan Control bracket shown fitted

- Single MX DIGITAL Loop supporting up to 250 MX devices
- Add up to 7 optional MX DIGITAL loop cards for a total of 2000 MX devices
- Network up to 250 MX1* panels over fibre, copper or ethernet
- MX DIGITAL multi-sensor analogue addressable detector technology
- Field-proven fire detection algorithms
- Bi-directional IR communication with 850 Series Gen6 detectors
- Clear alarm messages on 4-line LCD
- Compact zone LED display
- High level EWIS interface
- Up to 126 AS 1668 Fan Controls
- "Profiles" simplify programming of complex detection and logic functions
- Day/Night modes for alarm sensitivity adjustment and output logic functions
- Powerful, field-programmable logic equations, functions, timers
- Pseudo points controlled by logic equations for enhanced control options
- Built-in clock/ calendar with automatic daylight saving adjustment
- Comprehensive test facilities including automatic self-test and fast commissioning test mode
- High capacity integral 5A power supply
- 19" Rack Cabinet
- Earth fault supervision
- Fuse supervision
- Windows-based programming tools

*With MX1 as the main FIP, a network of up to 250 panels (MX1 / MX4428 / F3200) can be connected on the same system.

The VIGILANT MX1 is an innovative, networkable multiple loop analogue addressable fire indicator panel incorporating the latest technology. It complies with AS 7240.2:2004, AS 7240.4:2004, AS 4428.3:2010 and the functional requirements of AS 4428.10:1998 and AS 4428.7:1999. Its support for MX TECHNOLOGY fuzzy-logic detection algorithms and powerful control functions make it suitable for a wide range of fire protection applications, including those in hazardous areas.



MX1 8U

MX1 utilises MX VIRTUAL multi-sensor analogue addressable detectors with dual sensors (photoelectric and heat, or CO and heat) to allow the best detection mode for a situation to be easily selected.

Detection modes may include: smoke/ CO detection only, heat-enhanced smoke/ CO detection only, smoke/ CO plus heat detection, heat-enhanced smoke/ CO plus heat detection or heat detection only.

Heat detection can be either fixed temperature, or combined fixed temperature and rate-of-rise.

For specific applications, single-sensor MX analogue addressable ionisation and photoelectric smoke detectors, high sensitivity smoke detectors (VESDA), heat-only detectors and flame detectors are also available.

The MX DIGITAL communications protocol used on the detection loop is designed to provide high reliability and fault resistance, with operation possible over many cable types.

This often permits system upgrades using existing cable. The loop configuration ensures that communications continues in the event of a loop open circuit fault condition.

In the case of a short circuit, up to 100 short circuit isolator detector bases or modules may be fitted around the loop, to limit the effect of the fault to the devices between isolators.

MX1 is now available as a custom-built Gas Control panel. Contact your local Johnson Controls Fire Detection representative for information.

Approvals

MX1 is certified to AS 7240.2:2004, AS 7240.4:2004: "Fire detection and alarm systems", AS 4428.3:2010: "Fire detection, warning, control and intercom systems - Control and indicating equipment - Fire brigade panel" AS 4428.10:1998: "Fire detection, warning, Control and intercom systems - Alarm investigation" ActivFire Listing Number afp-2320



MX1 Remote Fire Brigade Panel
(surface mount)

Specifications

	15U Cabinet	8U Cabinet
Material	Mild Steel	
Finish	Powdercoated	Titania Ripple
Dims (HWD)	750x550x211	440x550x211 mm
Weight	25kg	17kg
IP Rating	IP30	IP30

Remote Fire Brigade Panel (FP0991)

Material	Mild Steel
Finish	Powdercoated cream wrinkle finish
Dims (HWD)	220x380x56 mm Surface mnt 220x380x21 mm Flush mnt
Weight	3.8kg
IP Rating	IP30

Part Numbers

FP0927	MX1 15U 3U ASE bracket
FP0928	MX1 15U 3U WA/Cube ASE bkt
FP0948	MX1 15U 3U Blank
FP1040	MX1 8U 3U Blank
FP1030	MX1 15U Empty Cab c/w Window
FP0950	MX1 Loop Card Kit
FP1002	LED Disp Ext kit (incl. LM0291,LM0339)
FP0991	MX1 Remote Fire Brigade Panel
FP0996	MX1 4U 19in Rack Mounting Remote Fire Brigade Panel
FP1031	MX1 15U, Empty Cabinet, Blank Door, Titania
FP1121	T-Gen2 3U Grade 3 User Interface incl. T-Gen 60 Amp and mic.
FP1056	MX1 3U 12-way AS 1668 Fan Control Module
FP1057	MX1 2-way AS 1668 Cntrl Bd Exp Programming Cable
LM0076	DB9F-DB9F Null Modem
ME0457	4U Door 5xFP1002 LED Disp Brd
FA2515	Door Lock Catch/Switch Bracket

LED Displays - Refer to Page 64
Spares - Refer to Page 125

Fire Detection Product Catalogue

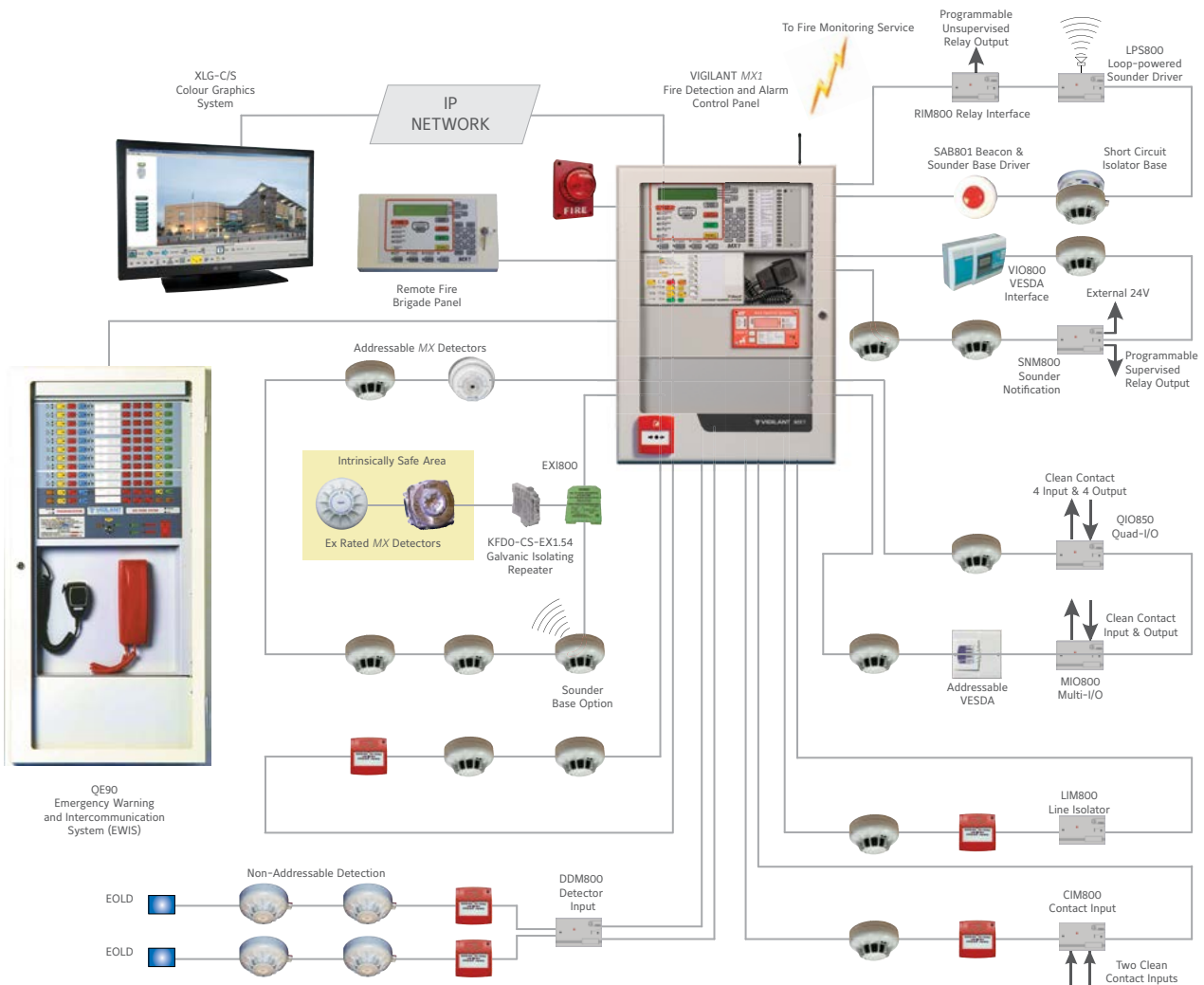

MX1 System Diagram

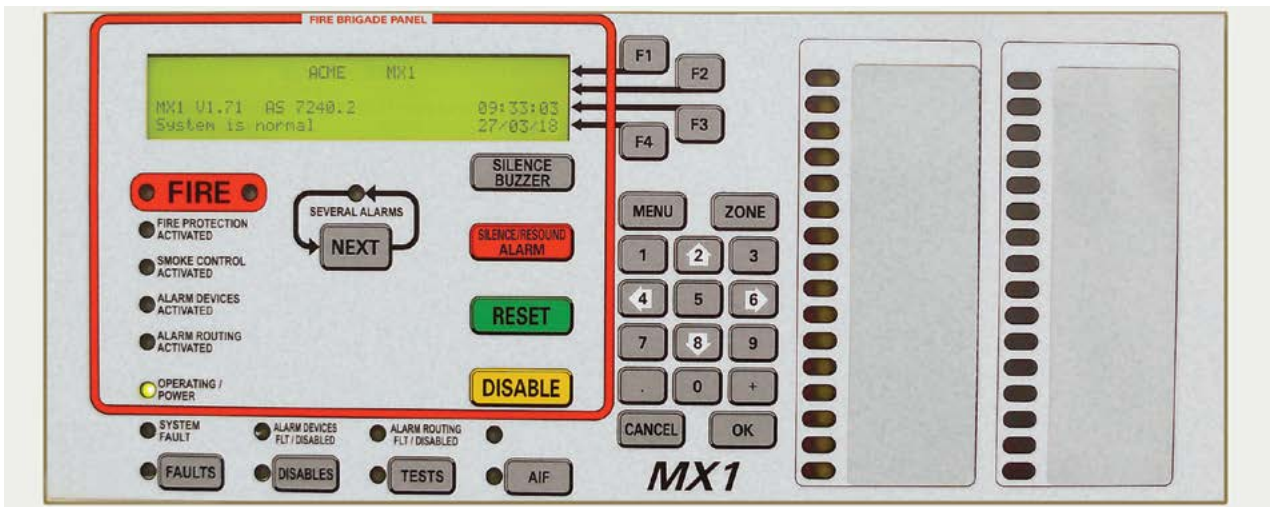

MX1 Control Panel Layout

Addressable Fire Indicator Panels

MX4428 Fire Alarm System



The VIGILANT MX4428 is an intelligent distributed multi-processor fire alarm and fire protection control system, which combines both analogue addressable and conventional (non-addressable) detection. It features intelligent fire detection algorithms, powerful control programmability and multi-panel networking to handle the most complex applications. MX4428 supports the *MX* multi-sensor virtual detectors (Photoelectric and Heat, CO and Heat, Ionisation only, Heat-only) and a range of functional bases, analogue addressable callpoints, input modules, and output modules. Smoke/CO and temperature readings from the multi-sensor detectors are able to be combined in various ways to achieve optimum detection for each location.

Dimensions

Cabinet Dimensions (HWD)

MX4428

FP0821	15U - 750 x 550 x 211 mm - 21kg
FP0487	680 x 470 x 167 mm

The MX4428 is suitable for sprinkler flow switch monitoring and remote testing, AS 1668 air-handling smoke detection and control.

- Comprehensive test facilities
- Automatic self tests
- Field-programmable
- LCD control panel
- Optional Zone LEDs
- LCD zone description text and/or individual point text

Powerful boolean logic functions for output control and network communications allows control and indication of other panels and devices.

Printer logging includes zone text and point events.

Outputs for:

- Door holders
- Local mimics
- Remote repeater panels
- Colour graphics displays
- High level interface for EWIS, BMS, etc.

ActivFire Listed afp-1446

FPANZ Listed VF/117

Part Numbers

Panel

FP0821	MX4428 master, LCD, 5A,15U, no LEDs, no responders
FP0487	Loop Booster Unit 1901-36

Options

FP0475	Disp. Ext. Kit incl 0.5m FRC (not 1st disp.)
FP0545	Printer option kit 1901-112 (comprises PA0749, LM0102, LT0176)
FP0546	Printer DPU414 (also require FP0545)
FP1002	MX1 style Disp.Ext.Kit (FP1002/LM0291/LM0339)
SU0175	Single Paper Roll for FP0546
FP0586	Protocol Translation Module 1942-1
FP0771	I-HUB networking kit
FP0827	Standard Network Kit (incl. hardware, LT0143, PA0773, LM0172)
FZ3031	FP0475 Kit incl 1.2m FRC (for 1st display)
ME0258	1U Document Tray (135 deep)
ME0259	1U Document Tray (310 deep)
ME0457	4U Door for 5 FP1002 Display Boards
KT0199	3U Centaur ASE Bracket
FZ9028	3U WA/Cube ASE Bracket & Loom
KT0419	3U Self-Adhesive A4 Document Holder
LM0041	Programming Cable DB9 to CIE

LED Displays - Refer to Page 64

Spares - refer to page 125

Responders

FP0507-5	EOL002B Pulsing EOL (pkt 5)
FP0529	Empty ADR/MPR box
FP0575	Multi Prot. Resp (MPR)1901-141
FP0755	ADR 4mA det. current 1901-116
PA0453	RRM PCB assy 1901-15
PA0473	IOR PCB 32 in/32 out 1901-72
PA0713	MPR PCB assy 1901-141
PA0815	ADR-M 4mA 15V MCP 1901-116
FP0824	MXP Responder in box
PA0893	MXP PCB only 1901-213
Blank Panels (include 19" rack mounting hardware)	
FZ9007	1U Blank Panel (45mm)
FZ9006	2U Blank Panel (89mm)
FZ9005	3U Blank Panel (134mm)
FZ9004	4U Blank Panel (178mm)
FZ9015	5U Blank Panel (223mm)
FA2017	5.5U Blank Panel Acrylic (244mm)
FZ9003	6U Blank Panel Acrylic (267mm)
FZ9016	6U Blank Panel (267mm)
FZ9002	7U Blank Hinged Inner Door (312mm)

Cabinets - Refer to Page 65

MX4428SL Single Loop Addressable Panel with T-Gen60 Fitted



Note: Optional T-Gen60 Grade 3 UI bracket and ASE shown

The VIGILANT MX4428 Single Loop panel is a competitively-priced fire detection and alarm system that targets small to medium sized applications. It combines the latest *MX DIGITAL* analogue addressable technology, pioneered by Johnson Controls, with intelligent fire detection algorithms, powerful control programmability. As standard, the MX4428 Single Loop panel comes with an *MX* Protocol Responder fitted that supports up to 200 *MX* multi-sensor virtual detectors (Photoelectric and Heat, CO and Heat, Ionisation-only, Heat-only) and a range of functional bases, addressable callpoints, input modules and output modules. It also includes a prewired brigade interface complete with mounting bracket for Centaur ASE (FP0871) / WA/Cube ASE (FP0872). An optional 60W T-gen2 Grade 3 EWS amplifier can be added.

ActivFire Listed afp-1446

Part Numbers

Panel

FP0871	MX4428, single loop pnl c/w ASE brkt
FP0872	MX4428, single loop panel c/w WA/Cube ASE bracket

Options

FP0827	Standard Network Kit (incl. hardware, LT0143, PA0773, LM0172)
FP0771	I-HUB networking kit
FP1121	3U EWS Door c/w T-Gen 60
SF0273	Factory default database

Dimensions

Cabinet Dimensions (HWD)

FP0871	15U - 750 x 550 x 211 mm - 21kg
FP0872	15U - 750 x 550 x 211 mm - 21kg

Fire Detection Product Catalogue

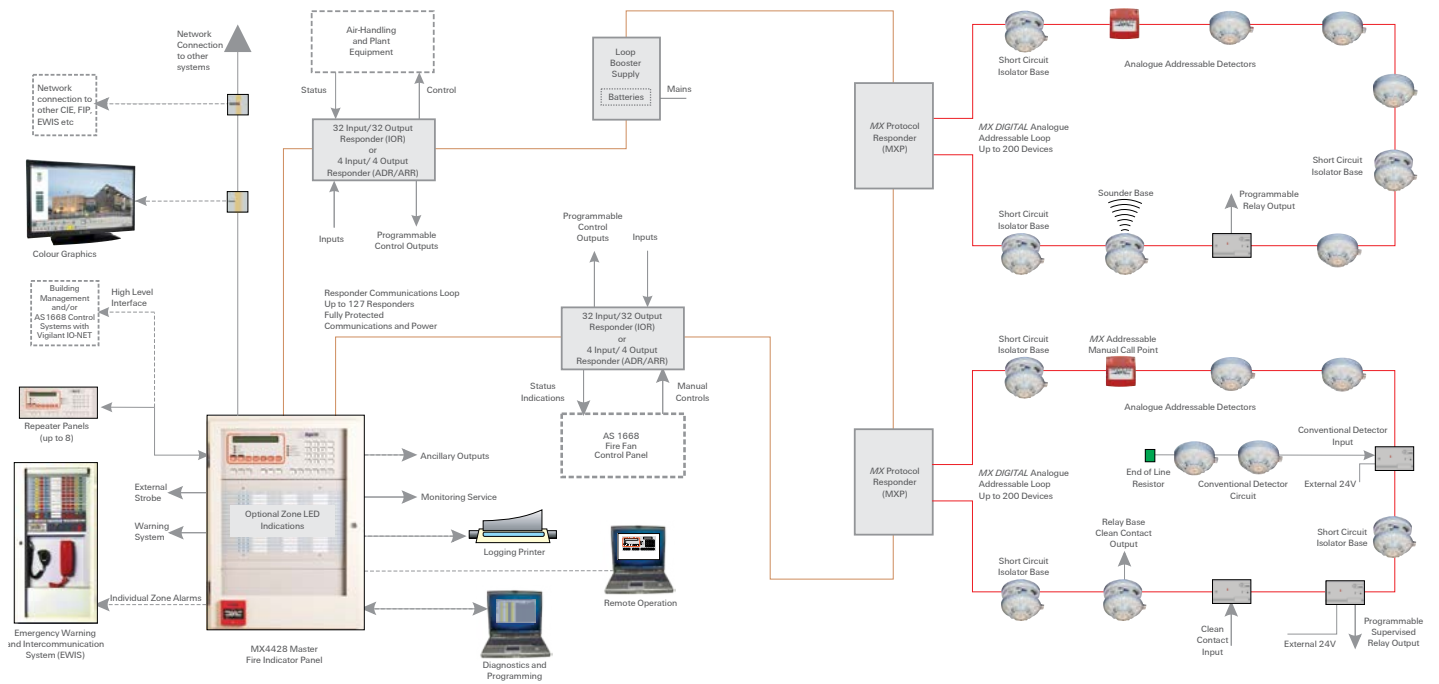

MX4428 System Diagram

Responder Loop Design

Central to the MX4428 system is the proven "Responder Loop" architecture, which allows intelligent responders to be either distributed at selected locations around the protected premises, or located centrally at the FIP. Analogue addressable loop wiring and other inputs and outputs are terminated at these responders, which in turn are connected by the 4-wire responder loop to the FIP.

The responder loop is fully protected: a partial or complete break, or short, anywhere on the loop is detected and isolated automatically at the adjacent responders. All system operations are fully maintained even in the presence of the fault condition. This design offers many benefits:

- Cable concentration at the master FIP is greatly reduced.
- Installed cost is lower because the loop design requires less wiring than conventional methods.
- Compatibility with many existing conventional and analogue addressable systems, providing a ready upgrade path.
- Ideal suitability as a main panel upgrade with old sub-panels connecting via responder inputs.
- High-integrity communications is fully supervised and protected by redundant paths.
- Loop fault sensing and isolation is provided at every responder.
- Intelligent diagnostics identifies location of faults rapidly.
- Expansion and alterations are easily accommodated with minimal additional wiring.
- Responder Loop Boosters permit virtually unlimited loop length.
- No additional multicore wiring is required for AS 1668 controls, but optional use of dedicated IO-NET (PLC) system is also possible.

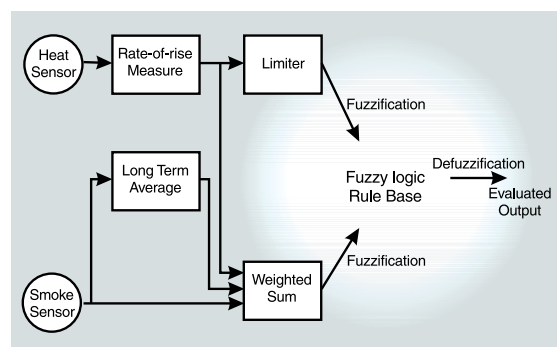

MX FASTLOGIC

Detection Algorithms

SMARTSENSE is a field-proven, reliable detection algorithm, providing unwanted alarm reduction, compensation for ambient conditions and a wide range of programmable sensitivity settings.

MX FASTLOGIC is a "fuzzy logic" based algorithm applied to photoelectric smoke and heat enhanced smoke detection, and designed to differentiate between the smoke and temperature patterns of real fires and typical causes of unwanted alarms. Both algorithms provide:

- Detector pre-alarm sensing for early warning of a potential alarm.
- Compensation for soiling and changes in ambient conditions.
- Logging "detector dirty alert" when compensation limits are about to be exceeded, to allow maintenance to be scheduled.
- Heat sensor can be programmed to act independently as a Heat Detector

MX4428 Rack Cabinet Specifications

Cabinet Size		15U	18U	21U	28U	40U
Number of extender inner doors:	Master	1	2	2	3	3
	Extender	2	2	3	4	4
Maximum number of LED displays:	Master	64	128	128	192	192
	Extender	128	128	192	256	256
Spare space at bottom:	Master	4U	0U	3U	3U	15U
	Extender	1U	4U	0U	0U	12U
Standard size gear plates (max.):		1	1	1	2	3
Overall Height (mm):		750	885	1050	1330	1865
Overall Width (mm):		550	575	575	575	575
Overall Depth (mm):		211(176 int.)	205/380	350(310 int.)	205/380	205/380 (135 or 310 internal)
Cabinet Material:		1.2mm M.S.	1.6mm M.S.	1.6mm M.S.	1.6mm M.S.	1.6mm M.S.
Cabinet Finish:		Baked epoxy powdercoat, Cream Wrinkle BFF998CW				

MX TECHNOLOGY Analogue Addressable Detectors

850PC Multi-Sensor Carbon Monoxide, Smoke and Heat Detector



For life protection and when the environmental conditions are challenging, the 850PC combined heat/smoke/CO fire detector provides the ultimate in detector performance and false alarm rejection. Outputs from multiple sensors are combined to accurately determine the presence of fire. Applications include residential, industrial, retail, transport hubs, and healthcare. Its false alarm rejection properties make it the ideal choice for hotel bedrooms where steam from bathrooms is a common source of false alarms. **Use with MX1, MX4428, 4100ESi.**

Specifications

Operating Voltage	20 to 40Vdc
Quiescent Current	370µA (typ.)
Ambient Temperature	-10°C to +55°C
Relative Humidity	15% to 90% (non-cond.)
Dimensions	109 dia x 43H mm
Weight	94g
ActivFire Listed	afp-2929
FPANZ Listed	VF/367
Part Number	516.850.054

850PH Multi-Sensor Smoke and Heat Detector



With its ability to detect a wide range of fires from flaming to smouldering types, the 850PH combined smoke and heat multi-sensor detector is the preferred choice for a range of applications including industrial, retail and office environments. It can operate in a number of approved modes and sensitivities that can be dynamically selected to suit different environmental conditions. The heat sensor monitors rate-of-rise and fixed temperature and has been tested as a fire detector in its own right. **Use with MX1, MX4428, 4100ESi.**

Specifications

Operating Voltage	20 to 40Vdc
Quiescent Current	330µA (typ.)
Ambient Temperature	-25°C to +70°C
Relative Humidity	10% to 95% (non-cond)
Dimensions	109 dia x 43H mm
Weight	76g
ActivFire Listed	afp-2930
FPANZ Listed	VF/363
Part Number	516.850.051.E

850P Smoke Detector



The 850P is a state-of-the-art smoke detector using a photoelectric sensor which, in conjunction with the MX fire alarm panel, suits most fire detection applications. The 850P incorporates a unique "mousehole" design optical chamber with superior signal to noise ratio providing high resilience to dust and dirt which means reduced service costs. In addition a unique chamber cover actually draws slow moving smoke into the chamber to provide a more responsive detector. A stainless steel insect screen is used on the 850P to provide a high degree of immunity to small insects. **Use with MX1, MX4428, 4100ESi.**

Specifications

Operating Voltage	20 to 40Vdc
Quiescent Current	330µA (typ.)
Ambient Temperature	-25°C to +70°C
Relative Humidity	10% to 95% (non-cond)
Dimensions	109 dia x 43H mm
Weight	76g
ActivFire Listed	afp-2928
FPANZ Listed	VF/362
Part Number	516.850.052.E

850H Heat Detector



The 850H is a flexible cost-effective addressable heat detector with most of the features of MX VIRTUAL detectors. The 850H reports the temperature to the MX fire alarm panel which allows various detection modes. The 850H uses a high quality thermistor with very low thermal mass. This allows the detector to function as a heat detector as well as providing a fast and accurate temperature display. **Use with MX1, MX4428, 4100ESi.**

Specifications

Operating Voltage	20 to 40Vdc
Quiescent Current	290µA (typ.)
Ambient Temperature	-25°C to +70°C
Relative Humidity	10% to 95% (non-cond.)
Dimensions	109 dia x 43H mm
Weight	81g
ActivFire Listed	afp-2927
FPANZ Listed	VF/218
Part Number	516.850.053.E

801F Flame Detector



The 801F point type flame detector presents a cost-effective solution to providing nuisance alarm free flame detection for indoor applications. The 801F is a full featured solar blind flame detector for indoor use and boasts a high degree of false alarm immunity. The 801F is designed for direct connection to the MX digital loop, employing the same universal detector base or functional base as the 850 series fire detectors. An intrinsically safe version is also available. **Use with MX1.**

Specifications

Operating Voltage	20 to 40Vdc
Quiescent Current	300µA (typ.)
Range ¹	0.4m ² n-heptane at 50m
Field of View	100°
Ambient Temperature	-20°C to +70°C
Relative Humidity	10% to 95% (non-cond)
Dimensions	109 dia x 22H mm
Weight	110g
Not ActivFire Listed	
FPANZ Listed	VF/354

Part Number 516.800.006

1. Distance measured on axis

VLC-800MX LaserCOMPACT



The VLC-800MX LaserCOMPACT detector has been specifically designed to provide all the benefits of aspirating smoke detection, including very early warning, in single small areas and where space is a premium. The VLC-800MX communicates directly with the MX4428 CIE via the MX loop detecting smoke by using proven VESDA aspirating technology, dual stage filtration technology in combination with the versatility of the MX4428 CIE. The VLC-800MX utilises a standard VESDA pipe design in accordance with the Aspire design tool. Refer to the VESDA section for accessories. **Use with MX1, MX4428.**

Specifications

External Supply	18 to 30Vdc
Quiescent Current	225mA
Alarm Current	245mA
Ambient Temp	
Sensor Ambient	-10°C to +39°C
Sampled Air	-20°C to +60°C
Relative Humidity	10% to 95% (n/cond)
Alarm Sensitivity	0.005 to 20%Obs/m
Coverage Area	800 m ²
Dimensions (HWD)	225x225x85mm
Weight	1.9 kg
ActivFire Listed	afp-1580
FPANZ Listed	VF/341

Part Number VLC-800MX

D51MX Duct Sampling Unit

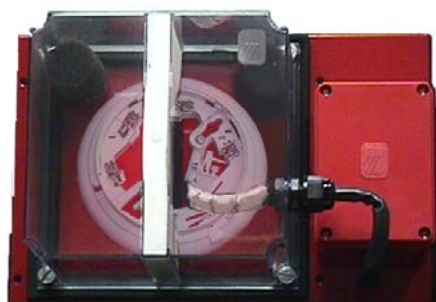

The D51MX consists of a D51 duct sampling housing fitted with a 4B base wired to suit an MX analogue addressable 850P/814P or 850PH/814PH photoelectric smoke detector. When fitted with the detector the DSU is designed to sample air in air conditioning ducts and pass the air through the smoke detector. The D51MX is fitted on the outside of the duct to be sampled allowing easy access for detector servicing and replacement of the dust filters. To cater for most duct sizes, a sampling tube extension is available in 3 metre lengths. The VIGILANT E500 Mk2 Series Remote Indicators can be used for remote indication of an alarm. **Use with MX1, MX4428, 4100ESi.**

Part Numbers

D51MX	Duct Sampling Unit
D51L	Baffle box of 10
D51F	Filter box of 10
D51T3	3m Sampling Tube
D51K100	Sampling Tube End Cap (pkt of 10)

Specifications

Operating Voltage	20 to 40Vdc
Quiescent Current	275µA (typ.)
Alarm Current	10mA with LED on
Duct Pressure ¹	-1.15 to +3.0 kPa
Duct air velocity for alarm at 8%Obs/m ¹	1, 2, 4, 8m/s
Sampling Tube Length	160mm minimum
Max. Duct Width	1.8m
Remote Indicator	E500 Mk2 Series
Dimensions	
Base & Cover (LWH)	278x190x113 mm
Sampling Tube Pitch	122mm
Duct Holes Required	24mm dia. x 2 plcs
Ambient Temp	-10°C to +55°C
Relative Humidity	10% to 95% (n/cond)
ActivFire Listed ²	afp-1496

1. AS 1603.13-1998 test 2. Listed with 814PH

MCP820 Addressable Call Point



The MCP820 Addressable Manual Call Point is suitable for indoor applications. As supplied, it is suitable for flush mounting. A surface mounting back box is available separately. The MCP820 is designed to monitor and signal the condition of the switch contact that is operated by breaking a plastic coated glass frangible element (flexible plastic option available). Any change in the status of the switch is immediately communicated to the Control and Indicating Equipment (CIE). The MCP820 has an integral short-circuit isolator for protecting the addressable loop wiring.
Use with MX1, MX4428.

The CP820 is an alternative MX addressable call point which does not have an integral short circuit isolator.
Use with MX1, MX4428, 4100ESi.

Specifications

Operating Voltage	20 to 40Vdc
Quiescent Current	275µA (max.)
Alarm Current	2.8mA (max. LED on)
Indoor Applications Only	
Relative Humidity	10% to 95% (n/cond)
Ambient Temperature	-25°C to +70°C
Dimensions (HWD)	87x87x52 mm
Weight	170g
Ingress Protection	IP24D
ActivFire Listed	afp-1503 (CP820) afp-2874 (MCP820)

Part Numbers

CP820	CP820 only
514.800.611	MCP820 only
SU0632	Backbox
515.001.025	Spare Glass (pkt 5)

MCP830 Addressable Waterproof Call Point



The MCP830 Addressable surface mounting Manual Call Point has an International Protection rating of IP67, making it suitable for outdoor applications. It is designed to monitor and signal the condition of the switch contact that is operated by breaking a plastic coated frangible glass element (flexible plastic option available). Any change in the status of the switch is immediately communicated to the Control and Indicating Equipment (CIE). The MCP830 has an integral short-circuit isolator for protecting the addressable loop wiring. Note MCP830 does not have a formal UV exposure rating. Installation in full sun should be avoided.

The CP830 is an alternative IP67 MX addressable call point which does not have an integral short circuit isolator. **Use with MX1, MX4428.**

Specifications

Operating Voltage	20 to 40Vdc
Quiescent Current	275µA (max.)
Alarm Current	2.8mA (max. LED on)
Indoor Applications Only	
Relative Humidity	10% to 95% (n/cond)
Ambient Temperature	-25°C to +70°C
Dimensions (HWD)	93x98x73 mm
Weight	240g
Ingress Protection	IP67
ActivFire Listed	afp-2798 (CP830) afp-2875 (MCP830)

Part Numbers

514.800.604.Y	CP830 & Backbox
514.800.612	MCP830 & B'box
515.001.119	Spare Glass (pkt 5)

MX Loop Filter (Interference Suppression)



The MXP Loop Filter board is available for fitting to an MXP in order to further improve common-mode interference suppression that may occur as a result of the MXP detector loop not being adequately separated from power wiring, lift motors etc. **Use with MX1, MX4428, 4100ESi.**

Specifications

Operating Supply	20 to 40Vdc
Dimensions (HWD)	70x20x25mm

Part Number

PA1038

MX Loop Tester

The MX Loop Tester can test, commission and fault-find a loop of up to 250 MX digital addressable detectors/devices, without a fire panel. A laptop is generally used for operation & display, but a "One Person Installation Mode" is automatically enabled on power up. The MX Loop Tester identifies all devices on the loop, determining addresses and types. Over-addressed (>250), unknown device types, and, generally, duplicate addressed devices are recognised. Monitors analogue values of all detectors/modules on the loop to determine device status: normal/alarm/fault/dirty etc.



Provides alarm test for detectors that support it. The MX Loop Tester allows Walk Test. Any device going into alarm is shown on the laptop with address and time. Walk Test Status (devices not tested yet) can be requested. Walk test mode overrides detection algorithm delays for fast testing.

The MX Loop Tester monitors loop current and status, identifying open / short and over-current conditions and can detail devices present on each side of break (so that position of break or tripped isolator can be determined).

The MX Loop Tester includes commands to operate device LED and control output modules (relays and sounders), and can turn on LED of faulty detectors (when there is no alarm) to aid visual identification.

Automatic addressing mode allows un-programmed devices to be added in sequence and be automatically addressed.

Detailed diagnostics and commissioning modes are accessed via laptop PC.

Use with MX1, MX4428.

Specifications

Power Source	24V batteries or 230VAC to 24V/3A plug pack
Dimensions ¹ (HWD)	220x122x46mm
Dimensions ² (HWD)	250x250x70mm
Weight ³	2kg

Part Numbers⁴

FP0898	Aus/NZ version
SU0256	90-264VAC to 24Vdc Adaptor Plug Pack

1. Unit only 2. Carry Bag 3. Excluding batteries
4. FP0898 includes test unit, carry bag, 230VAC plug pack, manual and loom.

850EMT MX Engineering Management Tool



The 850EMT is used to program the address into MX addressable devices. When used with VIGILANT MX1 systems, the 850EMT can also remotely interrogate, address and test 850 Series detectors via a two-way infrared link. It also displays information and performs tests on devices. It has a touch screen backlit colour LCD and four 'softkeys', ESC, OK, Up and Down. Power for the 850EMT is derived from 6 AA size NiMH rechargeable batteries. It may be run from an unregulated +12Vdc input i.e., car power outlet or 110/230VAC mains adaptor, both of which will recharge the batteries as well.

The 850EMTK consists of the following:

- 850EMT MX Service Tool
- Ancillary programming lead & spare pins
- 6 x rechargeable AA size NiMH batteries
- 240VAC Adaptor plus Lead
- 12Vdc car adaptor
- Hard Carry Case

Use with MX1, MX4428, 4100ESi.

Specifications

Batteries	6xAA NiMH
Batt. Operating Time	up to 15 hours
Ambient Temp	0 to +50°C
Relative Humidity	10% to 90% (n/cond)
Dimensions ¹ (HWD)	50 x 210 x 125mm
Weight ¹	600g incl. batteries

Part Numbers

850EMTK	Service Tool Kit
516.800.922	Ancillary Lead
516.800.923	Carry Case & Acc (345 x 310 x 85 mm)
516.800.924	Ancillary Lead Spare Pins

1. For 850EMT unit only

Address Flag

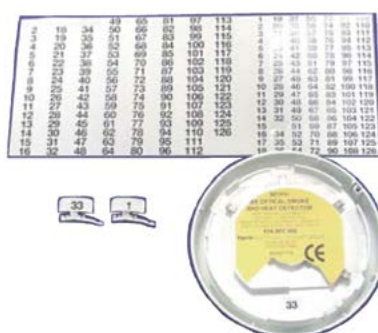

The 800 Series detectors incorporate a feature which automatically transfers the address flag to the detector base when the detector is plugged into the base. On removal of the detector the address flag remains on the ceiling, thus helping to ensure that detectors are not accidentally returned to the wrong detector base following service routines. Address flags are supplied in packs of 100. Labels are provided on sheets of 250 in four colours to enable quick identification between different loops.

Part Numbers

516.800.915	MX Address flags (pk of 100)
516.800.931	Address flag lbl Loop A - Wht
516.800.932	Address flag lbl Loop B - Yel
516.800.933	Address flag lbl Loop C - Ppl
516.800.934	Address flag lbl Loop D - Grn

Standard Detector Bases

4B Universal Base



The 4B Universal Base contains no electronics and is suitable for indoor applications of the 614 series conventional (non-addressable), 814 and 850 series analogue addressable detectors. It provides excellent space for cable access and terminations.

It features remote LED connections and an anti-tamper facility. The 4B base is designed to snap-fit into the ceiling tile adaptor, or screw fix to the ceiling in the traditional manner. The 4B-6A Adaptor covers ceiling marks revealed when changing from an existing 5" or 6" base. The Euro Mount Adaptor is a shallow (20mm deep) back box for surface mounting applications.

When (suitable) detectors are fitted in damp or dirty environments, the 4B-DHM Deckhead Mounting provides an IP55 seal between the mount and the detector base. Use with MX4428.

Specifications

Operating Temp.	-25°C to +75°C
Relative Humidity	10% to 95% (non cond.)
Dimensions (mm)	109 dia x 25H
Weight	64g

Indoor Applications Only
ActivFire Listed with compatible detectors

Part Numbers

517.050.041	4B Base
517.050.052	Euro Mount Adaptor
517.050.056	4B-6A 4" to 6" Adaptor
517.050.051	4B-DHM DeckHead Mounting Kit

4B-C Continuity Base



The 4B-C Continuity Base is used for most installations involving 850 Series detectors, as it allows the detector's in-built short circuit isolation function to be in-circuit when the detector is fitted and ensures continuity is maintained when the detector is removed. Use with MX1, 4100ESi.

Specifications

Ambient Temperature	-25°C to +70°C
Relative Humidity	10% to 95% (n/cond)
Dimensions (mm)	109 dia x 25H
Weight	64g

Indoor Applications Only
ActivFire Listed with MX detectors

Part Number 517.050.042

1. Maximum number of devices between 5BI bases is limited to 40 for AS 1670.1-2004 systems.

Functional Detector Bases

800 Series Functional Detector Bases supplement the standard universal detector base, providing sounder, relay, and loop isolation functions for the range of MX CIE. Changes to a building can easily be adapted to by retrofitting sounders and relays to existing points. Refer to Page 119 Sounder Base Selection Guide.

4B-I Isolator Base



The 4B-I Isolator Base serves as both a base for an 814 or 850 Series *MX* detector and a protection device against loop short circuits, monitoring the voltage on the *MX* addressable loop. When a short circuit is detected, the 4B-I isolates the affected section whilst allowing the rest of the addressable loop to function normally. If a detector fitted to the 4B-I exhibits a short circuit, the 4B-I will isolate both sides of the loop from the faulty device without affecting any other device on the loop. An amber LED indicator on the rim of the base illuminates whenever the short circuit isolator is activated. The 4B-I can accommodate one of the *MX* detectors, or serve as a base for an 814RB. **Use with *MX1*, *MX4428*, *4100ESi*.**

Specifications

Operating Voltage	20 to 40Vdc
Quiescent Current	80µA (max.)
Tripped Current	3.5mA (max.)
IB Units betwn 4B-I bases	100 (max.) ¹
<i>Indoor Applications Only</i>	
Ambient Temperature	-25°C to +70°C
Relative Humidity	10% to 95% (n/cond)
ActivFire Listed with <i>MX</i> detectors	
FPANZ Listed	VF/650

Part Number 517.050.043

1. Maximum number of devices between 4BI bases is limited to 40 for AS 1670.1-2004 systems.

Ceiling Tile Adaptor



The Ceiling Tile Adaptor (CTA) is used to prepare a ceiling tile to be able to accept a complete base and detector assembly. It comprises a Bezel (1), Clamp (2) and Back Box (3). Traditionally the detector base is installed without the detector head, as mounting screws must be inserted through the back plate of the base. The CTA can save time by allowing a system to be installed and commissioned before the ceiling is installed. Once the ceiling is installed the base and detector assembly can be pulled into place without the need for disassembly and re-testing. **Use with *MX1*, *MX4428*, *4100ESi*.**

Specifications

Dimensions (H x Dia)	52 x 165 mm
Weight	232g
Ceiling Cutout	127mm (30mm max. tile)
Material	Flame Retardant ABS
Colour	White
Ambient Temperature	-25°C to +70°C
Storage Temperature	-40°C to +80°C
Relative Humidity	10% to 95% (non cond.)

Part Numbers

517.050.060	Ceiling Tile Adaptor Kit
- 517.050.056	Back Box
- 517.050.057	Bezel and Clamp
517.050.058	CTA-AP Ceiling Tile Sounder Base Adaptor Plate (8x111 dia.- not shown)

Addressable AS7240 Visual Alarm Detector Bases

P80AVB & P81AVB Addressable Sounder VAD Bases



Main Requirements from AS7240-23 are:

- The coverage volume (i.e. volume within which required illumination is achieved) must be stated on the product or supporting documentation.
- The VAD should meet the requirement for coverage volume of at least one of the following categories: W (Wall), C (Ceiling), O (Open Class).
- Required illumination of 0.4 lux on a surface perpendicular to the direction of the light emitted from the VAD.
- Rate of flash should be stated between 0.5Hz & 2Hz.
- The devices must be classified as Type A, indoor and Type B, outdoor

Features:

- A compact and discrete solution
- VAD approved to AS7240-23 two models P80AVB standard intensity and P81AVB high intensity flash
- Shorter light pulse for faster response
- Optimise the system design for lowest power requirements and lowest cost installation
- Triple light source
- One point of installation for detector, sounder and visual indicator with no additional wiring
- Independent addressable control of the sounder and beacon
- Built-in line isolator
- Select the tone, volume and flash rate using panel configuration software
- 15 selectable tones. Allows users to select the tone with which they are most familiar
- Realistic conventional bell tone
- 2 selectable volumes
- 2 selectable flash rates
- Different tones can be used for fire alarm and class change
- VADs and sounders are synchronised over each MX loop
- A locking pin supplied with the base which prevents the unauthorized removal of the detector

Part Numbers

576.080.006	P80AVB Addressable Base Sounder VAD Standard Intensity
576.080.014	P81AVB Addressable Base Sounder VAD High Intensity
557.080.001	B-CAP Blanking Cap For Sounder / VAD Bases White
557.080.002	A-CON Conduit Adaptor For Sounder / VID / VAD Bases White

Sounders are considered as the most important of all the alarm devices. It is a mandatory requirement that sounders are used as an integral part of the fire detection and alarm system. VADs are used to supplement sounders, providing an effective means of alerting and evacuating occupants of the building, as part of its fire safety strategy.

The P80AVB and P81AVB are indoor addressable sounder bases with a Visual Alarm Device (VAD) specifically for use with the MX addressable detectors. The P81AVB includes a higher intensity visual indication for more coverage compared to the P80AVB.

Each has an address so they can be monitored and controlled from the fire alarm control panel, which is independent of the detector fitted to the base. The power and communications for the sounder, VAD and detector are provided by the two-wire MX digital loop. This helps to reduce installation costs as no additional wiring is required. AS7240-23 now provides clarity by standardizing requirements, test methods and performance criteria of Visual Alarm Devices (VADs) and ensures all device parameters are measured in a uniform manner throughout Australia.

Technical Information

	P80AVB	P81AVB
Coverage Volume Code	C-3-8	C-3-15
Devices per loop	Up to 86 (*)	Up to 54 (*)
Flash rate	0.5 / 1Hz	0.5 / 1Hz
Dimensions (Diameter x H)	135x45mm	135x45mm
Sound output @ 1m	Up to 90dBA	Up to 90dBA
Body colour	Clear	Clear
Flash Colour	White	White
IP Code	IP21C	IP21C
Approvals	AS7240-3, 23, 17	AS7240-3, 23, 17

Wall Category:

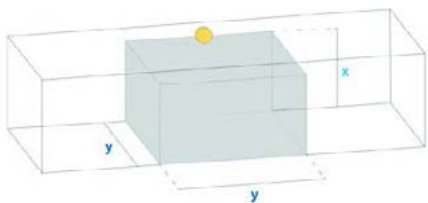

Coverage volume code:

W - (x) - (y)
W = wall mounted

x = maximum mounting height

y = length and width in metres of the cubic volume covered (to a minimum level of 0.4 lux) when the device is mounted to the wall at a height of x

Ceiling Category:

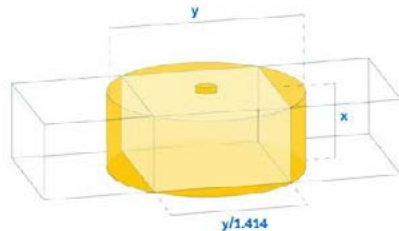

Coverage volume code:

C - (x) - (y)
C = wall mounted

x = maximum mounting height

y = diameter in metres of the cylindrical volume covered (to a minimum level of 0.4 lux) when the device is mounted to the ceiling at a height of x

P80SB Addressable Sounder Base



Sounders are considered as the most important of all the alarm devices. It is a mandatory requirement that sounders are used as an integral part of the fire detection and alarm system.

The P80SB is an indoor addressable sounder base specifically for use with the MX addressable detectors. The base incorporates a sounder that carries its own address so it can be monitored and controlled from the fire alarm control panel, which is independent of the detector fitted to the base. Both power and communications for the sounder and detector are provided by the two-wire digital loop. This helps to reduce installation costs as no additional wiring is required.

Features:

- A compact and discrete solution
- One point of installation for detector, sounder
- Independent addressable control of the sounder
- Built-in line isolator
- 15 selectable tones. Allows users to select the tone with which they are most familiar
- 2 selectable volumes

Part Numbers

576.080.002	P80SB Addressable Base Sounder
557.080.001	B-CAP Blanking Cap For Sounder / VAD Bases White

Technical Information

	P80SB
Devices per loop	Up to 231 (*)
Flash rate	N/A
Dimensions (Diameter x H)	114x45mm
Sound output @ 1m	Up to 90dBA
Body colour	White
Flash Colour	N/A
IP Code	IP21C
Approvals	AS7240-3, 17

(*) Sounder at high volume, 1 A loop.

(**) Beacon at 0.5 Hz with sounder at high volume, 1 A loop.

Loop quantities are for guidance only and should be verified with the loop calculator.

80DSB Detector Sounder Base / Detector Activated Sounder Base



Sounders are considered as the most important of all the alarm devices. It is a mandatory requirement that sounders are used as an integral part of the fire detection and alarm system.

The 80DSB is an indoor detector base specifically for use with the MX addressable detectors. The base incorporates a sounder that is activated directly by the detector plugged into the base.

Technical Information

	P80DSB
Devices per loop	Up to 250 (*)
Dimensions (Diameter x H)	114x45mm
Sound output @ 1m	Up to 90dBA
Body colour	White
IP Code	IP21C
Approvals	AS7240-3

(*) Sounder at high volume, 1 A loop.

Loop quantities are for guidance only and should be verified with the loop calculator.

Part Numbers

576.080.001	80DSB Detector Base Sounder
557.080.001	B-CAP Blanking Cap for Sounder / VAD Bases White
557.080.002	A-CON Conduit Adaptor for Sounder / VAD Bases White

Features:

- A compact and discrete solution
- One point of installation for detector and sounder with no additional wiring
- Low power with up to 175 sounders on a single loop
- Simple to select the tone and volume using switches
- No special training or tools needed
- 9 selectable tones
- 4 selectable volumes
- A locking pin is supplied with the base which prevents the unauthorized removal of the detector
- Replaces legacy 802SB and it is compatible with 800 series detectors. Can be used for service and repair or as part of a planned upgrade path.

AS7240 Visual Alarm Devices

P80AVW, P80AVR Addressable Wall Sounder VADs



Sounders are considered as the most important of all the alarm devices. It is a mandatory requirement that sounders are used as an integral part of the fire detection and alarm system.

VADs are used to supplement sounders, providing an effective means of alerting occupants of the building, as part of its fire safety strategy.

The P80AV range of compact addressable wall sounders with a Visual Alarm Device (VAD) includes two models with the same low current and high output specification; red and white body indoor models.

Features:

- A compact and unobtrusive sounder solution
- Shorter light pulse for faster response
- Can be semi-flush or surface mounted including a choice of shallow or deep back box
- Power and data from MX loop. No additional wiring or power supplies required
- Built-in line isolator
- 16 selectable tones
- Realistic conventional bell tone
- 2 selectable volumes
- 2 selectable flash rates
- Select the tone, volume and flash rate using panel configuration software
- Independent addressable control of sounder / beacon
- Different tones available for fire alarm and class change
- Aesthetically pleasing wall mount option
- A locking pin/screw supplied

Part Numbers

576.080.007	P80AVW Addressable Wall Sounder VAD White
576.080.008	P80AVR Addressable Wall Sounder VAD Red
557.080.007	S-BOXR Shallow Surface Back Box For Wall Sounder / VAD Red
557.080.008	S-BOXW Shallow Surface Back Box For Wall Sounder / VAD White
557.080.010	A-BOX Flush Back Box Adaptor For Indoor Wall Sounder / VAD
557.080.011	D-BOXR Deep Surface Back Box For Wall Sounder / VAD Red
557.080.012	D-BOXW Deep Surface Back Box For Wall Sounder / VAD White

Technical Information

	P80AVW	P80AVR
Coverage Volume Code	W-2.4-7.5	W-2.4-7.5
Devices per loop	Up to 73 (*)	Up to 73 (*)
Flash rate	0.5 / 1Hz	0.5 / 1Hz
Dimensions (WxHxD)	89x135x40mm (Without backbox)	89x135x40mm (Without backbox)
Sound output @ 1m	Up to 100dBA	Up to 100dBA
Body colour	White	Red
Flash colour	White	White
IP Code	IP21C	IP21C
Approvals	AS7240-3, 23, 17	AS7240-3, 23, 17

(*) Full intensity VAD with sounder at high volume, 1 A loop.

Loop quantities are for guidance only and should be verified with the loop calculator.

Wall Category:

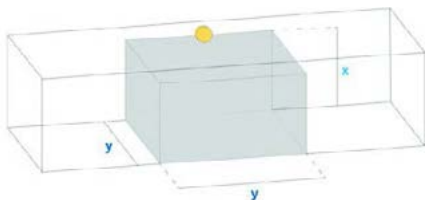

Coverage volume code:

W - (x) - (y)
W = wall mounted

x = maximum mounting height

y = length and width in metres of the cubic volume covered (to a minimum level of 0.4 lux) when the device is mounted to the wall at a height of x

Ceiling Category:

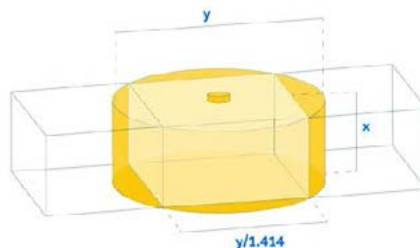

Coverage volume code:

C - (x) - (y)
C = wall mounted

x = maximum mounting height

y = diameter in metres of the cylindrical volume covered (to a minimum level of 0.4 lux) when the device is mounted to the ceiling at a height of x

MX TECHNOLOGY Analogue Addressable Modules

CIM800 Contact Input Module

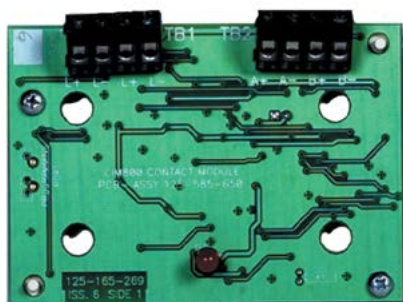

The CIM800 Addressable Contact Input Module monitors and supervises two circuits of voltage-free contacts such as outputs from extinguishing systems, ventilation controls, fire door controls,

sprinkler flow switches, non-indicating hard contact detectors, etc. The LED illuminates when any input goes into alarm and can be programmed to blink when polled by the CIE. The CIM800 can be configured to monitor:

- Two circuits of multiple N/O contacts; with short circuit alarm.
- Two circuits of multiple N/C contacts; open circuit alarm.
- Two circuits with a single N/O contact closing for alarm; with short circuit fault. (Requires a resistor in series with the alarm contact and special c.i.e. programming).

The two circuits may be recognised as a single point (MX4428) or two separate points (MX1). Refer to the specific MX fire alarm panel specification. **Use with MX1, MX4428, 4100ESi.**

Specifications

Operating Voltage ¹	20 to 40Vdc
Quiescent Current	275µA (max.)
Alarm Current	2.8mA (max, LED on)
Circuit Resistance	10 Ohm (max.)
ELD Resistor	200 Ohm (supplied)
Alarm Resistor	100 Ohm (s/c fault)
Ambient Temperature	-25°C to +70°C
Relative Humidity	10% to 95% (n/cond)
Dimensions (HWD)	61 x 84 x 25mm
ActivFire Listed	afp-3164
FPANZ Listed	VF/640
Part Number	CIM800

1. MX addressable loop voltage

DDM800 Universal Fire & Gas Detector Module



The DDM800 Detector Module designed to monitor and signal alarms from
 * one or two conventional 2-wire circuits
 * one or two 4-20mA sensors (MX4428 only).

The DDM800 may be used to connect two circuits of conventional 20V detectors and interface them with an MX addressable fire alarm system.

The DDM800 can be loop powered and use the VIGILANT 614 series detectors, or use an external 24Vdc supply allowing a wide range of detectors to be used - and be electrically isolated from the MX loop.

In 4-20mA mode the DDM800 can support a single 4-20mA source on each circuit, operating in either current sink or current source mode. **Use with MX1, MX4428, 4100ESi.**

Specifications

Operating Voltage ¹	20 to 40Vdc
Quiescent Current	1.5mA (LV. mode)
Loop Alarm Current	2.8mA (max.)
Ambient Temp	-25°C to +70°C
Relative Humidity	10% to 95% (n/cond)
Detector Load	3mA (max per input)
Detector ELD	4k7 Ohm
External Supply ²	21.9 to 29Vdc
Ext. Current/Circuit	10mA (+ Det. Load)
Ext. Alarm Current ³	52mA
Dimensions (HWD)	61 x 84 x 25mm
ActivFire Listed	afp-3173
FPANZ Listed	VF/666
Part Number	577.800.006

1. MX addressable loop voltage

2. Voltage restrictions for some detectors

3. External Supply Alarm / Short Circuit

DIM800 Detector Input Module

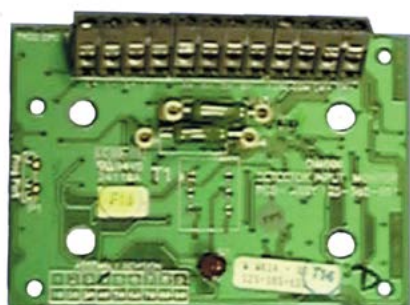

The DIM800 Detector Input Module interfaces two collective detector circuits onto the MX addressable loop.

Each circuit can support 3mA of detector quiescent current and requires a 4k7 Ohm End Of Line resistor. The two circuits may be recognised as a single point (MX4428) or two separate points (MX1). Refer to the specific MX fire alarm panel specification.

Unused circuits must be terminated with an ELD resistor.

The DIM800 requires a suitably rated and separately protected external 24V supply to power the detector circuits. **Use with MX1, MX4428, 4100ESi.**

Specifications

Operating Voltage ¹	20 to 40Vdc
Quiescent Current	280µA (max.)
Loop Alarm Current	2.8mA (max.)
Ambient Temp	-25°C to +70°C
Relative Humidity	10% to 95% (n/cond)
Detector Load	3mA (max per input)
Detector ELD	4k7 Ohm
External Supply ²	20 to 28.7Vdc
Ext. Current/Circuit	7.5mA (normal)
Ext. Alarm Current ³	30 to 50mA
Dimensions (HWD)	61 x 84 x 25mm
ActivFire Listed	afp-3179
FPANZ Listed	VF/643
Part Number	DIM800

1. MX addressable loop voltage

2. Voltage restrictions for some detectors

3. External Supply Alarm / Short Circuit

LIM800 Line Isolator Module

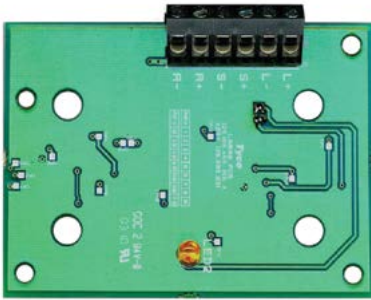

The LIM800 Line Isolator Module is designed to be used on the *MX* addressable controller loop circuits. It monitors the line condition and when detecting a short circuit will isolate the affected section whilst allowing the rest of the addressing circuit to function normally.

The purpose of the LIM800 Line Isolator Module is to ensure that, on a looped addressable system, no short circuit fault can disable more detection devices than would be lost on a conventional non-addressable fire circuit.

Use with *MX1*, *MX4428*, *4100ESi*.

Specifications

Operating Voltage ¹	20 to 40Vdc
Current Loading	
Input Current	80µA max. (normal) 3.5mA max. (tripped)
Max. Series Resistance ²	0.25 Ohm
Ambient Temp	-25°C to +70°C
Relative Humidity	10% to 95% (n/cond)
Dimensions (HWD)	61 x 84 x 25mm
ActivFire Listed	afp-3170
FPANZ Listed	VF/657
Part Number	545.800.004

1. *MX* addressable loop voltage.
2. Isolator normal.

MIM800/MIM801 Mini Input Modules



The MIM800 Mini Input Module monitors a voltage-free contact and transmits its state to the c.i.e. It can be programmed to monitor either Normally Open (default) or Normally Closed contacts. The MIMs can be programmed to monitor:

- One circuit of multiple N/O contacts, with short circuit alarm.
- One circuit of multiple N/C contacts, with open circuit alarm.
- One circuit with a single N/O contact, closing for alarm, with fault detection for short circuit.

The MIM801 is also available; it is optimised for normally closed applications and can generate an interrupt (only used when a fast response is required) on an open circuit. The MIM800 can operate an E500 Mk2 Series Remote Indicator.

The input wiring must be as short as possible (less than 1m) and located well away from all electrical noise sources.

Use with *MX1*, *MX4428*, *4100ESi*.

Specifications

Operating Voltage ¹	20 to 40Vdc
Quiescent Current	275µA (typ)
Alarm Current	2.8mA (max, LED on)
Circuit Resistance	10 Ohm (max.)
ELD Resistor	200 Ohm (supplied)
Alarm Resistor	100 Ohm (s/c fault)
Ambient Temp	-25°C to +70°C
Relative Humidity	10% to 95% (n/cond)
Dimensions (HWD)	57 x 48 x 13mm
ActivFire Listed	afp-3165 (MIM800) VF/641 (MIM800) VF/645 (MIM801)
FPANZ Listed	E500 Mk2 Series

Remote Indicator

Part Numbers

MIM800	MIM800 (Aus/NZ)
FP0837	MIM801 (NZ)

1. *MX* addressable loop voltage

MIO800 Multi-Input Output Module



The MIO800 Multi-Input Output Module allows multiple input and output connections to be made between external equipment and the *MX DIGITAL* loop. Three inputs and two outputs are provided. Each input and output can be programmed independently to provide customised functionality.

An IP55 rated D800 style housing can be used as the standard enclosure, with the option of a DIN-rail mounting kit for in-cabinet installation.

Use with *MX1*, *4100ESi*.

Specifications

Operating Voltage ¹	20 to 40Vdc
Quiescent Current	480µA (max.)
Alarm Current	3mA (max, LED on)
Relay Contact	2A @ 24Vdc (max.)
Ambient Temp	-25 to +70°C
Relative Humidity	10% to 95% (n/cond)
Dimensions (HWD)	72 x 110 x 18mm
ActivFire Listed	afp-3166
FPANZ Listed	VF/655

Part Numbers

555.800.065	MIO800 (Aus)
MIO800	MIO800 (NZ)

1. *MX* addressable loop voltage

QIO850/QMO850/QRM850 Quad I/O Modules

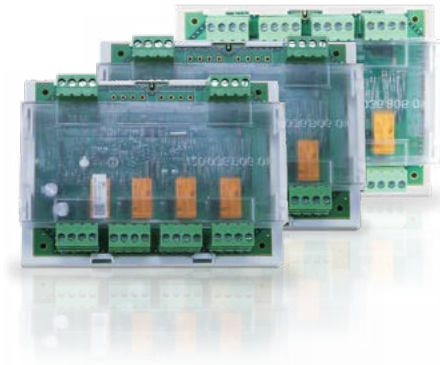

The MX Quad Ancillary Modules form a versatile new range of multiple input and output modules for use with MX TECHNOLOGY systems¹.

QIO850 – Quad Input / Output module – provides four monitored inputs and four relay outputs

QMO850 – Quad Monitored Output module – provides four monitored outputs

QRM850 – Quad Relay Output Module – provides four relay outputs

The modules are ideal for applications such as:

- AS 1668 fan control interfaces
- Plant or security outputs, or when large numbers of inputs and/or outputs are required. **Use with MX1.**

Features common to the Quad Modules are:

- Built-in MX loop short-circuit isolator with fault indication at the MX1 CIE¹ when operated
- IR link for programming by 850EMT
- Selectable interrupt operation to speed up response
- Enclosed in protective plastic housing, with an optional IP66 enclosure available for applications in challenging environments
- Top-hat DIN rail mounting
- LED indication of each output state
- 24V/48V link selectable Auxillary supply for outputs
- Supervision of Auxillary supply for presence
- Fault indication of stuck relay contacts – not operating when switched on.

Specifications

	QIO850	QMO850	QRM850
MX Loop Voltage		20–40Vdc	
Quiescent Current	0.58mA	1.2mA	0.58mA
Alarm Current	3.6mA	4.2mA	3.6mA
Relay Output		2A@30Vdc	
Aux. Voltage Input		20–55Vdc	
Input States	Short cct	–	–
	Alarm	–	–
	Normal	–	–
	Open cct	–	–
	3k3 Ohm	–	–
Input EOL			
Dimensions (HWD)		134 x 103 x 49 mm	
Weight		232g	
Ambient Temp.		–25°C to +70°C	
Storage Temp.		–40°C to +80°C	
Relative Humidity		10% to 95% (n/cond.)	
ActivFire Listed	afp-3174	afp-3177	afp-3175
FPANZ Listed	VF/669	VF/668	VF/670
Part Numbers			
Modules	555.800.071	555.800.070	555.800.073
IP66 Enclosure	557.201.410	557.201.410	557.201.410

1. The MX Quad Ancillary Modules are not supported by the MX4428 CIE.

RIM800 Relay Interface Module

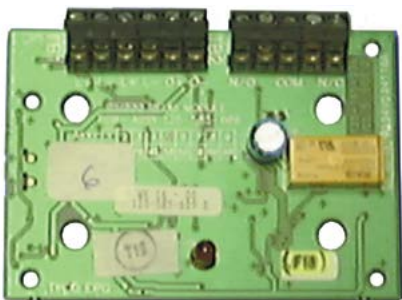

The RIM800 Relay Interface Module provides one volt-free changeover contact which is not supervised. The relay is controlled by a command sent from the CIE via the addressable loop and may be used to signal a state to other systems (security systems, for example) or to energise loads such as Door Holders. The relay operation is determined by the CIE programming. The RIM800 has a red LED which may be configured to indicate relay activation and CIE polling. Note that the RIM800 cannot be used to switch mains voltage directly. **Use with MX1, MX4428, 4100ESi.**

Specifications

Operating Voltage ¹	20 to 40Vdc
Quiescent Current	285µA (max.)
Alarm Current	2.8mA (max, LED on)
Relay Contact	2A @ 30Vdc (max.)
Ambient Temp	–25 to +70°C
Relative Humidity	10% to 95% (n/cond)
Dimensions (HWD)	61 x 84 x 25mm
ActivFire Listed	afp-3167
FPANZ Listed	VF/642
Part Number	RIM800

1. MX addressable loop voltage

SAB801 Sounder Addressable Beacon & SAM800 Sounder Addressable Module



SAB801

SAM800

The Sounder Addressable Beacon SAB801 and Sounder Addressable Module, SAM800 are designed to control an MX loop powered sounder base or relay base for use with compatible MX CIE. The SAB801 has an integral high intensity red LED beacon that can be separately controlled to the base. The beacon can be configured to illuminate continuously or flash at 1Hz, although there is no facility to synchronise several SAB801 beacons. The SAB801 and SAM800 supply the address decoding in place of a detector, thus providing a remotely controlled beacon and sounder when used in conjunction with an 802SB. **Use with MX1, MX4428.**

Specifications

	SAB801	SAM800
Quiescent Current		250µA
Alarm Current	325µA	250µA ¹
Max. device/Loop ²		200/250
Flash Rate	Cont. or 1Hz	–
Dims (Dia.x H mm)	108 x 32	108 x 22
Weight		70g
Ambient Temp.		–10°C to +55°C
Relative Humidity		10% to 96% (non-cond.)
Not ActivFire Listed		
FPANZ Listed	VF/420	VF/656
Part Numbers	516.800.956	516.800.954
(NZ Only)	SAB801	SAM800
Sounder Cap Mk2		557.001.040

1. In addition to associated sounder/relay current.

2. Maximum number of devices between 4BI bases is limited to 40 for AS 1670.1–2004 systems.

SIO800 Single Input/Output Module

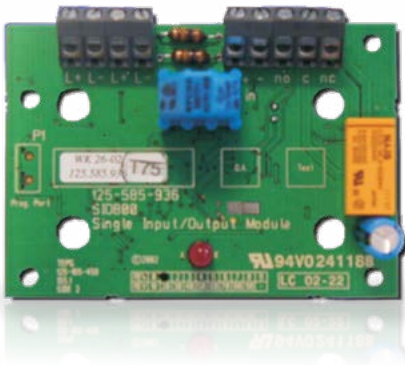

The SIO800 Addressable Single Input/Output Module is an *MX* addressable module that provides one clean contact input and a voltage-free changeover relay output. The input supports normally-open or normally-closed contacts and short/open circuit faults – depending on the input mode selected by the Control and Indicating Equipment (CIE). The relay is controlled by a command sent from the CIE via the *MX* addressable loop. The LED illuminates when the input goes into alarm, and can also be programmed to blink when polled by the CIE. The *MX1* CIE supports the following modes for the input circuit:

- Normally-open contact, closing for alarm, with open circuit fault.
- Normally-open contact, closing for alarm, with short and open circuit fault.
- Normally-closed contact, opening for alarm, with short circuit fault.
- Normally-closed contact, opening for alarm, with short and open circuit fault.

Use with *MX1*.

Specifications

Operating Voltage ¹	20 to 40Vdc*
Quiescent Current	300µA (max.)
Alarm Current	3mA (max, LED on)
Circuit Resistance	50 Ohm
Relay Contact Rating	2A @ 24Vdc (max.)
EOL Resistor	3k3 Ohm
Alarm Resistor	680 Ohm
Ambient Temp	-25 to +70°C
Relative Humidity	10% to 95% (n/cond)
Dimensions (HWD)	61 x 84 x 25mm
ActivFire Listed	afp-3168
FPANZ Listed	VF/671
CIE Compatibility	MX1-Au, MX1-NZ

Part Number

555.800.063

1. *MX* addressable loop voltage

SNM800 Sounder Notification Module



The SNM800 Sounder Notification Module can be used to switch an external power source to sounders, extinguishing devices or other auxiliary equipment. The output is activated in response to a command from the c.i.e. The wiring to the controlled devices can be supervised for open and short circuit fault conditions and the external power source for the devices can be optionally supervised. Each output device (sounders etc) must have a suitable diode wired in series (if not already contained in the device) so that the whole line is supervised up to the End of Line Device (27K resistor).

Use with *MX1*, MX4428, 4100ESi.

Specifications

Operating Voltage ¹	20 to 40Vdc*
Quiescent Current	450µA (max.)
Alarm Current	3mA (max, LED on)
Output Current	2A @ 30Vdc (max.)
Output ELD	27K Ohm 0.5W
External 24V Supply	18 to 28Vdc
Ambient Temp	-25 to +70°C
Relative Humidity	10% to 95% (n/cond)
Dimensions (HWD)	61 x 84 x 25mm
ActivFire Listed	afp-3169
FPANZ Listed	VF/644
Part Number	SNM800

1. *MX* addressable loop voltage

VIO800 VESDA Interface Kit



The VIO800 is an arrangement of the MIO800 Addressable Multi-I/O Module supplied ready to be fitted on to a VESDA LaserPLUS™ or Laser SCANNER. The MIO800's inputs and outputs are wired to the relay outputs and control inputs of the LaserPLUS or Laser SCANNER to allow compatible *MX* CIE to monitor and control the VESDA units. **Use with *MX1*, 4100ESi.**

Specifications

Operating Voltage ¹	20 to 40Vdc
Quiescent Current	480µA (max.)
Operated Current	3mA (max, LED on)
Relay Contact	2A @ 24Vdc (max.)
Ambient Temp	-25 to +70°C
Relative Humidity	10% to 95% (n/cond)
Dimensions PCB (HWD)	72 x 110 x 18mm
Not ActivFire Listed	
FPANZ Listed	VF/655
Part Numbers	
516.018.014K	VIO800 (Aus)
VIO800	VIO800 (NZ)

1. *MX* addressable loop voltage

MX Module Housings

A variety of ancillary housings are available to fit the MX ancillaries. The standard sized modules (CIM800/DIM800/DDM800/LIM800/LPS800/RIM800/SIO800/SMN800) are mechanically compatible with all options. The MX range of Addressable Modules can be fitted to a double gang back box or an empty responder box. The double gang back boxes are available in PC/ABS or aluminium. The responder box is galvanised mild steel and is supplied pre-drilled for up to 4 MX modules, with 16 PCB standoffs. For MX1 installations, the MX1 loop card mounting bracket (FP1027) provides mounting for 2 standard MX modules or 1 large MX module (MIO800).



K2142 Double Gang Back Box

Specifications

	K2142	M520
Dimensions	85x146x38	87x148x14
Material	PC/ABS	PC/ABS
Part No	517.035.010	517.035.007

Dimensions shown in format HWD. Units in mm.



M520 MX Module Cover incl. PCB cover and screws.



FP0529 Empty Responder Box showing 2 standard MX modules fitted. The recommended module mounting combinations are:

- 4x standard modules (CIM800/DIM800/DDM800/LIM800/LPS800/RIM800)
- or 2x large modules (MIO800)
- or 2x standard modules and 1x large module
- or 1x responder (ADR/MPR/MXP)

Hardware included:-

- 16 x HW0130 plastic PCB stand-offs
- 2 x HW0168 1" body plugs, fitted to box
- 4 x HW0310 M3 x 10 hex Nylon barrel nut
- 1 x LBO283 FP4000 Responder wiring label
- 1 x LBO296 F4000 ADR wiring label
- 1 x LBO370 F4000 MPR wiring & config. label
- 1 x LBO568 F4000 MXP wiring label
- 8 x SCO172 M3 x 6 Pan Head Phillips screws
- 1x LTO401 Instructions



517.035.011 K2214 Aluminium Back Box

Specifications

	K2214	QFB/2
Dimensions	86x146x40	85x146x38
Material	Aluminium	PC/ABS
Part No	517.035.011	517.035.015

Dimensions shown in format HWD. Units in mm.



517.035.015 QFB/2 Flush Mnt Back Box



D800 IP55 Enclosure

Specifications

Dimensions (HWD)	140 x120 x70 mm
Material	PC/ABS
Ingress Protection	IP55
Part Number	557.201.401

The D800 Ancillary Housing provides an IP55 rated enclosure for all MX modules. It incorporates a window to view the module LED.

By using the FP1062 or FP1063 mounting brackets, up to 16 x DDM800 (32 circuits) or (at a squeeze) 24x DDM800 (48 circuits) can be fitted into a 15U MX1 (with no gear plate mounted loop cards or T-GEN 50 fitted).

Specifications

Dimensions (HWD)	240x185x53 mm
Material	1.2mm Galv. Steel

Part Numbers

FP0529	Responder Box
FP1027	MX1 Loop Card Brkt
FP1062	MX1 4xModule Brkt
FP1063	MX1 4xDDM800 Brkt

DIN Rail Mounting Bracket Kit and Accessories



547.004.002 DIN Rail Mounting Bracket



DIN Rail Mounting Bracket shown with RIM800 (not included).

The DIN Rail Mounting Bracket can be used to mount standard sized MX Ancillary Modules (61 x 84mm) onto a standard 35mm DIN Rail by simply clipping the PCB onto four pre-fitted plastic pillars. The MX1 Loop Card/Module Bracket provides an alternative module mounting facility for in-cabinet MX1 installations.

Part Numbers

547.004.002	DIN Rail Bracket
FP1027	MX1 Loop Card/2x Module Bracket (not shown)
FP1062	MX1 Loop Card/4x Module Bracket (not shown)



DIN Rail Mounting Kit

Specifications

Dimensions (HWD)	78 x113 x 31 mm
Material	PC/ABS
Part Number	557.201.303



DIN Rail Mounting Kit for MIO800 (not included), shown fitted on DIN rail (not included)

MX4428 Responders

MXP Supports MX Addressable Device Technology



The MXP has two major functions:

- To provide an interface to an MX4428 responder (communications/power) loop, via which data gathered by the MXP may be transferred to the MX4428 Master for display, annunciation, and processing as appropriate.
- To provide an interface to the MX Analogue Loop. Data retrieved from the MX devices connected to the Analogue Loop is processed to determine the ALARM/NORMAL/FAULT status of each device, and this data is passed on to the MX4428 Master via the MX4428 Loop Interface. The Analogue Loop interface also allows outputs to be sent to those devices that support them, to initiate MX device tests, activate relays, etc.

The MXP is one printed circuit board (1901-213). The MX Responder supports up to 200 MX multi-sensor virtual detectors (Photoelectric and Heat, CO and Heat, Ionisation-only, Heat-only) and a range of functional bases, addressable callpoints, input modules, and output modules.

Dimensions

PA0893 240 x 180 x 50 mm (PCB only)

Part Numbers

FP0824 MXP Responder in box
 PA0893 PCB Assy 1901-213 MX4428 Responder
 LT0273 MX4428 MXP Technical/Eng Manual

ADR-M Supports 15V Manual Call Point & non-Addressable Detector range



FP0755 ADR-M, 1901-198 4mA 15V MCP

The FP0755 version of ADR supports the 15V MCP, the 614 series of detectors and all the other detectors from earlier versions of ADR, along with some new programmable circuit types.

The ADR-M and its new version software replaces the existing ADRs for standard production and can be purchased under part numbers listed. The existing ADR part numbers will still be available in low quantities for service replacements and upgrades. Please note that the new ADR-M software MUST NOT be installed in any existing 2.5mA or 4mA ADR PCBs as it will not work properly!

The PA0844 version of ADR-M is used as a retrofit where existing detector circuits use a resistor ELD in the range of 1k5 to 3k3 ohms (restrictions apply), and Intrinsically Safe applications – since the intrinsically safe Active ELDs (EOL002ZEx) are no longer available for the standard ADR-M and the replacement units (EOL002B) are not intrinsically safe approved. The module must be set for passive ELD (SW2 off). As there are no R2 resistors fitted, these do not need to be cut.



PA0844 ADR-M, 2.5mA 3k3 ELD for I.S. Detectors

Dimensions

ADR-M 240 x 180 x 50mm (all ADRs, PCB only)

Part Numbers

FP0755 ADR-M 1901-198 4mA 15V MCP in box
 FP0574 ADR 2 cct Flameguard c/w RRM
 PA0815 PCB 1901-198 ADR-M 4mA15V MCP
 PA0844 PCB 1901-200 ADR-M 2.5mA 3k3 EOL
 SF0212 Software, ADR-M V2.21 OTP
 FP0529 Empty ADR box
 FP0507-5 EOL002B Active End Of Line Pkt 5

Responder Relay Module (RRM)



PA0453 RRM PCB 1901-15

The Responder Relay Module (RRM) is an optional add-on board to an ADR. When added the responder the combination is referred to as an Advanced Relay Responder (ARR). The RRM provides four relay outputs, which may be individually configured as supervised or not. The RRM provides a current limited 24V output (100mA), which may be used to power external equipment, as long as it is wired through NO relay contacts.

The RRM must be used on ADRs with software versions V1.01 or greater, to provide RRM present monitoring.

Part Number

PA0453 PCB Assy 1901-15 RRM

Multi Protocol Responder (MPR) for Series 130 & Legacy Addressable Devices



The MPR has the following features:

- * Supports Series 130 loop & devices
- * Supports 2 wire loop/lines up to 2km in length
- * Up to 198† addressable devices per loop
- * Supports all addressable devices previously supported by the obsolete AAR:-
 - C7xA and P7xA smoke detectors
 - ADU002 • ADU003A
 - ADU004A • ADU006
 - SCI-2 Short Circuit Isolators
- * Supports Olsen Z54A Addressable Bases
- * Improved Analogue Loop fault tolerance. An open circuit on either wire, anywhere on the loop, will not affect operation of the devices on the loop. Also, open circuit of either wire produces a single event
- * Up to 32 MPRs per responder loop
- * Single PCB construction for easier maintenance

and installation

- * PCB fits into F3200 card rack for high density mounting – e.g., F4000 19" rack cabinet

The MPR is hardware and software compatible with the obsolete AAR (2 wire mode only), and can replace an AAR running in 2 wire loop (line) mode with no re-programming of the MX4428/F4000 panel.

† Up to 99 Detectors and 99 Devices

Dimensions

PA0713 240 x 180 x 50 mm (PCB only)

Part Numbers

FP0575 FP, MPR 1901-141 in box
 PA0713 PCB Assy 1901-141 MPR
 LT0139 MPR Technical Manual
 LT0140 MPR Engineering Manual
 SF0238 MPR Software V3.01

Input/Output Responder (IOR)

The IOR is a single 32 Input/32 Output responder which draws its DC operating power from, and communicates with the MX4428 Fire Indicator Panel via the 4 wire loop. Connection to the MX4428 loop is via demountable screw terminals. Field connection of inputs/outputs is provided by screw terminals on separate termination boards. These connect to the IOR by 26-way Flat Ribbon Cables (FRCs) which have to be ordered separately.

The IOR is configured by DIL switches for base address, number of equivalent ADRs, input type and number of output boards. The MX4428 Master is programmed as if the equivalent configuration of ADRs and Relay Responders (ARR) were present. The IOR inputs can be used for monitoring "clean contacts" open collectors or TTL outputs. The IOR outputs are open collector and can be used with an IOR Output Termination Board to switch LEDs, etc. Alternatively the IOR can connect directly to 16-Way Relay Boards. There is a nominal 650mA current limited 24V output to power the LEDs, relay coils, etc. Please note that current to drive these outputs is drawn off the loop, unless supplied externally.

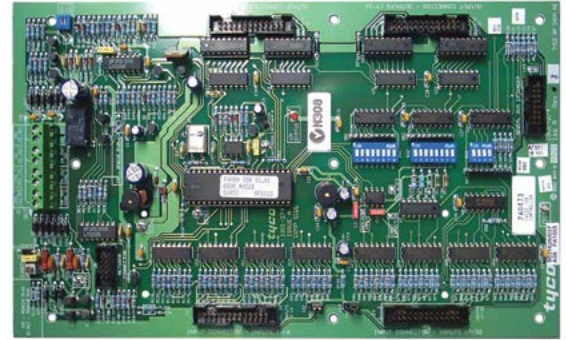

Dimensions

PA0473 270 x 180 x 50 mm (PCB only)

ME0088 449x494x82mm (cabinet only)

Part Numbers

PA0473 PCB Assy 1901-72 IOR

SF0123 Software, V2.01

ME0088 IOR Cabinet c/w 003 Lock

16-Way Relay Board (IOR)

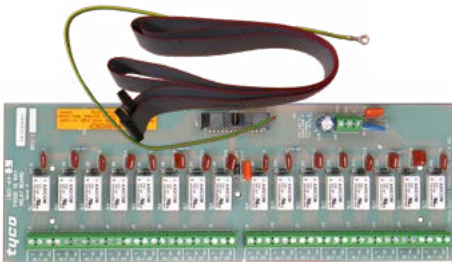

PA0470 16W Relay Board 1901-64 c/w LM0056

The 16-way Relay Boards may be connected to either or both of the Output connectors on the IOR to provide 16 or 32 clean contact relay outputs. A 1.4m 26-way FRC (LM0056) is supplied with the relay board for connection to the IOR



FRC 26W Style B for IOR
LM0044,45,46,56

These assembled 26-way FRCs are available to connect the IOR to termination boards. Cables should be selected according to the particular mounting requirements.

Input and Output Termination Boards (IOR)

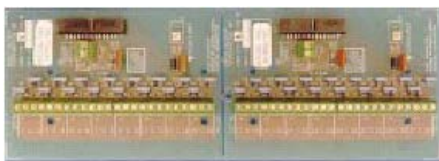

PA0474 IOR 32W Input Termination 1901-73-1

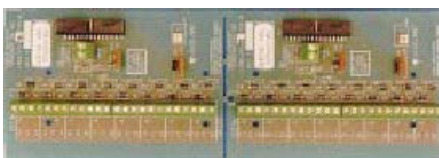

PA0475 IOR 32W Output Termination 1901-73-2

The IOR Input and Output Termination Boards allow termination of up to 1.5sq mm field wiring in screw terminals. The termination boards are connected to the IOR using 26 way FRCs (One FRC is required for each 16 circuits). The termination boards are available for 16 or 32 inputs or outputs. A 32-way termination board is the same size as a 16 way relay board and fits the same mounting hole pattern. A 16-way termination board is a 32 way board separated in half.

For more information, refer to the IO-NET section on page 29.

Part Numbers

Protected Termination Boards

PA0474 32W Input Protect. Term. Board

PA0475 32W Output Protect. Term. Board

PA0479 16W Input Termination Board

(obtain by separating PA0474 in

two)

PA0480 16W Output Termination Board

(obtain by separating PA0475 in

two)

Unprotected Termination Boards

PA0483 16W Unprotected Term.Bd, no

resist.

PA0769 16W Unprotect. Term Bd c/w resist.

Looms & Cables

LM0044 FRC, 26W Style B, 2m

LM0045 FRC, 26W Style B, 5m

LM0046 FRC, 26W Style B, 0.5m

LM0056 FRC, 26W Style B, 1.4m

MX4428/F4000 Loop Booster



The MX4428/F4000 Loop Booster overcomes problems such as Responder loop voltage drop and excessive loop length that would otherwise necessitate a restriction in responders or the use of thicker loop cable. By providing additional power supply capacity to an MX4428/F4000 loop, the Loop Booster is a practical and cost-effective means of overcoming these problems, thus enabling extension of the loop length, additional

Responders, or smaller cable size to be used. In fact, one loop Booster will allow three times the loop current, loop length, or 1/3 the cable resistance. The use of Loop Boosters in an MX4428/F4000 system completely overcomes loop voltage drop as a practical limit to system size and allows a loop to be extended until the 127 Responder limit is reached. The Loop Booster contains its own batteries and charger and when placed in the loop, provides power to a section of the loop and monitors the other. If the voltage on the monitored side falls below 17.0V then the Loop Booster supplies power to this leg as well. It checks at regular intervals to see if the normally monitored leg can self-establish a voltage of greater than 17.0V. The Loop Booster has an ADR and RRM built into it allowing fault and control signals to be conveyed to and from the FIP via the Loop communications. The Loop Booster is able to perform a local battery test and to energise the power supply for the monitored leg of the loop. It can transmit signals to the FIP (e.g. battery test fail, battery low, battery fail and/or charger fault) as well as a monitored leg voltage fail. Remote activation of the battery test and loop relay can be carried out at the FIP by using an ACZ and suitable output logic equations.

Specifications	
Power	240 VAC +6%, -10% 50Hz, 150W
Battery Requirements	As per FIP
Operating Temperature	-5°C to +45°C
Relative Humidity	10% to 90% (n/cond)
Operating Currents	
Booster Board	40 mA nominal
Indicators	8 mA per LED
Output Relay Rating	5 A (Emergency Feed)
Output Terminals	
+VNBF	27V nom, 1.6A fuse not battery backed
+VBF	27V nom, 1.6A fuse battery backed
Material Finish	1.6mm mild steel Cream Wrinkle powdercoat
Dimensions (HWD)	680x470x167mm
Weight	16 kg (no batteries)
Max. Batt. Size (HWD)	170x165x125mm (for each battery)

Part Numbers	
PA0463	PCB Loop Booster 1901-35
FPO487	Loop Booster 1901-36

IO-NET Programmable Control System

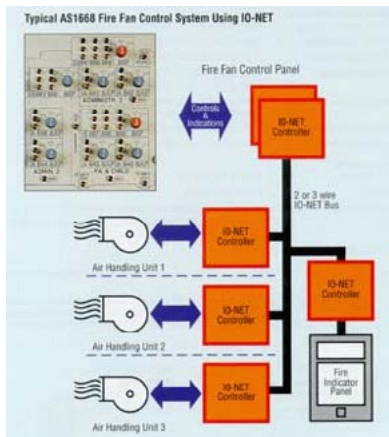

The IO-NET programmable controller is a stand-alone or networkable unit that can be used to provide similar functions to a traditional logic controller. It can also be programmed to monitor the F3200/MX4428/MX1 RZDU protocol or provide versatile AS1668 air-handling control and indication functions. Multiple IO-NET units may be connected together (2-wire bus) to provide low cost point-to-point or distributed telemetry for multiple locations. IO-NET can support at least 32 controllers on a 1mm² line up to 3km long. Modem and fibre optic options allow operation over longer distances or in "noisy" environments. This default mode of operation will only require setting up the DIP switches on the IOR, no factory or on-site programming is required.

Part Numbers	
PA0498	PCB 1901-117 IO-NET Controller
PA0474	PCB 1901-73-1 IO-NET 32W Input
PA0475	PCB 1901-73-2 IO-NET 32W Output
PA0481	PCB 1904-100 RZDU/RS232 I/F
PA0483	PCB 1901-103 IOR Unprotected Term
PA0470	PCB 1901-64 16W Relay board
PA0700	PCB 1901-120 IO-NET Programmer
PA0769	PCB 16W Unprotected Term. & resistors
SF0239	IO-NET Controller software V2.01
LM0044	FRC 26W Style B, 2m
LM0045	FRC 26W Style B, 5m
LM0046	FRC 26W Style B, 0.5m
LM0056	FRC 26W Style B, 1.4m

IO-NET Controller

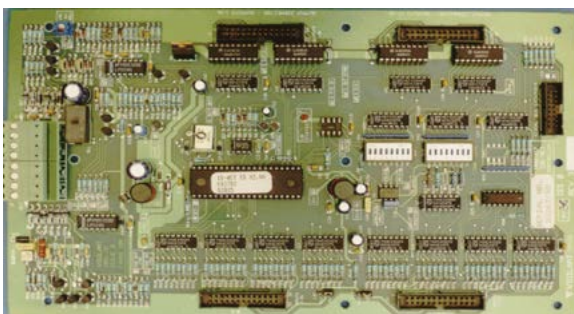

PA0498 IO-NET Controller

Each IO-NET Controller has 32 digital inputs and can provide up to 32 programmable outputs. From this starting point the system can be expanded up to a maximum of 128 Controllers on one IO-NET communications network. At least 32 Controllers can be supported on a 1mm² pair up to 3 km long.

Specifications	
Dimensions	270x165x25 mm
Weight	310g
Power Supply	24Vdc

Part Numbers	
PA0498	PCB 1901-117 IO-NET Controller
SF0239	IO-NET Controller Software V2.01 (replacement when program memory becomes full)

IO-NET Programming Unit



The IO-NET Programming Unit transfers the program to the IO-NET Controller PROMs. The Programming Unit is supplied complete with a cable to connect to a PC, the compiler programming software and the user manual. An external 24Vdc supply is required. IO-NET is also able to be programmed using SmartConfig Version 1.6 onwards. If the IO-NET site specific configuration is stored in read-only memory. It may be re-programmed multiple times before requiring replacement (SF0239).

Specifications	
Dimensions (mm)	240 x 180 x 50 (LWH)
Weight	700g
Part Numbers	
PA0700	IO-NET Programmer
SF0239	IO-Net Controller Software V2.01 (replacement when full)

IO-NET 16-Way and 32-Way Protected Termination Boards

The 16 Input and 32 Input, along with the 16 and 32 Output Protected Termination Boards are used for connecting field wiring to the IO-NET Controller. These termination boards include transient suppression components to protect the IO-NET from electrical transients. They must be used to terminate all IO-NET Controller cabling that extends beyond the IO-NET enclosure. The termination board is connected to the IOR using 26-way FRC (One FRC is required for each 16 circuits).

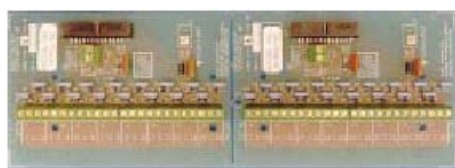

PA0474 IO-NET 32W Input - no FRC included

Specifications	
Cable Termination	1.5mm ² max.
Dimensions	
32-Way	270 x 93 x 23 mm
16-Way	135 x 93 x 23 mm
Weight	
32-Way	200g
16-Way	100g

Part Numbers	
PA0474	32W Input Protect. Bd only
PA0475	32W Output Prot. Bd only
PA0479	16W Input Term. Bd (separate PA0474 in two)
PA0480	16W Output Term. Bd (separate PA0475 in two)

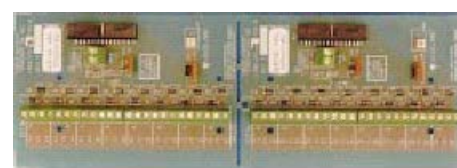

PA0475 IO-NET 32W Output - no FRC included

IO-NET 16-Way Unprotected Termination Boards



PA0483

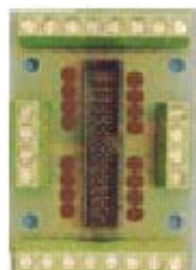

PA0769

Unprotected Termination Boards are small printed circuit boards providing direct screw terminations for 16 inputs or 16 outputs of an IO-NET Controller. No transient protection is provided so these boards should only be used where the wiring is not extended beyond the IO-NET Controller enclosure. Typical uses include connection of mimic lamps and control panel switches to an IO-NET Controller. A version of this board is available for connection to LEDs without their own current limiting. The current limiting 3k3 series resistors sets the current to approximately 7 mA from 24Vdc. High efficiency LEDs must be used.

Specifications	
Cable Termination	1.5mm ² max.
Dimensions	69 x 46 x 18 mm
Weight	100g
Part Numbers	
PA0483	16W Unprotected Term. Bd, no resistors
PA0769	16W Unprotect. Term Bd c/w resistors.

IO-NET 16-Way Relay Board



The 16-Way Relay Board has the same physical dimensions and footprint as the 32-Way Protected Termination Board. It comes complete with a 1.4 metre 26-way flat ribbon cable (LM0056) for connection to one of the IO-NET output connectors.

Specifications	
Relay Coil Current	12mA @ 24 Vdc
Relay Contacts	30V 2A resistive, 1A inductive
Contact Configuration	Single pole, changeover
Cable Termination	1.5mm ² max.
Dimensions	270 x 93 x 25 mm
Weight	350g
Part Number	
PA0470	PCB 1901-64 16W Relay board

RZDU to RS-232 Interface Board



The RZDU to RS232 Interface is a small printed circuit board that converts Remote Zone Display Unit serial communications from a fire indicator panel into RS232 compatible signals. This module is required for an IO-NET Controller to receive information from an F3200/MX4428/F4000/MX1 fire alarm panel.

Specifications	
Operating Voltage	17 to 30 Vdc
Operating Current	5mA
Dimensions	270 x 93 x 25 mm
Weight	100g
Part Number	
PA0481	PCB 1904-100 RZDU/RS232 I/F includes LM0061 FRC

RS485 Network Interface

PA0711 RS485 Comms PCB 1901-139-1 Plug-on (Modem connection to MX4428 Main Board - external power). The PA0711 can be used to interface an MX4428 FIP with the RS485 network. The board is mounted on the modem connector, located at the top of the MX4428 Main Board.



PA0712 RS232 to RS485 PCB 1901-139-2 (RS232 to RS485 - external power). It is used to convert between RS485 and RS232 level signals. Because RS485 links can be much longer than RS232, the PA0712 can be used to transmit serial data over long cables between devices which have RS232 serial ports (e.g., between the F4000 printer port and the printer). It can also be used to interface a PC with the RS485 network. Loom LM0065, a 500mm long cable with both RS232 DB9 socket and plug fitted must be ordered separately.

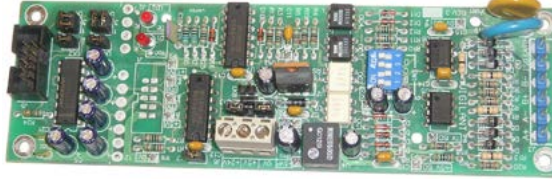

PA0773 RS485 Comms CMOS PCB 1901-139-3 FRC only (FRC connection - including power). The PA0773 is used to interface an F3200 FIP, MX4428 FIP, PTM, NLDU, MODBUS BRIDGE, RDU or NDU with the RS485 network. This RS485 Communication Board is mounted on four metal stand-offs, which are used for earthing the PCB. This RS485 board connects to the controller board via a 10 way FRC LM0172 (ordered separately), which is also used to power the RS485 Board.



Specifications

	PA0711	PA0712	PA0773
Operating Voltage			
Ext.24V	8.5 to 30Vdc	-	-
J2 5V	4.8 to 5.2Vdc	-	-
Quiescent Current			
RX only 24V	24mA	26mA	-
RX only 5V	2mA	26mA	26mA
TX act. 24V	50mA	75mA	-
TX act. 5V	25mA	75mA	75mA
Rel. Humidity	10% to 95% (n/cond)		
Ambient Temp.	-5°C to +75°C		
FPANZ Listed	VF/636		
Dims (mm)	130x50	156x50	156x50

Part Numbers

PA0711	RS485 PCB Plug-on (ext pwr)
PA0712	RS232 to RS485 (ext pwr)
PA0773	RS485 CMOS FRC only

I-HUB Intelligent Network Hub



FP0771 Ring NET Upgrade Kit



The I-HUB performs bridging and routing functions for devices on the VIGILANT Panel-Link network, supporting ring, multi-drop and point to point networks. It can assist in reducing congestion on large networks by using its filtering and 'routing' capabilities. The I-HUB has five network ports; which allow the I-HUB to be connected to a network of devices or to a single device. Messages received on one port can be routed to any or all of the other ports. Ports 1 & 2 are 2 or 4 wire RS485 or fibre, Ports 3 & 4 are RS232. Port 5 is a TTL level serial port.

I-HUB Ordering Codes

FP0770 1931-102, NDU to Ring NET upgrade kit. Includes PA0839 mounted on deeper backplate, LM0152, LM0065, mounting hardware.

FP0771 MX4428/F3200, Ring NET upgrade kit. Includes PA0839 on bracket, LM0151, LM0152, LM0065. Note an F3200 may require an IC0358 to be fitted to U13.

PA0839 PCB Assy, ECM9603 PANEL-LINK I-HUB. Includes I-HUB PCB, software, LM0065

KT0144 PMB/TPI RS485 support module kit. Includes PA0712, LM0084, mounting hardware.

PA0773 PCB 1901-139-3, RS485 bd, TTL

PA0868 PCB 1931-110, CMOS RS232 interface

PA0878 PCB 1931-118, CMOS/TTL signal splitter

LM0572 Loom1901-303, I-HUB to OSD139. Includes a zener diode, dropping resistor for PSU.

LM0065 10-way FRC connector to DB9M & DB9F (ribbon cable - supplied with I-HUB)

LM0076 DB9F to DB9F 'null modem' cable

LM0084 10 way FRC to 10 way FRC 0.35m

LM0091 10 way FRC to 10 way FRC 0.5m

LM0151 10-way FRC to Molex crossover cable, (Port 5 to MX4428 molex 'Modem' connector)

LM0152 10-way FRC to 10-way FRC special crossover cable (Port 5 to MX4428/F3200 10-way network connector)

LM0160 10 way FRC to 10 way FRC 1m

LT0229 I-HUB User's Manual

SF0202 Software, PanelLink I-HUB V1.14 EPROM



PA0868 CMOS/TTL RS232 I/F PCB

Specifications

Operating Voltage	9.6 to 28Vdc
Operating Current	140mA (9.6V) to 85mA (28V)
Ambient Temp	-5°C to +45°C
Relative Humidity	0 to 95% (non/cond)
Dimensions (mm)	265 x 95 x 25 (LWH)
Weight	0.25kg
ActivFire Listed	afp-2320
FPANZ Listed	VF/634

OSD139 Fibre Optic Modem



The OSD139HS Asynchronous RS232 Transceivers can interconnect one RS232 data channel over 3km of multimode fibre (OSD139HS) or over 40km of single mode fibre (OSD139HSL). These can provide complete end-to-end isolation of a full duplex asynchronous data transmission at up to 120kbps.

The OSD139HS are high performance fibre optic modems capable of linking asynchronous RS232 data over several kilometres at speeds ranging from DC to 120kbps. Recommended for I-HUB Ring network applications.

Specifications

Optical Wavelength	850nm nominal (HS) 1310nm nominal (HSL)
Optical Connector	ST
Ambient Temp	-20°C to +75°C
Relative Humidity	0 to 95% (non/cond)
Dimensions (mm)	15 x 44 x 80 (HWD)
Weight	200g

Part Numbers

OSD139HS	HS Multimode F/O modem
OSD139HSL	HS Single mode F/O modem
FP1032	OSD139 F/O modem x2 mounting kit

MODBUS Bridge (MBB)



The Modbus Bridge (MBB) is designed to translate data from MX4428/F3200 fire alarm panel RZDU output to a Modbus communication line. It does so by monitoring the MX4428/F3200 panel, as appropriate, and storing the information it receives in its database. The bridge is also able to send data received from the MODBUS master onto an IO-NET network, to enable the MODBUS master to control outputs on IO-NET controllers. It is available packaged in a cabinet or as a board set for incorporation into other equipment. MODBUS communications options are RS232 or RS485.

Specifications

Operating Voltage	19 to 28.5Vdc
Operating Current	25mA (RS232) 50mA (RS485)
Ambient Temp	-5°C to +45°C
Relative Humidity	0 to 95% (non/cond)
Dimensions (mm)	380 x 100 x 42(LWH) (PCB) 450 x 280 x 80 (LWH) (box)
Weight	4kg (box) 425g (PCB only)

Part Numbers

FP0706	MODBUS Bridge, RS485
SF0144	s/w, MODBUS Bridge, V1.02
SF0220	s/w, MODBUS Bridge, IO-NET I/F V2.01
LT0179	MBB User Manual

Panel-Link MODBUS Bridge (PMB)



The Panel-Link Modbus Bridge (PMB) is designed to translate data from VIGILANT fire alarm systems on a Panel-Link network to a Modbus communication line. The PMB not only monitors the Panel-Link network, but also provides a means of direct control over the fire systems. The PMB database contains data on the states

and conditions of fire panels, as well as zone and point information. A Modbus master can access this data by polling the relevant addresses of the PMB and can write to holding registers sending network variables and issuing commands to panels on the Panel-link network. The PMB also has 16 I/O ports which can be read and written to by the Modbus Master. Two of these pins can be programmed as a sounder output if a fault develops in the Modbus system, and an isolate input which can locally isolate the PMB sounder driver.

Specifications

Operating Voltage	9.6 to 28Vdc
Operating Current	135mA (9.6V) to 85mA (28V)
Ambient Temp	-5°C to +45°C
Relative Humidity	0 to 95% (non/cond)
Dimensions (mm)	265 x 95 x 25 (LWH) (PCB) 450W x 280D x 80H (box)
Weight	0.25kg (PCB) 4kg (box)
Battery Capacity	6.5Ah (box)

Part Numbers

FP0699	PMB c/w PSU in box
PA0639	PMB PCB incl. mounting hardware & FA2083
SF0165	S/ware PMB V1.24 EPROM
KT0144	Kit PMB RS485 Module
PA0790	PCB ECM9603 I/O Board
LT0202	PMB User Manual

Panel-Link Internet Protocol Bridge (PIB)

The PIB is a device for interfacing a single VIGILANT Panel-Link device on to a 10BaseT Ethernet network to allow networking with other PIBs and Panel-Link devices. IP Networking is utilised for the Internet, PC Networks and Industrial Networks. IP connection equipment for almost any type of media is readily available. The PIB is especially applicable to large and/or wide-spread sites. It is also useful where it is not possible or economic to install physical cabling. The PIB can be used to connect to an Ethernet network (dedicated, or shared) or a variety of other physical media (e.g. fibre optic) via third party switches or media convertors. A redundant ring of single-mode or multi-mode fibre can easily be configured using the switches listed. One PIB is normally used at each panel; however to connect multiple panels, an I-HUB must be used between the PIB and the panels. The PIB is self-configuring for many situations. It also has filtering and routing capabilities for larger network optimisation.



Configuration and diagnostics are performed from a standard PC web browser anywhere on the network. The PIB also provides remote cross-network access to the diagnostic port of any panel directly connected to a PIB. It is supplied complete with Ethernet, MX4428 serial port, and I-HUB/panel FRC network port looms.

For more information on IP Networking, refer to Page 38.

Specifications

Operating Voltage	15-28Vdc ¹ or 10-14Vdc ²
Operating Current	60mA (excluding LEDs)
Dimensions (mm)	192 x 120 x 30 (LWH)
ActivFire Listed	afp-2320
FPANZ Listed	afp-2320

Part Numbers

FP0986	Panel-Link Internet Protocol Bridge (PIB)
SU0319	MOXA 5 Port Ethernet Switch (2 Multi Mode Fibre)
SU0320	MOXA 5 Port Ethernet Switch (2 Single Mode Fibre)
SU0325	MOXA 5 Port Ethernet Switch EDS-405A
SU0326	MOXA 8 Port Ethernet Switch EDS-408A
LT0519	PIB User Manual
LT0536	IP Networking for Fire Application & Design Manual

1. Connected between 16VAC & 12Vdc terminals
2. Connected between Batt+ & - terminals

Network LED Display Unit (NLDU)



The VIGILANT Network LED Display Unit connects to a Panel-Link network to perform a variety of functions. A single NLDU may simultaneously perform any or all of: event printing, LED display, RZDU output, and bridge functions. Typical NLDU applications are:

- Site-wide network mimic panel (up to 528 LED sets).
- Repeat LED indications at a remote network panel.
- Event printing of selected event types from selected network panels.
- IO-NET Interface for networked panels.

Specifications

Operating Voltage 24Vdc
Operating Current 150mA (excluding LEDs)

Part Numbers

FP0695	NLDU Board Set, 1942-6 Includes PA0804, PA0703, PA0773, mounting hardware
FP0696	NLDU, Packaged, 1942-5 Incl. slimline surf mnt cab, PA0804, PA0703, PA0773, mounting hardware
PA0804	PCB 1931-84-1, Ctrlr Net/NDU,no S/W
PA0703	PCB 1931-27,F3200 Remote I/F
PA0773	PCB 1901-139-3, RS485,CMOS,FRC
SF0145	NLDU Software V2.03
LT0188	NLDU User Manual

Protocol Translation Module (PTM)



The Protocol Translation Module (PTM) provides an interface between VIGILANT fire panels on a Panel-Link network and a network event printer or an XL Graphics computer system. The PTM is programmable as to which panels/events are printed or sent to the XL Graphics system.

- Interfaces VIGILANT fire panels or Panel-Link network to network event printer or XL Graphics
- Event printer could be actual printer or event receiving system - Nurse Call, BMS, etc., that can handle text strings
- Configurable for what event types to print: Zone, System, Circuit, Point, Relay, System Operating
- Programmable group membership
- Individual fire panels can be selected for logging events/passing to XL Graphics

- Selectable fire panel monitoring - failure events generated if no messages received from each panel
- Programmable Panel-Link network operation - including ACK broadcasts
- Non-volatile storage of programmed parameters
- Supplied in painted metal cabinet
- 12V or 24Vdc operation
- RS232 interface to printer/XL Graphics

Specifications

Operating Voltage 24Vdc
Operating Current 19mA (excluding LEDs)
Dimensions (mm) 450W x 280D x 80H (box)
FPANZ Listed VF/616

Part Numbers

FP0586	Protocol Translation Module (PTM in box)
PA0799	Protocol Translation Module PCB only

I-HUB Ring Networking

The I-HUB is a part of the family of products that connect to the VIGILANT Panel-Link network. The I-HUB performs bridging and routing functions for the Panel-Link network. The I-HUB supports ring, multi-drop and point-to-point networks. Deploying an I-HUB in a ring can add extra levels of redundancy and service protection otherwise not possible in conventional Panel-Link networks.

The I-HUB can be used in a number of different applications. The following diagrams illustrate some of the possible I-HUB uses. Please note that these

are a small overview of what can be achieved using the I-HUB and do not represent detailed implementations. Duplicated channel operation is a standard feature of the Panel-Link Network and in certain conditions is a requirement to meet fire installation standards. Refer to the appropriate standard, AS1670.1 for Australia, NZS4512 for New Zealand.

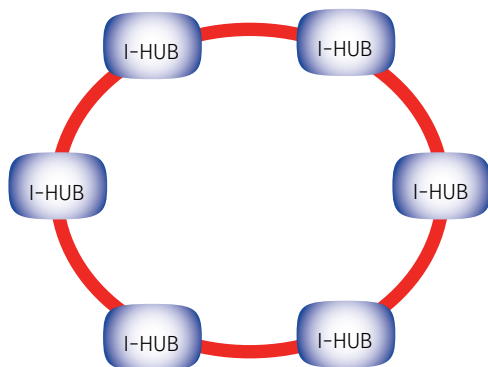

Fig 1 Network Ring example

The "RING" method shown in Figure 1 provides a level of redundancy not found in other kinds of network topology. The 'ring' configuration, with an I-HUB incorporated in each panel, is one way of providing the two separate paths required by AS1670.1 section 2.6.1 (c) and NZS4512:2003 402.2 (o).

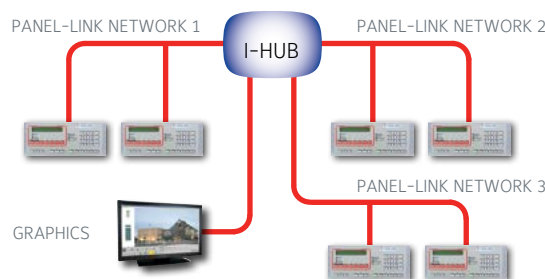

Fig 2 Joining Multiple Networks

The I-HUB can be used to connect two to four Panel-link networks together to allow a greater physical length as shown in Figure 2.

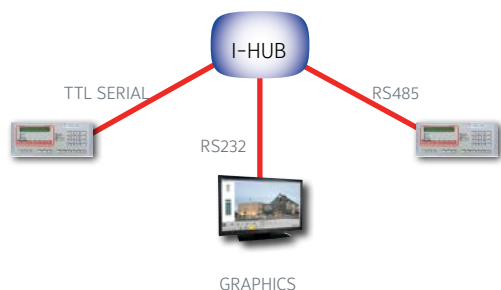

Fig 3 Networking Different Media

The I-HUB can be used to interconnect two or more networks that use different media or signalling speeds.

With large systems, care must be taken to minimise the number of messages that are passed through an I-HUB so as to avoid overloading any part of the network. For slow data links such as one using 1200 baud modems, the absolute minimum number of messages should be passed across it.

With the exception of RING mode, network designs that result in more than one path to any one device must be avoided.

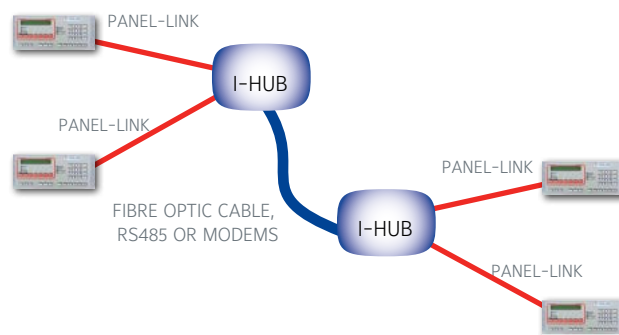

Fig 4 Joining Two Networks Together

Two I-HUBs can be used to connect two distant Panel-link networks together using fibre optic cables, modems or a customer supplied network (WAN).

Part Numbers

FP0770	NDU to Ring Network Upgrade Kit
FP0771	F3200/MX4428 Ring Network Upgrade Kit
PA0839	PCB ECM9603 Panel-Link I-HUB
KT0144	Kit PMB/TPI RS485 Support Module
PA0773	PCB RS485 TTL
PA0868	PCB CMOS RS232 Interface
PA0878	PCB CMOS/TTL Signal Splitter
PA0880	PCB DB25 to 10-way FRC Adaptor
LM0572	LOOM, I-HUB to OSD139 Fibre Optic Modem
LM0076	ECM Programming Cable, DB9F - DB9F Null Modem
OSD139HS	HS Multimode Fibre Optic Modem
OSD139HSL	HS Single mode Fibre Optic Modem
FP1032	OSD139 Fibre Optic Modem x2 Mounting Kit

VIGILANT IP Networking

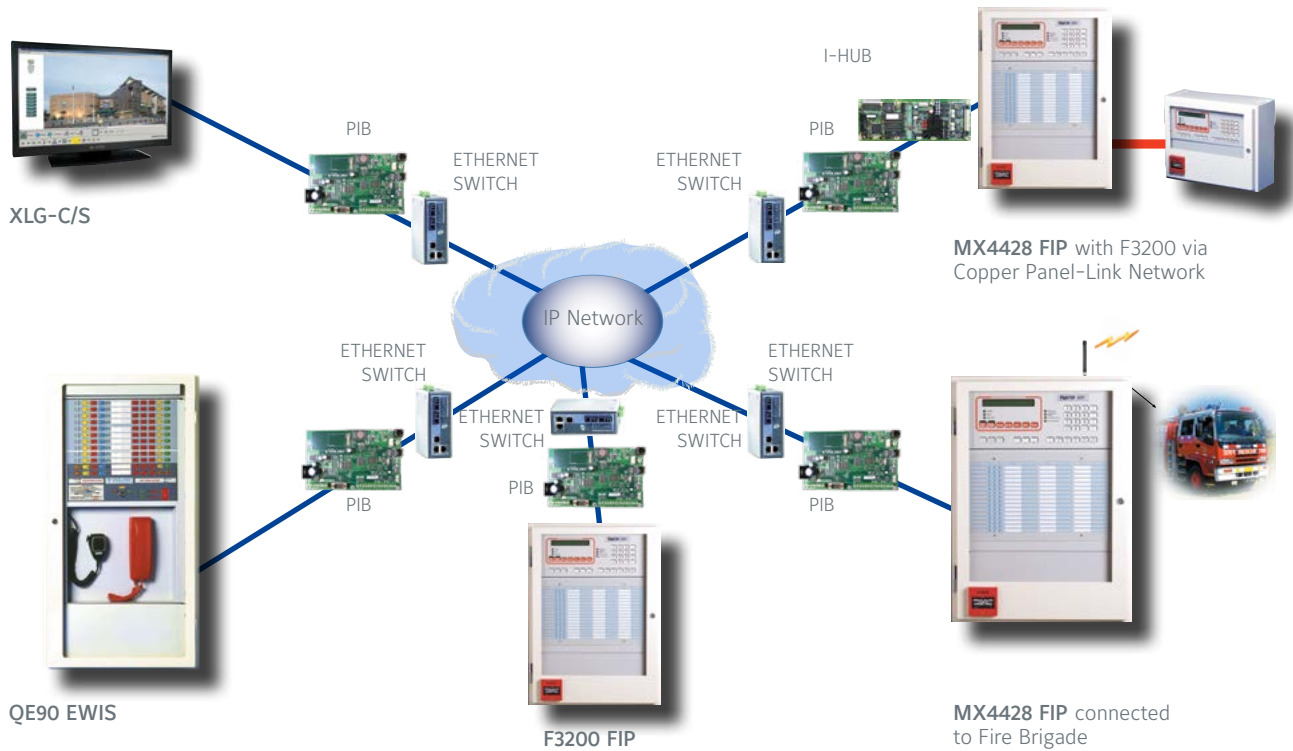

VIGILANT IP (Internet Protocol) Networking opens up a world of previously unimaginable possibilities, particularly for large, remote, and difficult sites. It is now both possible and easy for fire systems to be networked across large distances (such as within, or even between, cities) and / or to network on a large site using a customer's own network without installing new dedicated cables.

IP networking is often the most cost-effective method of networking between panels, and/or providing remote diagnostics and programming for many panels from a single point on the site, or even from off-site. This applies particularly when long distances are involved, or where special media must be used (i.e., media other than copper wire).

IP networking can use an existing customer's network (where standards compliance is not required for the networking), or alternatively a dedicated potentially standards-compliant IP network can be installed for the fire system. Note: – as yet the IP networking equipment described in this guide is not listed.

If a connection to the internet can be provided, remote diagnostic access could be obtained from virtually anywhere in the world.

The VIGILANT IP solution uses a PIB (Panel-Link IP Bridge) to connect between a VIGILANT Panel-Link device and the IP network. Additional Ethernet switches and Ethernet Extenders allow operation over fibre optic cable or long cable distances.

Features	Benefits
Uses an industry-standard interface (Ethernet) and standard protocols	Supports a wide variety of third party interfaces
Can use a wide variety of physical media	Provides a cost-effective solution for short and long distance communication, i.e., Can use fibre-optics to eliminate susceptibility to EMC (electrical interference) Can use wireless transmission systems where physical access is difficult
Provides remote access to panel diagnostics and programming, as well as providing networking	Diagnostics and programming of a whole network can be done from a single point on site, or potentially from off site
Web access is provided via panel serial port	Uses standard web browser for remote diagnostics. No special software (such as a terminal emulator) needs to be installed. This is particularly useful when using a customer's network
Many 'channels' can be multiplexed over the same cable	The same network can be used for a Fire and EWIS network, Colour Graphics client / server network, etc.
IP networking can be used for subsections of a Panel-Link network	Existing installations can be upgraded to IP networking in stages, or can use mixed systems
The interface is specially designed for Panel-Link and VIGILANT products	Avoids a large number of compromises that result if an IP interface was used

XLG - Client/Server (XLG-C/S) Colour Graphics



Using a combination of symbols, floor plans, pictures and text, XLG-Client/Server (XLG-C/S) can display the precise location of a fire alarm event and give detailed emergency response instructions. Communications can be established with floor wardens via EWIS WIP phones to co-ordinate evacuation procedures. A detailed map of the affected area can be printed automatically for use by emergency response personnel. Prompt response to a fire emergency, with the correct action, provides the opportunity to greatly improve safety and reduce financial loss. Multiple XLG Client terminals can be connected on the same network for redundancy or ease of operation. Individual user access levels allow maintenance/engineer's functions for performing higher level network investigations and configuration changes, as well as limited lower-level operator functions. XLG-C/S is able to announce and control both Fire and EWIS/Occupant Warning systems.

XLG-C/S Operation

When the status of a device on the network changes, the screen displays the type and location of the event. The operator can then navigate to a more detailed view of the zone or device.

From the XLG-C/S screen (with the appropriate password access) the operator has the ability to:

- acknowledge alarms
- silence sounders and turn off visual indicators
- perform a system reset.

Route arrows showing the recommended access path for the fire brigade can be displayed on alarm events screens. Custom alarm and fault messages can be added to provide operator dispatch assistance. Location-specific information, such as hazardous material storage and lists of people to notify, can be automatically or selectively displayed.

XLG-C/S Features

- Monitors all events on Fire and EWIS networks using graphics and text
- Automated graphic display and printing of latest fire event locations
- Simple and effective graphic interface
 - Custom alarm and fault messages guide an operator through dispatch response
- Extensive history logging
 - Full and extensive event log of the entire fire and evacuation graphics system
 - Rapid event filtering for easy event location
 - Printing of event log, graphics screens and fire system reports
- Multiple XLG terminals on a network can perform redundant operation or specific functions
- Easy site configuration
 - Point-and-click device positioning and configuration
- Supports common graphics file formats
 - Importing of CAD drawing files, metafiles, image files and scanned media
- Centralised security and service administration
 - Multiple operator levels with password control
- One-off configuration for all terminals
- VIGILANT Panel-Link network support
 - Enables monitoring and control of fire alarm and evacuation/occupant warning networks
 - Integrates numerous Fire Indicator Panels (FIPs); Conventional and Analogue Addressable
 - F3200 and MX1 via IP Networking (requires VIGILANT PIB)
- Supports a variety of Fire Detection systems
 - VIGILANT MX1, MX4248, F3200, QE90
 - SIMPLEX 4100 range
 - MINERVA MX
- Graphical diagnostic tools identify status of fire network nodes
 - PC environment monitor

XLG-C/S Screens

Graphics screens can provide easily recognisable site plan and floor plan information. The level of detail can be customised for the specific facility to easily and accurately direct the operator to the immediate area of interest. Optional icons can be added to identify the exact device of interest, and may be used to directly navigate to other predetermined screens for more detail. In addition to screen text or graphical information, the operator can be presented with specific messages that provide emergency response information and directions. These messages can be easily edited to suit local requirements.



XLG Client Screens

Fire Detection Product Catalogue



XLG-C/S Operation

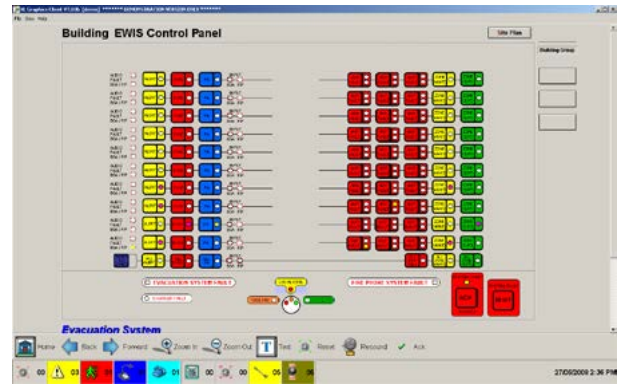

XLG-C/S Virtual ECP Screen

Multiple Network Integration

XLG-C/S supports extensive fire network integration and interconnection. Multiple networks as well as conventional FIPs can be monitored and controlled by XLG-C/S.

Each fire network and/or standalone FIP connected to the Panel-Link network interfaces to the XLG Server using a suitable communications device such as the Protocol Translation Module (PTM), Intelligent-Hub (I-HUB) or Panel-Link IP Bridge (PIB) depending on the network configuration.

EWIS networks interface to the XLG Server using a SECP/VDU Interface.

Each XLG Client terminal communicates with the XLG Server using IP networking.

XLG-C/S Operation on Panel-Link Network

- VIGILANT Panel-Link Network
 - Multidropped RS485 connections or IP via various media
 - Up to 64 networked devices multidropped depending on required functionality
 - Multidropped cable length <1200m, shielded twisted pair
 - Galvanic isolation between panels & network
 - High noise immunity
 - Reduced earth loop problems
 - I-HUBs used to extend copper network (ring configuration)
 - Link Integrity function supervises XLG-C/S network

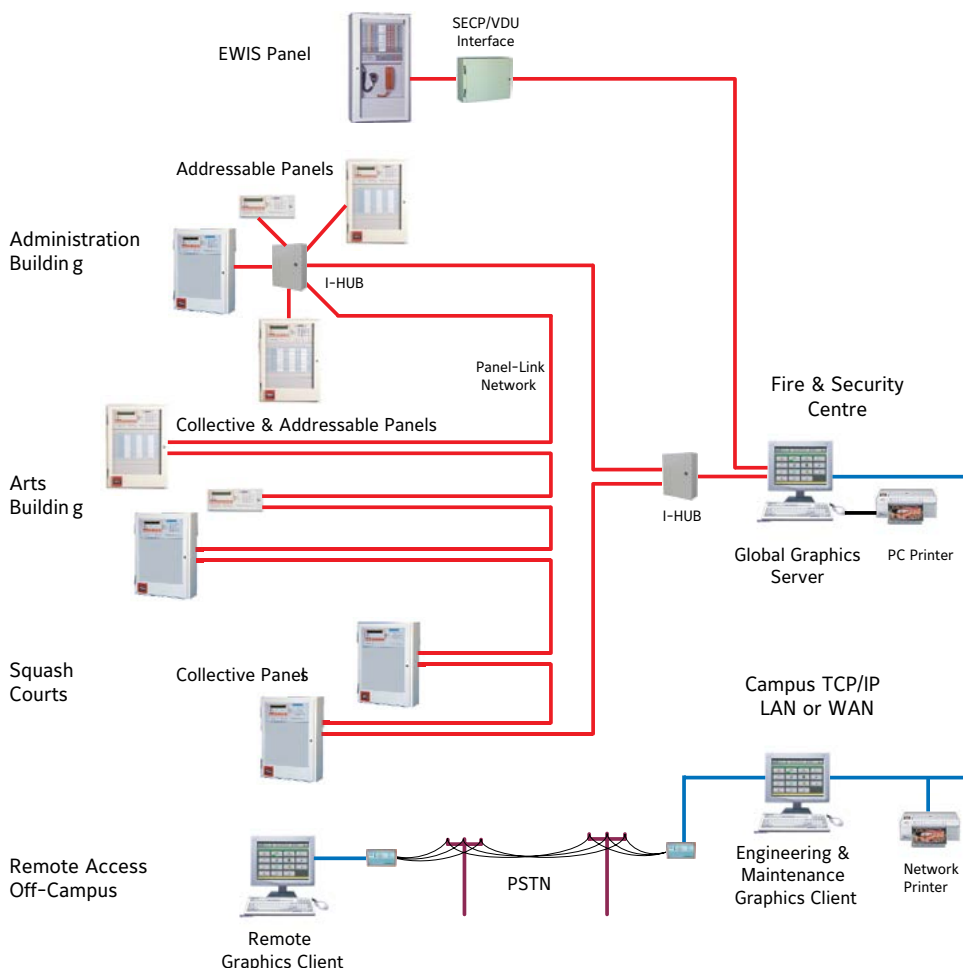

Hardware Requirements:

1. Fire panels on the Panel-Link network connect to the XLG Server using the PTM, I-HUB or PIB interface. EWIS panels are connected using the SECP/VDU Interface. The XLG Server requires a serial comm's port for each interface.
2. The XLG Server must have a free USB port.

Software Requirements:

1. WINDOWS7 32-bit or 64-bit Operating System

Part Numbers

CG0002-CS	XLG-C/S Client/Server Software & Dongle
CG0002-CLIENT	XLG-C/S Client only Software
FP0586	PTM Protocol Translation Module in box
FP0697	SCP/VDU Interface

See also pages 34 (I-HUB Networking) and 35 IP Networking).

Analogue Addressable 130 Series Detectors

The 130 series are a range of low-profile Analogue Addressable fire detectors. These unobtrusively-styled detectors have a number of unique design features to improve their operation, installation and ease of servicing. Using the VIGILANT MX4428 CIE, up to 99 detectors and 99 modules can be supported per MPR, on an analogue addressable loop length up to 2000 metres. The advanced SmartSense Algorithm used by the MX4428 significantly reduces response to non-fire phenomena. The detector address is set by rotary decade switches on the back of the detector. Two indicating LEDs can be programmed via the FIP to blink as the detector is polled and show constant red when in alarm.

C131A-Mk2 Ion Smoke Detector



The C131A-Mk2 dual-chamber ionisation smoke detector contains a state-of-the-art sensing chamber and analogue communication electronics. Used in conjunction with the VIGILANT MX4428 panel, the C131A-Mk2 has a high degree of false alarm immunity thanks to the advanced SmartSense algorithms. The detector mounts on the B501AUS or B200SR base and is designed to provide open area protection. Two LEDs on each detector illuminate during alarm to provide 360° alarm indication. An optional remote LED can also be fitted.

Specifications

Operating Voltage	15 to 32Vdc
Quiescent Current (max.)	300µA
Alarm Current (max.)	6.5mA
External Output Drive (max.)	5mA
Relative Humidity	10% to 93% (n/cond)
Ambient Temperature	-10°C to +49°C
Dimensions	102 dia. x 51H mm
Weight	160g
Remote Indicator	E500 Mk2 Series
ActivFire Listed	afp-2486
FPANZ Listed	VF/301
Part Number	C131A-Mk2

P131A-Mk2 Photoelectric Smoke Detector



The P131A-Mk2 photoelectric smoke detector contains a state-of-the-art sensing chamber and analogue communication electronics. Used in conjunction with the VIGILANT MX4428 panel, the P131A-Mk2 has a high degree of false alarm immunity thanks to the advanced SmartSense algorithms.

The detector mounts on the B501AUS or B200SR base and is designed to provide open area protection. Two LEDs on each detector illuminate during alarm to provide 360° alarm indication. An optional remote LED can also be fitted.

Specifications

Operating Voltage	15 to 32Vdc
Quiescent Current (max.)	360µA
Alarm Current (max.)	6.5mA
External Output Drive (max.)	5mA
Relative Humidity	10% to 93% (n/cond)
Ambient Temperature	-10°C to +49°C
Dimensions	102 dia. x 51H mm
Weight	170g
Remote Indicator	E500 Mk2 Series
ActivFire Listed	afp-2487
FPANZ Listed	VF/302
Part Number	P131A-Mk2

T131A-Mk2 Heat Detector



The T131A-Mk2 heat detector is a state-of-the-art dual thermistor heat detector with analogue communication electronics. Used in conjunction with the VIGILANT MX4428 panel, the T131A-Mk2 has a high degree of false alarm immunity thanks to the advanced SmartSense algorithms. It is panel programmable to either Type A (with Rate Of Rise) or Type B (fixed temperature only) to maximise system design flexibility.

The detector mounts on the B501AUS or B200SR base and is designed to provide open area protection. Two LEDs on each detector illuminate during alarm to provide 360° alarm indication. An optional remote LED can also be fitted.

Specifications

Operating Voltage	15 to 32Vdc
Quiescent Current (max.)	300µA
Alarm Current (max.)	6.5mA
External Output Drive (max.)	5mA
Relative Humidity	10% to 93% (n/cond)
Ambient Temperature	-20°C to +45°C
Dimensions	102 dia. x 51H mm
Weight	140g
Remote Indicator	E500 Mk2 Series
ActivFire Listed	afp-2488
FPANZ Listed	VF/205
Part Number	T131A-Mk2

B200SR Sounder Base



The B200SR is a direct replacement for the Z132A Sounder Base and provides mounting facilities and an inbuilt audible alarm for the 130 Series detectors. The sounder actuates whenever its associated detector enters an alarm state, providing a 90dB signal at a distance of 3 metres. To ensure that the sounder operation does not interfere with normal detector operation, the B200SR requires a separate 24Vdc supply that is electrically and physically separated from the detector supply. For supervision of the 24V line, an ADM131 Monitor Module and 24V relay may be used. For activation of a group of sounders from any one group of detectors, an ADC130 Control Module and 24V relay is used.

Specifications

Sounder Supply Voltage	17 to 32Vdc
Sounder On Current	35mA
Sounder Off Current	1mA
Loop Current (quiescent)	0µA
Loop Current (alarm)	700µA
Quiescent Current (max.)	250µA
Sounder Output	>85dBA at 3m
Relative Humidity	10% to 93% (n/cond)
Ambient Temperature	0°C to +49°C
Dimensions (Dia x H)	175 x 51 mm
Weight	227g
ActivFire Listed with 130 series detectors	
FPANZ Listed	VF/413
Part Number	B200SR

130 Series Detector Bases



The **B501AUS** is a direct replacement for the Z131A Detector Base, and should be mounted on a flat surface with suitable fasteners. A tamper-resist feature is incorporated in the base which, when used, prevents removal of the detector without using a small screwdriver or similar tool.

Specifications

Sounder Supply Voltage	17 to 32Vdc
Relative Humidity	10% to 95% (n/cond)
Ambient Temperature	-5°C to +45°C
Weight	187g
ActivFire Listed with 130 series detectors	
FPANZ Listed with 130 series detectors	
Part Numbers	
B501AUS	Analogue Detector Base

D51Z131 Duct Sampling Unit



The D51Z131 Duct Sampling Unit consists of a D51B duct housing fitted with a B501AUS base in readiness for fitting an analogue addressable P131 photoelectric smoke detector. The D51B is designed to sample air in air conditioning ducts and pass the air through the smoke detector. The housing is fixed on the outside of the duct to be sampled, allowing easy access for detector servicing and replacement of the dust filter. To cater for most duct sizes, a sampling tube extension is available in 3 metre lengths. VIGILANT E500 Mk2 Series Remote Indicators can be used for remote indication of an alarm.

Specifications

Duct Pressure*	-1.15 to +3.0 kPa
Sampling Tube Length	160mm minimum
Max. Duct Width	1.8m
Dimensions	
Base & Cover (LWH)	278x190x113 mm
Sampling Tube Pitch	122mm
Duct Holes Required	24mm dia. x 2 places
Remote Indicator	E500 Mk2 Series
Not ActivFire Listed	
Part Numbers	
D51Z131	B501AUS Base fitted
D51COVER	D51 Cover only c/w screws
D51L	Baffle box of 10
D51F	Filter box of 10
D51T3	3m Sampling Tube
D51K100	Sampling Tube End Cap (packet of 10)

*AS 1603.13-1998 test

Analogue Addressable 130 Series Modules

ADS130-Mk2 Short Circuit Isolator



The ADS130-Mk2 Short Circuit Isolator protects MPR analogue addressable loops against short circuits. When a loop short circuit occurs between ADS130-Mk2 isolators, they disconnect the section of the cable containing the short, allowing the rest of the loop to continue to function. ADS130-Mk2 isolators are usually placed between zones so that a short circuit will affect only one zone and any loss of detection capability will be minimised. The ADS130-Mk2 isolators automatically connect the loop at power-up and after removal of a short circuit. An inbuilt yellow LED provides a visual indication of isolator status.

Specifications	
Operating Voltage	15 to 32Vdc
Quiescent Current (max.)	450µA @ 24Vdc
Supply Current (shorted o/p)	17mA
ADS130s per MPR	15 max.
Max. no. Devices betw'n ADS	25
Humidity	10% to 95% (n/cond)
Ambient Temperature	-5°C to +50°C
Dimensions	120x108x34mm
Weight	140g
ActivFire Listed	afp-1446
FPANZ Listed	SS/605
Part Number	ADS130-Mk2

ADCx130-Mk2 Output Control Module



The ADCS130-Mk2 Supervised Relay Control Module provides a single switched supervised output on the MPR addressable loop. It supervises the output wiring for open or short circuit faults when the output is de-energised. The ADCS130-Mk2 can directly replace an ADC130 configured for supervised output operation (tabs in place). ADCS130-Mk2 requires a 24V supply.

The ADCU130-Mk2 Unsupervised Relay Control Module provides two change-over relay outputs on the MPR addressable loop that operate together under control of the MX4428. The two relay outputs are electrically isolated and there is no supervision of the output wiring. The ADCU130-Mk2 can directly replace an ADC130 that has been used in unsupervised output mode (tabs broken).

Either module mounts to a double gang back box with a minimum depth of 50mm.

Specifications	
Operating Voltage	15 to 32Vdc
Quiescent Current (max.)	350µA
Supply Current (max.)	6mA
Relay Contact Rating (max.)	
Resistive	2A 30Vdc
Inductive	1A 30Vdc
100V Audio Line	30 watts
Supervised Line Length	100m
Cable Size	1 to 4 mm ²
Relative Humidity	10% to 95% (n/cond)
Ambient Temperature	0°C to +49°C
Dimensions	120x108x34mm
Weight	140g
ActivFire Listed	afp-1446
FPANZ Listed	SS/604
Part Numbers	ADCS130-Mk2 (Supervised) ADCU130-Mk2 (Unsuprvsd)

ADM130-Mk2 Monitor Module



The ADM130-Mk2 is an addressable input module that allows the connection of hard contact detection devices. The module's two wire input is supervised for faults. An LED indicator allows visual monitoring of the module's status. An output is provided for connection to a remote LED indicator. Suitable remote indicators allow visual indication of the module's alarm status.

Specifications	
Operating Voltage	15 to 32Vdc
Quiescent Current (max.)	350µA
Alarm Current (max.)	5mA
Supervised Line Length	100m max.
Input Voltage (max.)	11V
Relative Humidity	10% to 93% (n/cond)
Ambient Temperature	0°C to +49°C
Dimensions	120x108x34mm
Weight	130g
ActivFire Listed	afp-1446
FPANZ Listed	SS/601
Part Number	ADM130-Mk2

Note that part number RACO232 is a suitable metal housing for ADC/ADM/ADS130 Modules

ADM131-Mk2 Mini Monitor Module



The ADM131-Mk2 is an addressable input module that allows the connection of hard contact detection devices.

The module's two wire zone input is supervised for open circuit faults. The ADM131-Mk2 is easily addressed using two robust rotary switches. Note there is no Remote LED output facility on the ADM131-Mk2.

Specifications

Operating Voltage	15 to 32Vdc
Quiescent Current (max.)	350µA
Supervised Line Length	100m max. (40 Ohm)
Lead Length	150mm
Relative Humidity	10% to 93% (n/cond)
Ambient Temperature	0°C to +49°C
Dimensions	33x70x17mm
Weight	35g
ActivFire Listed	afp-1446
FPANZ Listed	SS/602
Part Number	ADM131-Mk2

SMB-500 Surface Mount Box



The SMB-500 provides mounting facilities for ADC/ADM/ADS130-Mk2 devices. The SMB-500 has mounting facilities for one of the above the modules and cover plate. The box may be secured to a wall with screws and plastic anchors (provided) or to a junction box (screws not provided).

Assemble the module to the surface mount box with the short screws provided. Fasten the cover plate to the module, using the screws provided with the module.

Part Number

SMB-500	Series 130 Module Surface Mounting Box
---------	--

SIMPLEX 4100ESi System Overview



Over a Century of Leadership in Fire Protection

Long term infrastructure assets, like shopping centres, hospitals, road tunnels, educational institutions and industrial facilities, need protection systems that can be easily updated. It's important to maintain compliance with changing standards and community expectations without having to replace entire systems due to obsolescence.

Products Designed for Life

Simplex's philosophy of backward and forward compatibility ensures that the products available today will be compatible with more advanced products yet to come. And today's products are compatible with Simplex products installed years ago. This philosophy lowers overall life cycle costs and means that Simplex systems can always be easily expanded and converted with the latest technology or to comply with changes in the Australian Standards.

The Simplex 4100ESi incorporates a high specification, technologically advanced and unique touchscreen. Managing fire safety is simpler than it's ever been. From a single screen, and at the touch of your fingers, you can:

- View and monitor all fault points, supervisory points and Pri2 alarms
- Disable and enable points and zones
- Conduct alarm tests on points and zones
- Access level changes
- View and upload previous alarm and fault logs
- Print and upload reports
- Inspect – and respond to – service diagnostics

Once you've easily programmed the panel on a PC, everything is accessible from the panel itself – where and when you need it.

The Simplex 4100ESi is not only compatible with its existing TrueAlarm detectors, but is also the ideal match for two-way infrared-enabled MX fire detectors.

Together, the Simplex 4100ESi and MX detectors provide:

- More addressable loop powered devices – including sounders
- Even greater immunity to nuisance alarms
- Isolators in every detector head
- Improved system redundancy
- Reduced installation time – no need for an isolator every 40 devices
- Ability to use modern commissioning tools – including the 850EMT infrared tool
- Compliance to the latest AS 7240 standards

Non-Proprietary

Simplex is a Non-Proprietary product, so our systems can be serviced, installed and programmed by any company that has completed our training course. This gives you great flexibility when choosing your service provider. Simplex only allows trained and licensed companies to access our programs, ensuring only qualified personnel are modifying these important life safety systems.

Training courses are run several times a year in each state of Australia.

The new Simplex 4100ESi is here.

4100ESi Analogue Addressable Fire Indicator Panel



At a Glance

- **Fully compliant to the latest standards**
User-friendly AS7240.2-certified panel conforms to the latest Australian Standards to offer you peace of mind
- **Better capacity, greater connectivity**
2,000-point addressable device capacity – ideal for facilities of any size
Connect up to 99 panels on a single network ring – up to 3,500 metres apart in copper, or a stunning 25,000 metres apart in single mode fibre
Generous 10A power supply – Reduces the need for extra power supplies or battery boxes

- **Intuitive and Intelligent**
Easy to read and navigate interactive 26cm touch-screen InfoAlarm+ display
Regularly updated e-manuals, accessible on any internet-connected device
- **Easier installation and upgrades**
The backward compatible Simplex 4100ESi uses intuitive Windows-style programming software
Programming templates for common functions (including 1668 controls, day/night sensing, alarm acknowledgement, delay and investigation)
- **Enjoy total flexibility**
Non-proprietary – Your freedom of choice to select any trained Service Company to service Simplex fire detection products
Available off the shelf with expansion box options and a further three sizes on demand

The 4100ESi is manufactured on a build-to order basis in custom configurations to match the specific needs of each site. It is also available ex-stock in 4100ES-S1 single loop (expandable) configuration. The 4100ESi, like all 4100 systems, includes many backwards-compatibility features to minimise the risk of obsolescence. This includes full compatibility with existing SIMPLEX 4120 networks.

The SIMPLEX 4100ESi is an analogue addressable fire alarm system that provides extensive and powerful features to satisfy a wide variety of applications and site requirements. On-site programmability allows mapping logic for inputs and outputs, custom labelling, and later revisions. Detector and control point expansion is available up to 2000 points. For quantities exceeding this, multiple panels can be networked together to form a 4120 network system.

ActivFire Listed
 afp-395 (4100)
 afp-1165 (4100/4120)
 afp-1682 (4100ES/4100U)
 afp-3027 (4100ESi)

For a comprehensive list of spares – Refer to Page 125

4100ESi Analogue Addressable Fire Indicator Panel



The SIMPLEX 4100ESi is a cost competitive, out-of-the-box analogue addressable system that is based on the established power and flexibility of the SIMPLEX 4100 series of products.

Features

- Easy expansion with up to 2 MX addressable loops, programmable on-site with 250 devices per loop
- Wide range of addressable devices – detectors, sounder bases, input/output modules
- Supports on-site upload & download of panel program
- Optional AS 1668 4 way rotary or pushbutton networkable Fan Control modules
- 9A System Power Supply (SPS) module includes built-in IDNet addressable loop driver and 80Ah battery charger. Battery capacity 40Ah in standard cabinet
- Supports remote serial LCD annunciators
- Networkable into large systems using optional RS485 or fibre optic network media cards
- Optional RS232 interfaces for High Level Interface for BMS, VESDA, QE90, BACnet and PC annunciators and remote printers
- Four operator access levels
- 1200 event historical log (separate alarm/fault logs)
- Walk test and individual point disconnect/disable
- Programmable alarm verification, output logic control, alarm thresholds, network operation and annunciation
- SafelINC Internet Interface Card available for remote access via client LAN
- 19" rack cabinet 1050H x 575W x 350D mm (packaged 1130H x 630W x 350D mm, 30kg)
- Part Number 4100-FP1045

The entry level SIMPLEX 4100ESi is supplied configured as a single loop analogue addressable fire alarm system providing a low cost solution for smaller sites requiring addressable fire alarm technology.

For typical applications such as nursing homes, offices, factories and small shopping centres, the 250 device capacity is ideally sized. Where additional capacity is required, the SIMPLEX 4100ES-S1 can be expanded to cater for medium sized installations, such as a university campus or an industrial site.



4100ESi Operator Interface

Configurable

The Simplex 4100ESi is a panel fully compliant to AS7240.2. The 4100ESi is an analogue addressable fire alarm system that has a class leading large colour touch screen display compliant to AS4428.3 2010 which can control up to 500 zones. When configured as a network display unit (NDU) it can control up to 1000 zones. The 4100ESi will be available off the shelf as a 15U compact panel, with 8U expansion boxes for small to medium sized projects, or as a build to order (BTO) panel for larger projects.

The 4100ESi uses MX detector technology incorporating an isolator in each detector head. Up to 30 Addressable loops (max 2000 points) can be run from one panel, each loop can drive 250 points plus sub-points and will support a range of loop powered devices including sounders. The 4100ESi can be configured as a standalone panel, network node or data gathering panel (DGP) and can distribute its hardware such as the MX loop using low cost transponders.

4100ESi Typical System Diagram

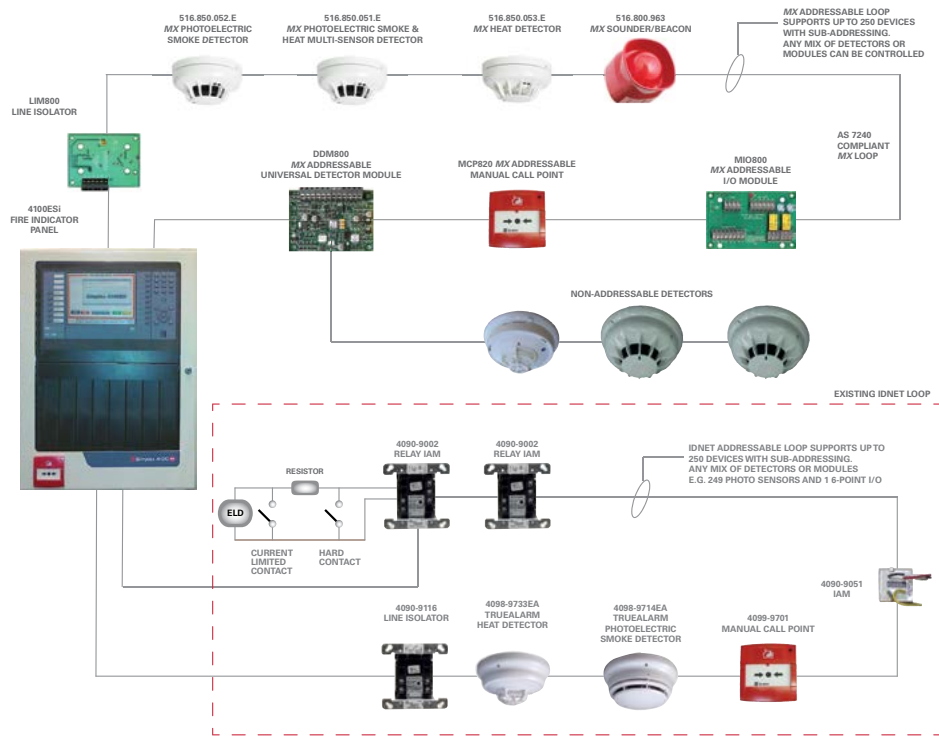

FP0937 4100ES-S1 WA/Cube ASE Door Kit

FP0937 comprises:

- 1x 4U hinged door & spacer bracket, connector strip, label, & wiring fitted
- 4x M6 screws/washers/cage nuts for mounting door
- 5x Cable ties, adhesive cable tie holders for fixing wiring
- 1x Green earth lead + nut, washer for door earth
- 4x PK screws, plastic spacers for mounting Cube ASE
- 4x M4 screws/washers for mounting the WA ASE.

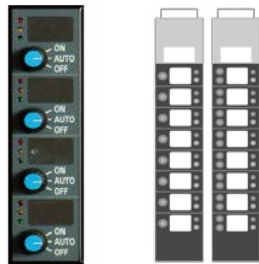

4100ESi 1668 Control Options

The 4100ESi can be equipped with 2 types of fan controls – non networkable rotary type controls or networkable pushbutton style controls. Each 4100ESi CPU is capable of managing up to 300 fans.

Non networkable 1668 controls:

4100-ME0456 4 way rotary switch controls with ON AUTO OFF labels. Optional FIRE AUTO NON-FIRE labels for damper controls. Customizable fan identification labels. ON LED also flashes to indicate alarm conditions.

Networked 1668 fan controls:

The 4100-1287AU fan module is an Ideal solution to provide duplicate controls or redundancy during emergency situations.

Each module can manage 4 x 1668 controls and indications and contains:

- Manual start, manual stop and auto push buttons & corresponding Red LEDs to show manual activation
- Red LED for the fan running status
- Red LED for duct smoke alarm
- Yellow LED for the fault status
- Green LED for the fan stopped state
- Customisable slide-in labelling for each of the pushbuttons and LEDs



FP0935 4100ES-S1 ASE Door Kit

FP0935 comprises:

- 1x 4U hinged door with ASE cover and barrel nuts fitted
- 1x 3 way & 1 x 2 way connector for ASE
- 1x FP0740 FAS interface module with red, yellow and white wires
- 1x pair of red & black wires for ASE to 4100ES-S1 dc power supply
- 4x M6 screws/washers/cage nuts for mounting door
- 5x Cable ties, adhesive cable tie holders for fixing ASE wiring
- 1x Green earth lead + nut, washer for door earth
- 2x M4x16 screws + washers for ASE mounting

Addressable Loop Card – MX

MX Digital Loop Card for 4100ESi

The 4100-6077AU MX Digital Loop Card provides a 4100ESi panel with an interface to an MX TECHNOLOGY analogue addressable loop. The card supports a wide range of the MX addressable detectors, modules, sounder bases. Up to 250 devices can be connected, on up to 2km of cable.

- Connect up to 250 MX addressable devices, with up to 500mA of current per MX loop
- Up to thirty 4100-6077 MX Digital Loop Cards (total 2,000 points) per 4100ESi fire alarm control panel
- Device LEDs for alarm activation are selectable per loop with up to 5, 10, 20 or 30 to be activated simultaneously. LED blink on poll is also selectable per loop
- On-board diagnostic LEDs indicate module status for installation and service convenience
- Electrically isolated MX loop

- Earth fault monitoring of MX loop
- Mounts in a 8U, 15U, or Build-To-Order panels
- ActivFire listed to AS 7240.2-2004

MX Loop Communications provide:

- Compatibility with many types of existing cable for convenient retrofit with typical cable lengths up to 2km

With a 4100-6077AU MX Digital Loop Card:

- Information communicated to the control panel is analysed using the MX Fastlogic algorithm
- The MX Fastlogic algorithm is considered an expert algorithm that uses real fire data as a basis for the alarm decision
- WALKTEST system testing with automatic self resetting is available for silent mode testing

MX Peripherals provide:

- Soft addressing of devices using the 850EMT programming tool
- Remote programming of detectors via 2-way IR link

- Device address may be changed at the front panel

Compatible addressable devices include:

- Smoke detector, heat detector, combination smoke/heat detector and triple sensor Smoke/CO/Heat detector
- Detectors include short circuit isolator when used with 4B-C Continuity base
- Sounder bases with loop powered sounder
- Single, dual, and multiple I/O modules
- Relay and signal output modules
- Indoor and outdoor call points
- Loop powered dual Monitor ZAM
- Separate short circuit Loop Isolator Module

Addressable Loop Card – IDNet

IDNet Technology can be incorporated into the 4100ESi to communicate with legacy IDNet devices.

IDNet2 Module



Features

- The IDNet2 card has four built-in loop isolators, each with its own set of terminals. These can be wired to provide two loops of IDNet devices. Wiring faults on one loop will not affect any of the other loops.
- Removes the need for panel mounted isolators at the start and end of loops.
- The loop wiring is electrically isolated from the panel's 24V supply. Improved noise immunity eliminates the need for shielded and twisted wire in most applications.
- Collectively, up to 246 compatible external devices can be connected to the IDNet2 card. These devices generally do not need to be arranged in any special order, and can be any IDNet or IDNet-compatible MAPNET device. Addresses 247-250 are reserved for the in-built loop isolators.
- IDNet2 is a PDI format card, occupying one card position. It is 100mm wide and 127mm high
- On-board fault indicators for each loop output.
- Earth fault detection diagnostics test each output.
- Duplicate Device Detection and Weak Answer Detection.
- Diagnostics to assist in locating devices installed incorrectly

Specifications

Input Voltage	24Vdc (CIE supplied)
Loop Voltage (max)	31Vdc (nom.) (36Vdc max)
Loop Current	500mA maximum
Input Current – Module only	75mA (Q); 115mA (A)
Devices (per device)	0.8mA (Q); 1mA (Alarm)
Data Input from CIE.	RS232 ASCII
Data Output	BACnet IP
Operating Temperature	0°C to +45°C
Relative Humidity	10% to 93% (non/cond)
Dimensions (mm)	127 x 100 (HW)
Part Number	4100-3109AUK

The IDNet2+2 is an enhanced IDNet2 loop card suitable for use in SIMPLEX 4100ESi and 4100U systems. It has inbuilt addressable short circuit isolators which can be configured to provide up to four isolated loops or 8 spur circuits.

The IDNet2 and IDNet2+2 cards supercede the previous 4100-3101AU and 4100-3107AU.

IDNet2+2 Module

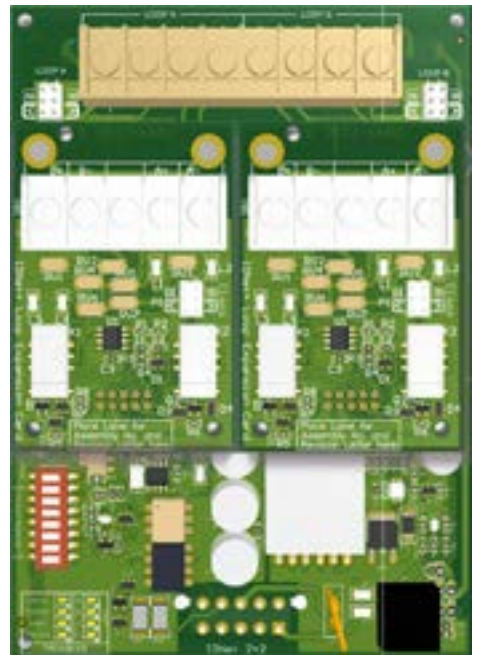

Specifications

Input Voltage	24Vdc (CIE supplied)
Loop Voltage (max)	31Vdc (nom.) (36Vdc max)
Loop Current	500mA maximum
Input Current – Module only	75mA (Q); 115mA (A)
Devices (per device)	0.8mA (Q); 1mA (Alarm)
Data Input from CIE.	RS232 ASCII
Data Output	BACnet IP
Operating Temperature	0°C to +45°C
Relative Humidity	10% to 93% (non/cond)
Dimensions (mm)	127 x 100 (HW)
Part Number	4100-3110AUK

Fire Detection Product Catalogue

Expansion Modules

A comprehensive range of expansion modules are available for the 4100ESi Fire Alarm Panel. These can be used for interfacing addressable or conventional (non-addressable) detectors adding controls, annunciators, networking or high level communications to MODBUS or VESDA systems. Expansion modules come in two form factors Legacy (for older panels) or PDI for newer systems, the 4100ESi can accommodate both types of modules, some of these are listed below.

Two 4-way and 8-way relay cards are available for use in SIMPLEX 4100ESi and 4100U systems. Each is a PDI "flat" format card, occupying a single position.



4100-3204 4 Aux Relay + Feedback PDI Card

Features

- Fit directly in 4100ESi/4100U expansion bay. Do not require a motherboard
- The 4100-3204 provides four independent relays, each providing two sets of clean change-over contacts rated at 2A and fused at 3A
- The 4100-3204 also has four unsupervised feedback inputs (ON/OFF detection only)
- The 4100-3206 provides eight independent relays, each providing a single set of clean change-over contacts, each rated at 3A and fused at 5A. There are no feedback inputs on this card
- All fuses are standard 20 x 5mm cartridge type
- All terminals have 2.5 mm sq. wiring capacity
- Both cards have individual LEDs to show relay operation



4100-3206 8 Aux Relay PDI Card



4100-5129 Ferrite Bead



FZ9028 3U WA/Cube ASE Bracket & Loom



4100-MXPK
MXP Responder I/F Card



4100-5013
8 Zone Relay Card single height, single width PDI.

Features

Provides 8 inputs/outputs. Each input/output can be configured for either:

- Conventional detector circuit operation supporting a range of fire detectors with different EOL values (3k3, 2k2, 2k0) or 6k8 with clean-contact devices only.
- Clean-contact relay output with a choice of normally-closed or normally-open contacts. The contacts are rated at 2A 30Vdc.



T-GEN 60 on FP1119 Bracket in PDI Expansion Bay with FP1118 Brackets & Splitter Modules

Expansion Modules

4100-6078	Network Card req's 2x media mod.
4100-6056	Wired Media Module, use 2 cards as req'd; mount on 4100-6078
4100-6057	Dual Core Multimode Fibre Media Module
4100-6047	Building Network I/F Card (BNIC)
4100-6301/2	Duplex Single-Mode Fibre Media Card
4100-6303/4	Duplex Multi-Mode Fibre Left Media Card
4100-9863	TCP/IP Bridge card (not AS 7240)
4100-6046V	VESDA HLI card
4100-6046	Dual RS232 HLI card
4100-3204	4x 2A DPDT Relay PDI card with Feedback inputs
4100-3206	8x 3A SPDT Relay PDI card
4100-5013	8 Zone / Relay Card
4100-3024K	24 Pt I/O relay card & 4100-0302
4100-0302K	24 Pt I/O module (exp. cabinet)
4100-4321K	6 supervised relay/signal (exp cab)
4100-6079K	SafelINC (Internet I/F) card
4100-6069	BACNet interface card (exp. cab)
557.202.508	4100 MODBUS I/F RS485 CCU3
557.202.509	4100 MODBUS I/F Ethernet CCU3
4100-1288	64/64 LED Switch Controller
4100-1277	8 Red & Yel LED Module
4100-1280	8 P/Butn 8 Red LED Module
4100-1284	8/16 P/Butn Red-Grn LED Module
4100-1282	8/16 P/Bn Red-Yel LED Module
4100-1281	8 P/Bn 8 Yel LED Module
4100-ME0456	4x AS1668 Fan Controls
4100-KT0549K	7U 8-Slot LED Door Empty

Brigade Kits

4100-ME0512K	Cube/WA ASE brkt plus mic. mntng
4100-ME0513K	Centaur ASE brkt plus mic. mntng
FP1093	NT Brigade 6U door for mounting NTFast radio

Tone Generator (BOWS)

FP1115	T-Gen 60 60W Amplifier
FP1116	T-Gen 120 120W Amplifier
FP1119	T-Gen2 PDI Bay Bracket only
ME0490	T-GEN 50 Dynamic Mic & Lead
4100-1043K	T3 Strobe Driver Module mounted on Legacy bracket

Remote Annunciator

4603-9101	Serial LCD Annunciator (not Brigade use)
FP1048	Remote Fire Brigade pane

MX Digital Loop Card

4100-6077AUK	MX Digital Loop Card for 4100ESi (double height PDI card)
ME0516	MX Digital Loop Card Bracket

Compatible Peripherals

516.850.054.E	850PC CO/Heat/Smoke Detector,
516.850.053.E	850H Heat Detector
516.850.052.E	850P Photoelectric Smoke Detector
576.080.002	P80SB Addressable Base Sounder
576.080.001	80DSB Detector Sounder Base
516.850.051.E	850PH Photoelectric Smoke Det.
517.050.042	4B-C Continuity Base
E5xx	E500Mk2 Series Remote LED Ind.
514.800.611	MCP820 MX Manual Call Point
514.800.612	IP67 MCP830 MX Manual Call Point

Addressable Interface Modules

MIM800	Mini-Input Module
CIM800	Contact Input Module
RIM800	Relay Interface Module
SNM800	Sounder Notification Module
DIM800	Detector Input Module
577.800.006	DDM800 Dual Detector Module
545.800.004	LIM800 Line Isolator Module
517.035.007	M520 Addressable Module Cover
517.035.010	K2142 Double Gang Back Box M520
555.800.065	MIO800 Multiple Input/Output Mod
557.201.401	D800 Ancillary Housing for MIO800
516.018.014K	VIO800 VESDA Interface

Device Accessories and Service Tools

850EMTK	850EMT Programming Tool Kit
516.800.917	800RT Sensor Head Removal Tool,
516.800.922	Spare ancillary programming lead
516.800.923	Accessory Kit; carrying case, strap, 12V automobile adaptor
516.800.924	Pack 10 spare pins for anc. lead

Cabinets

4100-FP1045	15U 4100ESi 10A PSU, 1 MX Loop, 1x 8 Slot Disp Door
4100-FP1046	8U Exp. Cab, window Titania, PDI only 1x7U Display Door
4100-FP1086	8U Exp. Cab, blank door, Titania, suit PDI or Legacy Cards
FP1029	8U Battery Box, Titania
4100-FP1087	15U Exp. Cab, blank door, Titania, 10A PSU
4100-FP1088	15U Exp. Cab, window, Titania, 15U Gear Plate, 2x 8 Slot display doors

Remote Unit Interface

The 4100ESi Series Remote Unit Interface (RUI) communications provide a cost-effective alternative to networking.

It involves running a cable loop from the 4100ESi control panel to remote InfoAlarm+, control panels, LCD annunciators, and Remote Transponder Units (RTU) where 4100ESi slave cards are located.

Using RUI communications may reduce cabling, installation and labour costs, can reduce the required size of the main FIP and enable larger distances to be covered.

All slave interface cards such as MX Loop Card, relays, 24 I/O, 8-Zone monitor and 6 Signal card can be fitted to RTUs. RUI communications are received by the transponder interface module and translated into the same internal communications format that is used in the host control panel.

Remotely located modules. By utilising RUI communications, the RTUs can remotely provide the same initiating and notification functions that occur at the host control panel without requiring multiple long distance wiring runs.

RUI communications can be wired in Style 4 or Style 7 redundant loop configurations up to 760m.

Up to 31 nodes can be connected to the Remote Unit Interface loop.

AS 4428.3 Fire Brigade Panel features an operator interface with InfoAlarm+ display which automatically jumps to the Alarm screen when alarms are detected.

Full zone control and status indications including enable/disable functions for up to 500 zones. Numeric keypad for point category and point selection. Six programmable control keys/LED to use for one-touch Disable/Enable of output zones such as: General Alarm, Bell/Strobe, Alarm Devices and Door Holders.

Multiple tabs are used to view and control Alarms, Priority2 Alarms, Monitor, Faults, Disable, Force Alarm (testing), and Service Diagnostics.

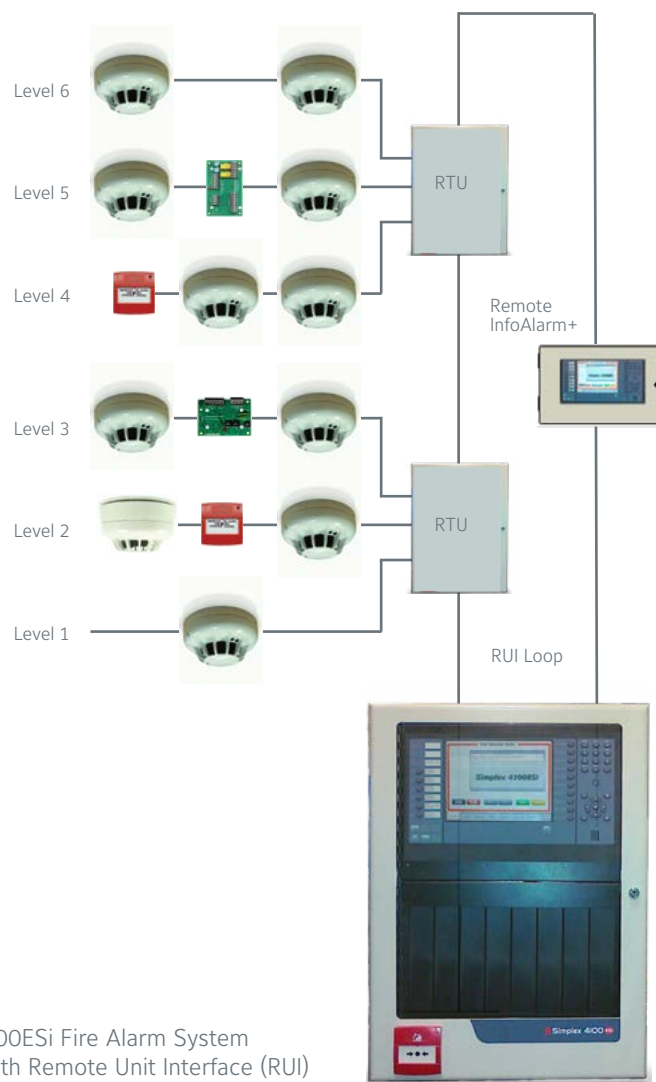

4100ESi Fire Alarm System with Remote Unit Interface (RUI)

4603-9101 Serial LCD Annunciator

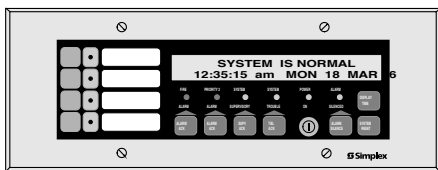

The Simplex 4603-9101 LCD annunciator provides remote annunciation and control using an 80 character, back-lit, alphanumeric, LCD readout. Information is presented in clear, descriptive English language and includes: point

status (alarm, trouble, etc.), alarm type (smoke detector, manual station, etc.), number of system alarms, supervisory conditions, and troubles, and a custom location label. Communications require a single twisted, shielded pair that supports other styles of Simplex serial annunciators on the same wire pair. Alarm, Supervisory, and Trouble conditions are also indicated by dedicated LEDs and a tone-alert. Each condition has a dedicated acknowledge push-button switch that silences the tone-alert but leaves the LED on until all conditions in that category are restored to normal. Switch operation is either globally or individually acknowledgeable, determined by the control panel operation. Repeated operation of

the appropriate acknowledge switch will scroll the LCD display showing activity in the sequence of occurrence. The tone-alert also sounds to indicate the operation of any of the push-button switches

Specifications

Operating Voltage	24Vdc, Loop Supplied
Operating Current	170 mA
Operating Temp	0 to 49°C
Relative Humidity	10% to 90% (non-cond)
Standard Trim	Steel, Painted Beige
Optional Trim	Brushed Aluminium, 4603-9111
Trim Dims(HW)	114 x 300 mm

SIMPLEX High Level Interface

SafeLINC® Fire Panel Internet Interface



SafeLINC provides continuous web-based monitoring and communication of trouble conditions – an advance in technology that results in more efficient maintenance of your system. SafeLINC also enhances the overall operation and safety of remote facilities by ensuring that problem conditions are automatically communicated to all appropriate personnel, no matter where they are located.

566-355 Simplex Internet Module

PRODUCT BENEFITS

SafeLINC helps you manage your environment by keeping abreast of fire alarm system activity, by providing information via the internet, routed to smart phones, tablets, mobile phones, pagers and computers in real time. SafeLINC is able to provide continuous web-based monitoring and communications from a single point of command and control. It can be added to any new Simplex 4100ES and to most existing Simplex 4100-series panels.

Service Gateway

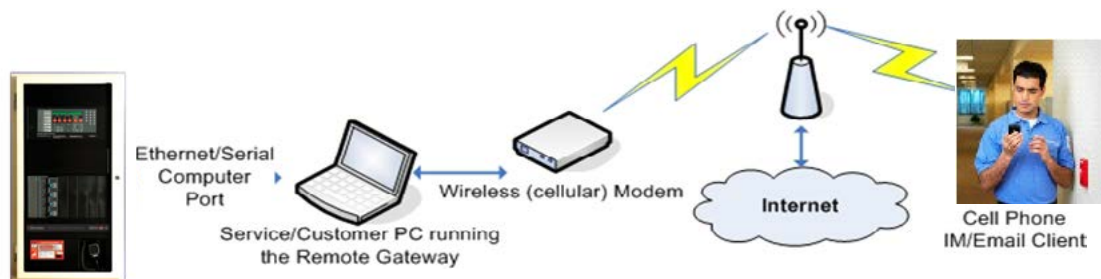

4100-6069, BACpac Ethernet Module – HLI BACnet Interface



The 4100-6069 BACpac Ethernet module provides a supplementary communications interface that converts computer terminal information from a compatible Simplex CIE into the building automation protocol of BACnet. With this module, status information from the CIE can be provided to other components of the building automation network with the detail and information format required. This allows the other systems to properly respond to fire alarm system activity in addition to the primary fire alarm response that is under the control of the CIE.

Specifications

Input Power	123mA@24Vdc (c.i.e.)
Data Input from CIE	RS232 ASCII
Data Output	BACnet IP
Operating Temperature	0°C to +45°C
Relative Humidity	10% to 93% (non/cond)
Dimensions (mm)	2654x51x105 (HWD)

VESDA® High Level Interface



4100-0154K Motherboard (lower - fitted to the 4100ES FIP) and Interface Module (upper - fitted into the Motherboard)

SIMPLEX/VESDA High Level Interface (HLI) allows SIMPLEX addressable fire detection panels to gather and process status information from VESDA LaserPLUS and LaserSCANNER high sensitivity air aspiration smoke detection systems. Hardware requirements include an Intelligent Interface Module installed in the fire alarm control panel and an HLI Module installed in the VESDA smoke detection equipment. The combination of VESDA smoke detection and the extensive features of the Simplex addressable panel allows mission critical and high value facilities to be equipped with a low level smoke detection system that can provide very early warning of the presence of incipient fire conditions.

Specifications

Operating Voltage	18 to 32Vdc*
Current	132mA
Communications Space (4100/4120)	RS-232, 9600 baud, 6m max Plugable module requires 51mm int. rack width

Space (4020)	Flat module 133x267(WH)
Relative Humidity	10% to 95% (non cond.)
Ambient Temp	0°C to +49°C
Weight	81g

Part Numbers

4100-0154K	4100 Panel Mount Module
VHX-0400	VESDA Mounted Module (Current - 70mA)

* MAPNET II addressable loop voltage

SIMPLEX 4100 Network Systems

Features

- Fast Network Speed - typically 4 second response time
- Full site control from one location
- Communicates Information along remote Fire Alarm Control Panel locations (defined as Network Nodes)
- Initiates Alarm Silence, Acknowledge and Reset
- Displays status of selected circuit points, point lists and network nodes
- Investigates specific point status details
- Declares system alarm from Control Panels
- Network Nodes include:-
 - 4100 series Fire Alarm Control Panels
 - 4100 series Network Processing Units (NDU), Network Display Units (2500NDU) and MINIPLEX and Universal Transponders (UT)
 - 4190 series TrueSite Workstation
- Retrofit into existing 4100 systems
- TrueAlarm Sensor Operation:-
 - Read status of TrueAlarm Analogue detection sensors at multiple locations
 - Remote or local sensitivity selection
- Style 7 or Style 4 wired communications:-
 - Single wire pair between nodes
 - Up to 3.5km between nodes with 1.0 mm² twisted shielded wire
- Optional Fibre Optics communications
- Full Network communication supervision:-
 - Network level diagnostics
 - LED Status indications on interface board
- Set host function accesses remote node data
- Remote dial-in modem for off-site data access
- Optional TCP/IP communications
- T+ over Copper or single/multimode Fibre Optic cable
- Up to 99 panels on one network ring

Maximum Distances for Networks

- Single pair of 24 AWG Telephone wire - 3,500m between network panels
- Single core multimode Fibre Optic Cable up to 5000m between panels
- Single core single mode fibre media up to 25Km between panels
- Signal is regenerated at each panel before re-transmission
- 4 seconds network response time

Flexible Network Communications

Campus Style Network Multiple Connectivity Options

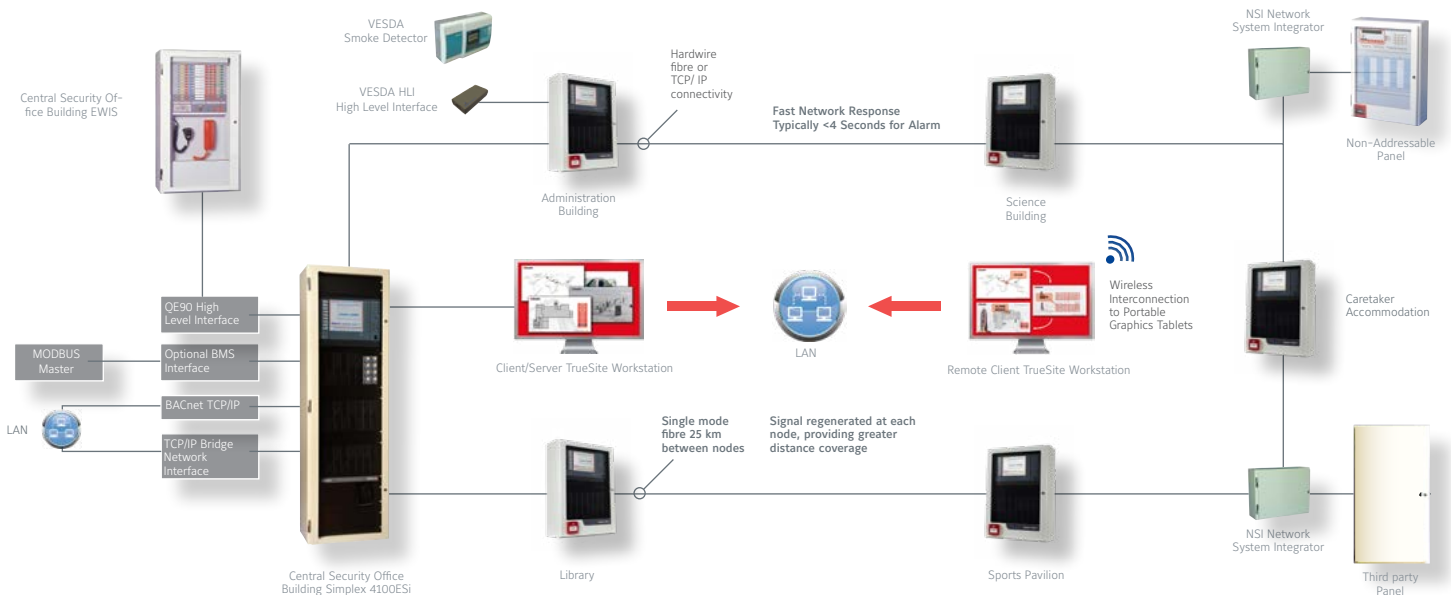

BNIC

Building Network Interface Card (BNIC)

The BNIC allows connection of a 4100ES FIP to a local area Ethernet network (LAN) or to a dedicated Ethernet network used only for the fire alarm system.

The BNIC isolates the FIP from the external or building network but allows an authorised user to access the FIP through the network. Network authorisation is provided transparently through service tools such as the ES Programmer.

Part Number 4100-6047



4100ES Network Cards

- | | |
|-------------|---|
| 4100-6014AU | Modular Network Card (requires 2 media cards) |
| 4100-0142 | Wired Media Card RS485 including Ferrites |
| 4100-6057 | Dual Core Multimode Fibre Media Module |
| 4100-9863 | TCP/IP Physical Bridge Card |
| 4100-6072 | Fibre Optic Modem Left Port Assembly |
| 4100-6073 | Fibre Optic Modem Right Port Assembly |
| 4100-6301/2 | Duplex Single-Mode Fibre Media Card |
| 4100-6303/4 | Duplex Multi-Mode Fibre Left Media Card |

The Fibre Optic Modem is used to simplify field wiring and increase transmission distances by converting system copper-wired interfaces to fibre optic connections. A Modem pair replaces copper wiring between any two points including node-to-node, node-to-transponder, and transponder-to-transponder. The Modem is invisible to the connected equipment, and does not need to be programmed in as part of the job (except for power supply current calculations). The Modem combines the input signals so they can be communicated over one fibre in both directions. In general, the Modem installation is accomplished by simply connecting the wires that would normally be routed between cabinets to the Modem.

TrueSite Workstation Network

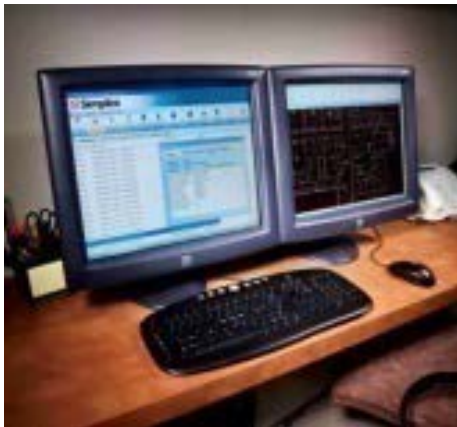

A Powerful Platform for Centralised Management
When it comes to managing the wide array of information that drives a large fire alarm network, the TrueSite system stands out for its power, flexibility and ease of use. A PC based graphical command centre that runs Microsoft WINDOWS, the TrueSite Workstation can seamlessly accept and process information from literally thousands of detectors, notification appliances and other network devices.

The system's power is evident in its ability to:

- Monitor and control up to 100,000 devices
- Support seven network loops and as many as 686 panels
- Monitor any brand of control panel using agency listed digital alarm communicators
- Store historical data for up to 1,000,000 events
- Graphically display information and events on a campuswide site map and individual building floor plans.

What can TrueSite do for you?

- Strengthen protection of life and property through centralised life safety information management
- Help accelerate emergency response and control training costs with intuitive graphical interface and event-specific operator instructions
- Improve operational efficiency through quick access to information and customisable menus
- Protect your investment and prepare for the future with forward-backward compatibility

Mobile Client

The TrueSite Workstation Mobile Client brings the features and functionality of the TrueSite Workstation to your Apple or Android™ mobile device or tablet. Available from iTunes* and Google Play™, the TrueSite Mobile Client helps you access and monitor your facility's TrueSite Workstation remotely, giving you the flexibility to view system information and diagnostics wherever you are.

Mobile Client Features:

- Connect an unlimited number of Mobile Clients to your TrueSite Workstation with the purchase of one client license
- Monitor up to 686 nodes on seven network loops
- Display of Fire Alarm and Priority 2 Alarm conditions
- Display of Supervisory Service and Trouble conditions
- Secure internet connectivity
- System control operations: Alarm Silence, System Reset, Audio Control

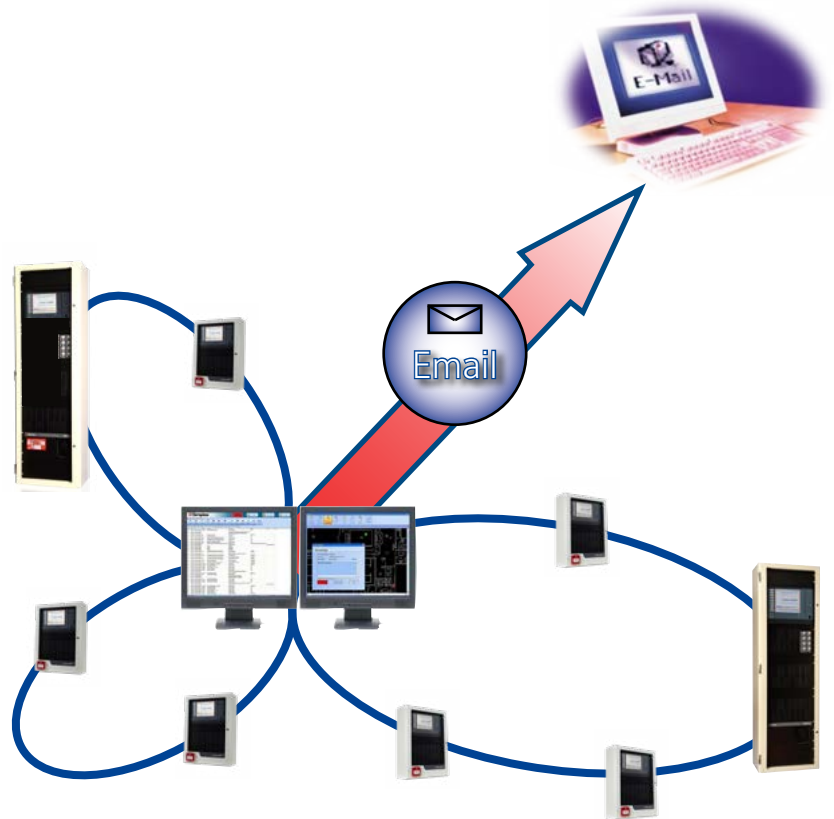

TrueSite Workstations provide annunciation, status display, and control for Simplex Fire Alarm Networks using a PC based graphical interface with a high resolution colour display. Response buttons with realistic icons provide control switches specific to the operation being performed. Multiple Workstations can be installed on the same network for redundancy or to route (vector) point type annunciation to the appropriate workstation depending on type, location, or other criteria. A separate TrueSite Workstation can also be dedicated as a maintenance terminal for performing higher level network operations. With touchscreen monitors, the operator touches the screen area in alarm (or uses the mouse) to access a more detailed view of the alarmed zone or device. With the proper password access, the operator has the ability to acknowledge alarm conditions, activate signal silence, and perform system reset directly from the workstation screens.

Part Numbers

4190-8603	TSW Software Package
4190-5050	TSW Server Software
4190-5061	TSW Feature Code for Remote Client w/ Restricted Feature Set
4109-5062	TSW Feature Code for Remote Client with Password-Protected Feature Set
4190-DELL	Single network server/client PC
4190-7026	Commack industrial 2+ network loop PC
4190-9829	IMS & TrueSite wired Network Card (PCI slot)
4190-9822	IMS and TrueSite Wired Media Card - RS485
4190-9823	Dual Core Multimode Fibre Media Module
4190-5067	TSW Mobile Client Feature Code Suits Apple and Android devices (See note 9)
4190-6301/2	Duplex Single-Mode Fibre Media Card
4190-6303/4	Duplex Multi-Mode Fibre Left Media Card



TrueAlarm Addressable Detectors *For 4100ESi MX detectors + devices refer page 16ff*

4098-9754EA Photoelectric & Heat Multi-Sensor



TrueAlarm multi-sensor 4098-9754EA combines the TrueAlarm photoelectric smoke sensor with a fast-acting and accurate TrueAlarm thermal sensor to provide both features in a single sensor/base assembly. Analog information from each sensor is digitally communicated to the control panel where it is analysed.

Photoelectric sensor input is stored and tracked as an average value with an alarm or abnormal condition being determined by comparing the sensor's present value against its average value. Thermal data is processed to look for absolute or rate-of-rise temperature as desired.

Monitoring each photoelectric sensor's average value provides a software filtering process that compensates for environmental factors (dust, dirt, etc.) and component aging. The result is a significant reduction in false or nuisance alarms caused by shifts in sensitivity.

Specifications

4098-9754E	
Operating Voltage (MAPNET II)	24 to 40Vdc
Operating Current (MAPNET II)	500µA (max)
Relative Humidity	10% to 95% (n/cond)
Ambient Temperature	0 to +50°C
Sensitivity (at CIE)	4 and 5%Obs/m
with 4098-9795E	
Alarm Current (sounder on)	17mA @ 24Vdc
Sounder Power (external)	18 to 32Vdc
Sound Pressure Level	88dBA @ 3m
ActivFire Listed (MAPNET)	afp-1361
Part Numbers	
4098-9754EA	Detector
4098-9796EA	Base
4098-9795EA	Sounder Base

*MAPNET II or IDNet auto select w/data

4098-9714EA TrueAlarm Photoelectric Smoke



The 4098-9714EA Photoelectric smoke detector contains a state-of-the-art sensing chamber and analogue communication electronics. Used in conjunction with the Simplex 4100 panel, the 9714E has a high degree of false alarm immunity thanks to advanced algorithms.

The detector mounts on the 4098-9789 addressable base or 4098-9794 sounder base. An optional remote LED can also be fitted.

Specifications

Operating Voltage	24 to 40Vdc*
Quiescent Current (max)	100µA
Alarm Current-relay active	24mA
External Output Drive (max)	5mA
Relative Humidity	10% to 95% (n/cond)
Ambient Temperature	-9°C to +50°C
Air Velocity	0 to 610m/min
Sensitivity	4 to 6% Obs/m
ActivFire Listed	afp-1225
Part Number	4098-9714EA

*MAPNET II or IDNet auto select w/data

4098-9717EA TrueAlarm Ionisation Smoke



Note that this device is shown for historical reference only. It is no longer available.

The 4098-9717EA Ionisation detectors use a single radioactive source with an outer sampling chamber and an inner reference chamber to provide stable operation under changes in environmental conditions eg., temperature and humidity. Smoke and invisible combustion gases can freely penetrate the outer chamber. The air in both chambers is ionised by a small radioactive source causing a very small current to flow in the circuit. The presence of combustion particles causes a change in the voltage ratio between chambers, which is measured by the electronics in the base and digitally transmitted to the CIE for processing.

Specifications

Operating Voltage	24 to 40Vdc*
Quiescent Current (max)	400µA
Alarm Current-relay active	24mA @ 24V
External Output Drive (max)	5mA
Relative Humidity	10% to 95% (n/cond)
Ambient Temperature	0 to +50°C
Air Velocity	0 to 61m/min
Sensitivity	0.4 MIC X nom.
Source	Americium241
ActivFire Listed	afp-1246
Part Number	4098-9717EA

*MAPNET II or IDNet auto select w/data

4098-9733EA TrueAlarm Heat Detector



TrueAlarm heat detectors are self-restoring and provide rate compensated, fixed temperature sensing, selectable with or without rate-of-rise temperature sensing. Due to its small thermal mass, the detector accurately and quickly measures the local temperature for analysis at the CIE Rate-of-rise temperature detection is selectable for either 8.3°C or 11.1°C per minute. Fixed temperature sensing is independent of rate-of-rise sensing and programmable to operate at 57.2°C or 68°C. In a slow developing fire, the temperature may not increase rapidly enough to operate the rate-of-rise feature, however an alarm will be initiated when the temperature reaches its rated fixed temp. setting.

Specifications

Operating Voltage	24 to 40Vdc*
Quiescent Current (max)	400µA
Alarm Current (max)	10mA
External Output Drive (max)	5mA
Relative Humidity	10% to 95% (n/cond)
Ambient Temperature	0 to +50°C
ActivFire Listed	afp-1202
Part Number	4098-9733EA

*MAPNET II or IDNet auto select

Fire Detection Product Catalogue

4098-9789EA TrueAlarm Analogue Addressable Detector Base



TrueAlarm detector bases contain integral addressable electronics that constantly monitor the status of the detachable photoelectric, ionisation, or heat detectors. Each detector's output is digitised and transmitted to the system CIE every four seconds. Since TrueAlarm detectors use the same base, different detector types can be easily interchanged to meet specific location requirements, for example, during building construction, or when conditions are temporarily dusty. Instead of covering the smoke detectors (causing them to be disabled), heat detectors may be installed without reprogramming the CIE. Although the CIE will indicate an incorrect detector type, the heat detector will operate at a default sensitivity maintaining building protection at that location.

Specifications	
Operating Voltage	24 to 40Vdc*
Quiescent Current (max)	400µA
Alarm Current (max)	3.2mA
Relative Humidity	10% to 95% (n/cond)
Ambient Temperature	0 to +55°C
Dimensions	124 dia x 35mm
ActivFire Listed	afp-1225 & 1246
Part Number	4098-9789EA

*MAPNET II or IDNet auto select

4098-9794EA TrueAlarm Analogue Addressable Sounder Base



The TrueAlarm sounder base has a built-in Piezoelectric sounder that provides a high 90dBA output with low 17mA current requirements. Used with the interchangeable TrueAlarm detectors (photoelectric, heat, or ionisation) the sounder can be powered from 24 Vdc or from a compatible Notification Appliance Circuit (NAC) and synchronised coded/temporal coded by communications* or by the NAC. The sounder can be manually activated from the CIE. Analogue detector information is digitally communicated to the control panel via MAPNET II™ or IDNet™, two-wire communications**. Detector information is processed by the CIE to determine detector status.

The sounder base has a built-in magnetic test feature and is for use with Simplex CIEs model 4010/4020/4100/4120, and Universal Transponders. Optional accessories include remote alarm LED indicator on single gang plate and an alarm LED tracking relay.

Specifications	
Sounder Operating Voltage	24 to 40Vdc*
Relay Voltage	18 to 32Vdc
Quiescent Current (max)	270µA
Alarm Current (max)	17mA
Sound Pressure Level	90dBA @ 3m
Relative Humidity	10% to 95% (n/cond)
Ambient Temperature	0 to +55°C
Dimensions	124 dia x 35mm
ActivFire Listed	afp-1246
Part Number	4098-9794EA

*MAPNET II or IDNet auto select

4098-9793EA TrueAlarm IDNet Isolator Base



TrueAlarm analog sensors and provides communications isolation to improve installation convenience and increase system integrity. An internal isolation relay allows a compatible c.i.e. to separate shorted communications wiring from functioning wiring to optimise the available sensors or other IDNet addressable devices. The isolator base's status is communicated to the FIP, allowing it to assist in identifying the location of the shorted wiring. During installation, earth faults frequently occur. Finding these faults normally requires extensive wiring disconnection. With the 4098-9793 isolator base, earth faults on the IDNet communications lines can be quickly located to assist in their repair and to restore the system wiring to normal.

Specifications	
Operating Voltage	24 to 40Vdc*
Input Voltage	18.9 to 32Vdc
Current (max. @ 24Vdc)	500µA
Supervisory Resistor (9101)	3k3 Ohm 1W
Dimensions (HWD)	105x105x35mm
Relative Humidity	10% to 95% (n/cond)
Dimensions	124 dia x 35mm
Ambient Temperature	-9°C to +50°C
Part Number	4098-9793EA

*IDNet, 1 address per base

The 4098-9793 isolator base accepts Simplex

4098-9755EA Duct Sampling Unit



The TrueAlarm duct sampling unit detects the presence of smoke in air conditioning or ventilating ducts. Sampling tubes are installed into the duct and air is directed to a 4098-9714EA smoke sensor mounted in the housing.

These duct housings provide the high reliability performance of TrueAlarm analog sensing featuring programmable sensitivity, consistent accuracy, environmental compensation, status testing, and monitoring of sensor dirt accumulation.

The TrueAlarm Duct Sampling Unit require only two wires for both communications and power.

Specifications	
Operating Voltage	18 to 40Vdc*
LED Current	600µA**
Air Velocity	1.5 to 20 m/s
Relative Humidity	10% to 95% (n/cond)
Operating Temperature	0 to +50°C
4098-9753 with auxiliary relay	
Relay Coil Voltage	18 to 32Vdc
Quiescent Current	240µA @ 24Vdc
Alarm Current	32mA @ 24Vdc
Contact Rating	1A @ 28Vdc (pwr limit)
Contact Rating	0.5A @ 120VAC (resist)
ActivFire Listed	afp-1354
Part Numbers	
4098-9755EA	DSU
4098-9856	Sampling Tube 1.2m

*MAPNET II

** No impact on alarm current

TrueSTART II Analysis and Testing Instrument



The Simplex TrueSTART II Test Tool is a portable battery-operated test instrument, designed to enable contractors or technicians to quickly verify that all IDNet wiring and peripheral devices are installed correctly and operating properly, even before they are connected to the 4100 fire alarm control panel. The TrueSTART II instrument uses advanced software technology to scan hundreds of addressable fire alarm system devices and pinpoint potential problems, such as ground faults, shorted wiring, or incorrect or duplicate addressing.

Specifications	
Operating Voltage	24 to 40Vdc
Battery Life (approx.)	6 hours of testing
Relative Humidity	10% to 95% (n/cond)
Ambient Temperature	0 to +55°C
Part Numbers	
TSIT-AUK	TrueSTART II Kit incl. Li-ion battery,
AC	adaptor, carry bag, test leads, manual
TSIT-ALEADS	TrueSTART II Replacement Leads

SIMPLEX Addressable MAPNET II Modules

The MAPNET II Modules are for use on older systems only.

4100-0110K Addressable Loop Modules

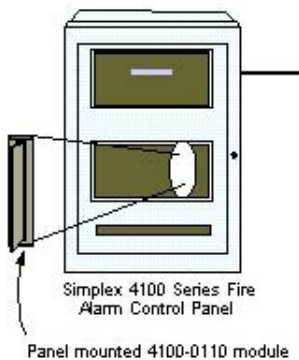

Model 4100-0110 addressable modules communicate with remote addressable devices to provide initiation, notification, and control. Operating over a two wire MAPNET II circuit, individual initiating devices such as smoke and heat sensors, manual fire alarm stations, and sprinkler flow switch contacts can communicate their identity and status. Individual addressability allows the location and the condition of each device to be displayed on the 4100 control panel and on system annunciators. Additionally, notification appliance circuits (horns, bells, strobes, etc.) as well as other control circuits (fans, dampers, etc.) may also be individually controlled.

Up to a combined total of 127 addressable monitor and control devices may be intermixed on the same common pair of wires. Multiple 4100-0110 modules may be installed to accommodate a system capacity of up to 1000 addressable devices (control panel dependent). MAPNET II operation continuously interrogates each addressable device on its communication channel for status changes. Two-way data communication are supported over a multi-drop, "T-tapped" pair of wires for any combination of up to 127 monitor and control points. The digital poll/response techniques used ensure high supervision integrity and will report alarm and trouble conditions to the control panel.

2190-9173 2 Point I/O Module

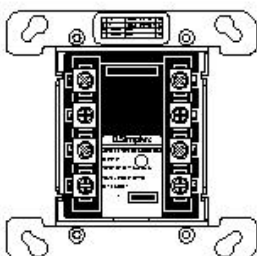

The 2190-9173, 2-Point I/O module allows a Simplex MAPNET II communication channel to monitor an input contact closure and control an output relay from a single compact module. Module power is supplied from the MAPNET II communications channel. The monitor and control points can be applied for a variety of associated or independent operations. Flexible programming abilities at the host panel can provide the association logic required for a wide variety of fire or utility operations

Specifications	
Operating Voltage	24 to 40Vdc*
Address Assignment	2 addresses req'd
Dimensions (HWD)	105x105x35mm
Relative Humidity	10% to 95% (n/cond)
Ambient Temperature	0 to +49°C
Part Number	2190-9173

*MAPNET II

Fire Detection Product Catalogue

2190-9162 Zone Adaptor Module - Signal and Control

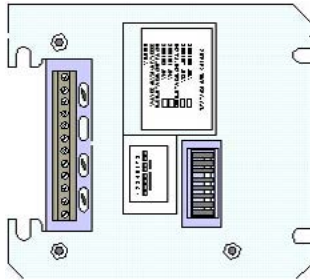

Signal ZAMs are used to supervise and operate 24 Vdc notification appliances, speakers, and telephone circuits. Output capacity is up to 2 A @ 24 Vdc, or 50 W of 25 VRMS speakers, or up to 3 simultaneously activated firefighter phones. The signal ZAM is available for either Style Y/Class B or Style Z/Class A operation for notification appliance circuits.

This part has been replaced by 4090-9007. This information is for reference only.

Specifications

Operating Voltage	24 to 40Vdc*
Supervisory Current (24Vdc)	15mA (9159-9162) 10mA (9163/9164) 65mA (9159/9160) 40mA (9161-9164)
Alarm Current (24Vdc)	
Dimensions (HWD)	105x105x35mm
Relative Humidity	10% to 95% (n/cond)
Ambient Temperature	0 to +49°C
Part Number	2190-9162

*MAPNET II

2081-9027 Isolated Loop Circuit Protector

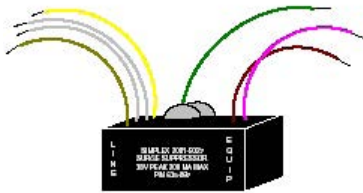

Electrical transients caused by lighting or by disturbances on high voltage power lines are conditions that require low voltage wiring circuits to be adequately protected. This protection is most effective when placed at the location where such circuits leave or enter the building. The Simplex 2081-9027 Isolated Loop Circuit Protector (ILCP) is designed to protect Simplex Fire Alarm circuits from those transients induced on wire runs that are routed to the building externally. Because of its small size, it can be easily mounted at the best location.

Specifications

Line to Line	38Vdc, 28VAC RMS
Line to Ground	38Vdc, 35VAC RMS
Shield to Ground	48Vdc, 33VAC RMS
Current Each Leg	200mA max.
Resistance	3 Ohm per line*
Response Time	1x10 ⁻⁹ s (line-line) 25x10 ⁻⁹ s (line-gnd)
Max. Current (line-line)	2000A (10x50µs pulse)
Max. Current (line-gnd)	2000A (8x20µs pulse)
Max. Current (shield-gnd)	5000A (10x50µs pulse)
Dimensions (LWD)	625x35x27mm
Part Number	2081-9027

* Signal Input to Signal Output

SIMPLEX Addressable MAPNET II/IDNet Modules

4190-9050 Analogue Monitor Zone Adaptor Module



SIMPLEX AMZs provide an accurate, multi-featured 4-20mA interface for connecting analog sensors to Simplex addressable fire detection panels. The panel monitors the sensor and annunciates whenever a selected threshold level or fault condition is observed. Typical applications include: gas, air, liquid temperature, humidity, and air velocity sensing. The maximum distance from AMZ to a sensor is 1km. Each AMZ requires an address and up to 100 AMZs can be connected per panel.

Specifications

Operating Voltage	18 to 32Vdc*
Sensor Output	Switched input voltage
Sensor Current	400mA (max.)
Basic AMZ Current	30mA
Sensor Loop Current	20mA (max.)
Fault Current	5mA
2098-9808 LED Annum.	3mA
Relative Humidity	10% to 90% (n/cond)
Ambient Temperature	0 to +38°C
Part Number	4190-9050

*MAPNET II

RACO232 MAPNET II ZAM Mounting Box



Boxes for mounting Zone Adaptor Modules (ZAMs) are available in 2 sizes. Both boxes are of welded steel construction, galvanised for corrosion protection. The ZAM boxes both feature round and eccentric knock-outs for cable entry on each surface.

Specifications

Dimensions (mm)	120 sq. x 54 deep
Volume	688cc
Material	Welded Steel
Part Numbers	
RACO232	Box
4090-9802	Cover Plate

SIMPLEX Addressable IDNet Modules

4090-9002 Relay IAM (Individual Addressable Module)



The 4090-9002 Relay IAM allows the CIE to control a remotely located Form "C" Relay contact using IDNet addressable communications for both data and module power. Typical applications are for switching local power for control functions such as magnetic door holders, or control of HVAC components, pressurisation fans, dampers, etc. Relay contact status is also communicated to the CIE. The address is set by DIP switch under the resealable label.

Specifications

Comms Power ¹	24 to 40Vdc w/data
Relay Contact Ratings SPDT	0.5A @120VAC ² 2A@24Vdc ³ 1A@24Vdc ⁴
Current Limited Op	1k8/4k7 0.5W
Dimensions (HWD)	105x105x35mm
Ambient Temperature	0 to +49°C
Relative Humidity	10% to 93% (n/c)
Part Number	4090-9002

1. IDNet communications with data
 2. Transient suppressed load
 3. Inductive load
- Note: Loop powered 2 wire device

4090-9007 Signal IAM

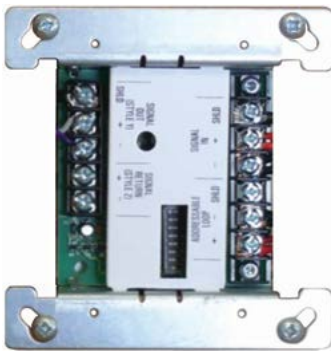

This IDNet addressable device provides a supervised, addressable interface to conventional warning devices such as sounders or strobes. The Signal IAM requires a supervised power supply or compatible signal input for powering the externally connected loads.

- Provides a single switched branch with supervision
- Contact is fused at 0.5A for 30V DC or 70V AC. Uses standard 20 x 5mm cartridge fuse
- EOLR is 10k.
- DC loads must be diode isolated
- Supervision cannot be disabled
- The supply side and the internal fuse are not supervised by the Signal IAM
- Signal IAM is not suitable for switching 100V audio signals

Specifications

Operating Voltage	24Vdc, Loop Supplied
Operating Current	170 mA
Operating Temp	0 to 49°C
Relative Humidity	10% to 93% (non-cond)
Dimensions	102 x 105 x 32 mm
Part Number	4090-9007

4090-9008 Dual Contact Relay IAM

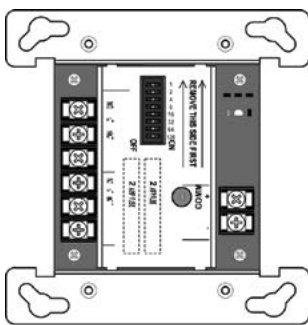

The 4090-9008 Dual Contact Relay IAM allows fire alarm control panels to control two remotely located Form "C" contact using IDNet or MAPNET II addressable communications for both data and module power. Typical applications would be for switching local power for control functions such as elevator capture, or control of HVAC components, pressurization fans, dampers, etc. Relay status is also communicated requiring only one device address.

Specifications

Operating Voltage	24Vdc, Loop Supplied
Operating Current	170 mA
Relay Contact Current	2A @ 30Vdc (resistive) 1A @ 30Vdc (inductive)
Operating Temp	0 to 49°C
Relative Humidity	10% to 93% (non-cond)
Dimensions	102 x 105 x 32 mm
Part Number	4090-9008

4090-9101 Zone Adaptor Module (ZAM) - Monitor



The 4090-9101 Zone Adaptor Module Monitor ZAM allows a 2-wire circuit of conventional smoke or heat detectors to be interfaced on to the IDNet loop.

Up to 20 conventional heat and smoke detectors can be monitored by a 4090-9101 Monitor ZAM. The address is set by DIP switch under the resealable label.

Note the 4090-9101 requires a separate 24Vdc power supply to power the conventional circuit.

Specifications

Comms Power ¹	24 to 40Vdc w/data
Operating Voltage	18.9 to 32Vdc
ZAM Current @ 24Vdc ²	Quiescent 16mA max. Alarm 72mA max.
Supervision Resistor	3k3 Ohm 1W
Dimensions (HWD)	105x105x35mm
Ambient Temperature	0 to +49°C
Relative Humidity	10% to 93% (n/c)
Part Number	4090-9101

1. IDNet Communications with data
2. Actual current value is determined by total device requirements

4090-9116 Analogue Addressable Line Isolator



The 4090-9116 Isolator provides IDNet communications isolation, improving installation convenience and system integrity. Isolation is automatically activated when an output short circuit is detected and the condition is reported to the CIE. Circuit isolation can also be selected manually from the 4100ES CIE to enable partial loop testing. If the output wiring is acceptable, the isolator will connect the rest of the circuit. If the output wiring is shorted, the isolator remains isolated. The address is set by DIP switch under the re-sealable label.

Specifications	
Comms Power ¹	24 to 40Vdc w/data
Dimensions (HWD)	105x105x35mm
Ambient Temperature	0 to +49°C
Relative Humidity	10% to 90% (n/c)
Part Number	4090-9116

1. IDNet communications with data

4090-9117 Analogue Addressable Power Isolator

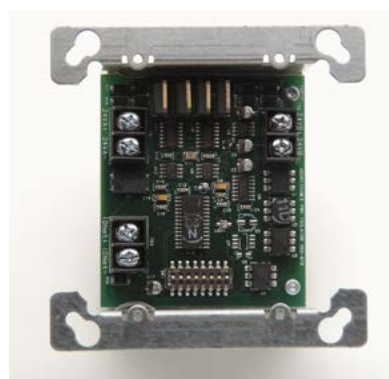

The 4090-9117 Power Isolator provides monitoring and short circuit protection for 24Vdc power wiring to IDNet addressable devices. In the event of a short circuit, it opens a two-pole electronic switch, isolating both power circuit conductors. This function can also be selected from the CIE. The isolator reports to the CIE when it is in isolation mode. It also reports the extent of shorted wiring by identifying the addresses of non-communicating devices

Specifications	
Comms Power ¹	24 to 40Vdc w/data
Current Rating	2A@32Vdc max.
Input Current	10mA@24Vdc
Dimensions (HWD)	105x105x35mm
Ambient Temperature	0 to +49°C
Relative Humidity	10% to 90% (n/c)
Part Number	4090-9117

1. IDNet communications with data

4090-9118 Relay IAM (Individual Addressable Module) with T-Sense Input



The 4090-9118 Relay IAM with T-Sense allows a 4100ES IDNet communication channel to monitor two input contact closures with one point and control an output relay with the other point, yet occupy a single loop address. Power is supplied from the IDNet communications channel, eliminating the need for separate power wiring. The input circuit and relay operation are controlled independently and may be disabled separately. Applications include water flow and tamper switch monitoring and control and damper position monitoring and control

Specifications	
Comms Power ¹	24 to 40Vdc w/data
Relay Contact Ratings SPDT	0.5A @120VAC ² 0.25A@120VAC ³ 2A@30Vdc ² 1A@30Vdc ³
Input	N/O, dry contacts
Current Limited Operation	1k8/4k7 0.5W
Dimensions (HWD)	105x105x35mm
Ambient Temperature	0 to +49°C
Relative Humidity	10% to 90% (n/c)
Part Number	4090-9118

1. IDNet communications with data

2. Resistive Load

3. Inductive Load

Note: Loop powered 2 wire device

4090-9119 Relay IAM (Individual Addressable Module) with Unsupervised Input



The 4090-9119 allows a 4100ES IDNet communication channel to monitor an unsupervised input contact with one point and control an output relay with the other point, yet occupy a single address. The input circuit and relay operation are controlled independently and may be disabled separately. Module power is supplied from the IDNet communications channel eliminating the need for separate power wiring. The address is set by DIP switch under the re-sealable label.

Specifications	
Comms Power ¹	24 to 40Vdc w/data
Relay Contact Ratings SPDT	Non power limited 0.5A @120VAC ² 0.25A@120VAC ³ Power limited 2A@30Vdc ² 1A@30Vdc ³
Input	N/O, dry contacts
Dimensions (HWD)	105x105x35mm
Ambient Temperature	0 to +49°C
Relative Humidity	10% to 95% (n/c)
Part Number	4090-9119

1. IDNet communications with data

2. Resistive Load

3. Inductive Load

Note: Loop powered 2 wire device

This part has been replaced by 4090-9118. This information is for reference only.

4090-9120 Six Point I/O Module with T-Sense Inputs and Relay Outputs Module



The 4090-9120 allows 4100ES IDNet communication channel to monitor four T-sense input circuits and control two output relays from a single module requiring a single address. Power is supplied by a separate 24Vdc connection to a listed fire alarm power supply. The input circuits and output relay operation are controlled independently and may be disabled separately. Point association is determined at the 4100ES host panel. At the 4100ES, the device address is designated as a single hardware location. Each of the four input circuits monitors for continuity to an end-of-line resistor and can differentiate between a short circuit contact closure and a current limited contact closure. Two input supervision resistors are required per T-sense input.

Specifications	
Comms Power ¹	24 to 40Vdc w/data
Operating Voltage	18 to 32Vdc
Operating Current	30mA@24Vdc
Relay Contact Ratings SPDT	
Non-power limited	0.5A @120VAC ² 0.25A@120VAC ³
Power limited	2A@30Vdc ² 1A@30Vdc ³
Supervision Resistor	6k8 Ohm 0.5W
Current Limited Operation	1k8/4k7 0.5W
Input	N/O, dry contacts
LED Output	24Vdc (external PSU)
Dimensions (HWD)	105x105x35 mm
Ambient Temperature	0 to +49°C
Relative Humidity	10% to 90% (n/c)
Part Number	4090-9120

1. IDNet communications with data
 2. Resistive Load 3. Inductive Load
 Note: 4 wire device; requires separate 24Vdc and IDNet communication loop

4090-9051 Encapsulated Supervised IAM

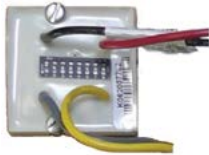

This MAPNET II / IDNet addressable device is an encapsulated version of 4090-9001. It has both power and communications supplied by a two-wire IDNet circuit. It provides location specific addressability to a single initiating device (such as single station smoke detector alarm contacts or heat detector contacts) or multiple devices at the same location by monitoring normally open dry contacts and the wiring to an end-of-line resistor.

Specifications	
Operating Voltage	24 to 40Vdc*
Operating Current	170 mA
End-of-Line Resistor	6k8 Ohm 0.5W
Operating Temp	0 to 49°C
Relative Humidity	10% to 93% (non-cond)
Dimensions	40 x 40 x 14 mm
Part Number	4090-9051

*IDNet, 1 address per unit

2975-9006 IDNet ZAM Mounting Box



Boxes for mounting Zone Adaptor Modules (ZAMs) are available in 2 sizes. Both boxes are of welded steel construction, galvanised for corrosion protection. The ZAM boxes both feature round and eccentric knock-outs for cable entry on each surface.

Specifications	
Dimensions (mm)	101 sq. x 54 deep
Volume	490cc
Material	Welded Steel
Part Numbers	
2975-9006	Box
4090-9802	Cover

4099-9701 Manual Call Point



Specifications	
Comms Power ¹	24 to 40Vdc w/data
Dimensions (HWD)	86x87x35mm
Ambient Temperature	-9°C to +70°C
Relative Humidity	10% to 95% (n/c)
ActivFire listed	afp-2889
Part Numbers	
4099-9701	IDNet & red LED
4099-9702	MAPNET II, no LED
515.001.025	Spare Glass (pk 5)
SR3T-P	Backbox

1. MAPNET II or IDNet communications with data

The 4099-9701 addressable Manual Call Point (MCP) provides a means to manually initiate a fire alarm condition to the 4100ES CIE via the IDNet channel. The IDNet channel provides the communication link and power between the call point and 4100ES. Activation of the MCP requires the frangible element to be broken, which causes contacts on a microswitch to close, initiating an alarm condition. Call Point reset requires the fitting of a replacement frangible element. The MCP features an integral red LED status indicator. The Simplex 4099-9702 MCP is connected to Simplex CIE. via MAPNET II and does not have a status indicator. If required, the SR3T-P backbox is ordered separately.

Detector Accessories & Remote Indicators

Accessories



PA0838 ZAU401 Zone Adaptor Unit
 The ZAU401 (Rev 2) can be thought of as a single zone circuit module that can be added to different panels to make them compatible with specific detectors. For example, it can be used with the S231i+ flame detector. (Refer PBG0080). In addition, the AZC characteristics of the ZAU401 make it particularly suitable for Intrinsically Safe applications when used with I.S. barriers (refer PBG0081). The ZAU401 (Rev 2) can support up to 2mA of quiescent detector current and uses a 3k9 5% ELD resistor. The detectors must provide current limiting in alarm,

or a series resistor must be included to limit the alarm current to below 100mA or lower if the detector has a lower maximum alarm current rating. Its output voltage in alarm (to the panel) is compatible with most panels, and the ELD used (panel side) is that from the original panel. It operates directly off the 24V panel supply, and draws approximately 20mA in the normal condition. The ZAU401 monitors the voltage provided by the panel to its Zone+ input, and when this disappears during a reset operation the ZAU401 turns off the supply to its detectors – thus resetting them as well.

Wire Guard



W500 Series detector cages are available in a range of sizes to cater for most of the detectors that are available through Johnson Controls - Fire Detection. These white powder coated steel protective cages are suitable for applications where unprotected devices would be vulnerable to accidental damage.

Part Numbers

W500	120mm dia. x 80mm deep (to suit 130 Series)
W502	195mm dia. x 120mm deep
W504	130mm dia. x 105mm deep (to suit 600 and 800 Series)
W508	82mm dia. x 110 deep (suit T54B)
4098-9846	TrueAlarm Vandal Guard (not shown)
STI-8200-SS	Smoke Detector Cover, Flush Mnt 1.2mm Stainless Steel, 203mm dia. x76mm deep
STI-8230-SS	Smoke Detector Cover, Surface Mount 1.2mm Stainless Steel, 228mm dia. x127mm deep



STI-8200-SS Flush Mount Smoke Detector Guard



STI-8230-SS Surface Mount Smoke Detector Guard

The STI-8200-SS Series smoke detector cages are available in flush mount or surface mount configuration. These covers are designed to provide maximum protection for vulnerable smoke detectors, while not compromising their effective operation. Ideal for any application where food is present, as well as use in water treatment plants or correctional facilities. These are not suitable for heat detectors.

Round Remote Indicators



The E500 Mk2 range of remote indicators provide remote indication of an alarm condition on a fire detector. They are used where the fire detector is installed in an inaccessible location, and indication of alarm must be provided in an easily accessible area. For example, where the detectors are in roof spaces or cupboards, under the floor, or in hotel rooms, and indication is required in the room or corridor.

Specifications

Operating Voltage	4.5 to 26Vdc
Alarm Current (min.)	1.6mA
Alarm Current (max.)	20mA@60°C 12mA@75°C
Luminous Intensity	as per AS2362.25-2004
Relative Humidity	95% (n/cond) max.
Ambient Temp.	-10°C to +75°C

Part Numbers

E502	Fire Alarm
E521	Fire Alarm in Concealed Space
E523	Fire Alarm in Room
E524	Fire Alarm Above
E525	Fire Alarm in Duct
E526	Fire Alarm in Roof Space
E529	Fire Alarm in Cupboard



The 2098-1xxx range of remote indicators provide remote indication of an alarm condition on a detector fitted to a 4098-97xx detector base.

These remote indicators are not suitable for connection to any other MAPNET II or IDNet module.

They are used where the fire detector is installed in an inaccessible location, and indication of alarm must be provided in an easily accessible area. For example, where the detectors are in roof spaces or cupboards, under the floor, or in hotel rooms, and indication is required in the room or corridor.

Specifications

Operating Voltage	1.8Vdc Typ. (from 4098-97xx Base)
Alarm Current (min.)	1.6mA
Alarm Current (max.)	25mA@45°C 15mA@75°C
Luminous Intensity	as per AS2362.25-2004
Relative Humidity	95% (n/cond) max.
Ambient Temp.	-5°C to +75°C

Part Numbers

2098-1110	Fire Alarm in Roof Space
2098-1111	Fire Alarm in Concealed Space
2098-1112	Fire Alarm in Cupboard
2098-1113	Fire Alarm Room
2098-1114	Fire Alarm in Return Air
2098-1115	Fire Alarm in Duct
2098-1116	Blank

Rectangular Remote Indicators



The E500 Mk2 range of remote indicators provide remote indication of an alarm condition on a fire detector. They are used where the fire detector is installed in an inaccessible location, and indication of alarm must be provided in an easily accessible area. For example, where the detectors are in roof spaces or cupboards, under the floor, or in hotel rooms, and indication is required in the room or corridor.

Specifications

Operating Voltage	4.5 to 26Vdc
Alarm Current (min.)	1.6mA
Alarm Current (max.)	20mA@45°C 11mA@75°C
Luminous Intensity	as per AS2362.25-2004
Relative Humidity	95% (n/cond) max.
Ambient Temp.	-10°C to +75°C

Part Numbers

E542	Fire Alarm
E551	Fire Alarm in Concealed Space
E553	Fire Alarm in Room
E554	Fire Alarm Above
E555	Fire Alarm in Duct
E556	Fire Alarm in Roof

Latching Remote Indicators



The E500 Mk2 range of latching remote indicators provide latching remote indication of an alarm condition on a fire detector. They are used typically where a T54B probe type fire detector (or other clean-contact non-latching device) is installed (which may be in an inaccessible location), and indication of alarm must be latched and provided in an easily accessible area. For example, where the detectors are in roof spaces or cupboards, exhaust hoods etc and indication is required in the room or corridor.

Specifications

Operating Voltage	9.7 to 28Vdc
Alarm Current (min.)	5mA
Alarm Current (max.)	20mA@45°C 11mA@75°C
Luminous Intensity	as per AS2362.25-2004
Relative Humidity	10% to 95% (n/cond)
Ambient Temp.	-5°C to +75°C

Part Numbers

E561	Fire Alarm in Concealed Space
E573	Fire Alarm in Room
E574	Fire Alarm Above
E575	Fire Alarm in Duct
E566	Fire Alarm in Roof Space

Fire Panel Ancillaries

AAM2 Alarm Acknowledge Module



The AAM2 Alarm Acknowledge Module provides a facility to locally annunciate a smoke/CO detector alarm, and for the occupant to

acknowledge and clear a false fire alarm without the fire brigade being called. The AAM2 has no sounder and is used with a detector mounted in a sounder base. The AAM2 is usually installed in a single occupancy unit (apartment, flat or single-person's quarters) along with 1 or more non-latching smoke/CO fire detectors. When an alarm is detected the sounder in the detector base and the red LED in the AAM2 operate and the occupant has (typically) 30 seconds to acknowledge the alarm. This starts a further time delay (typically 1-3 minutes), during which they must clear the smoke to avoid calling the fire brigade. If either time delay elapses and smoke is still present, then the fire panel goes into alarm and the brigade is called. As standard the AAM2 comes without a face plate, these must

be ordered separately. Two different face plates are currently available:
The AAM2 is compatible with the VIGILANT MX1 and MX4428/F4000 and SIMPLEX 4100 FIPs. Refer to LT0304, AAM2 Installation Instructions.

Specifications	
Operating Voltage	2-28Vdc
Quiescent Current	0µA
LED Current	2-20mA
Operating Temp.	-5°C to +45°C
Operating Humidity	10% to 95% R.H (n/cond)
Weight (typical)	100g
Approvals	FTS-136
Time Limit	Panel Programmable



FA2317
The AAM2 can be used with the FA2317 face plate for general alarm indication, annunciation and acknowledgment, e.g., a Nurses Station. The FA2317 face plate has text labeling "Press to Acknowledge Fire Alarm". The AAM2 can be wired up to the fire panel so the LED lights on alarm and an external sounder operates as well. Pressing the button silences the buzzer and turns off the LED.

Part Number
FP0894 Alarm Acknowledge Module AAM2 complete with FA2317 Faceplate



FA2318
The AAM2 can be used with the FA2318 face plate to make an Alarm Acknowledgment Module, as FA2318 contains the additional text information and space for the investigation time to be filled in on-site. The AAM allows the resident of a Sole Occupancy Unit (SOU) or apartment to acknowledge and clear

a false fire alarm without the fire brigade being called.

Part Number
FP0895 Alarm Acknowledge Module AAM2 complete with FA2318 Faceplate



ME0420
AAM2 Alarm Acknowledge Module (no sounder for the AAM2. It is comprised of a backplate with PCB. A faceplate with the required text is added to make up an AAM2 kit. The complete AAM2 unit is ordered as either FP0894 or FP0895.

Part Number
ME0420 Alarm Acknowledge Module AAM2 no Faceplate

AAM4 Alarm Acknowledge Module



The FP0842 Alarm Acknowledge Module provides a facility to locally annunciate a smoke/CO detector alarm, and for the occupant to acknowledge and clear a false fire alarm without the fire brigade being called. The AAM4 with an inbuilt sounder is usually installed in a single occupancy unit (apartment, flat or single-person's quarters) along with 1 or more non-latching smoke/CO fire detectors. When an alarm is detected the inbuilt sounder and red LED in the AAM4 operate and the occupant has (typically) 30 seconds to acknowledge the alarm. This starts a further time delay (typically 1-3 minutes), during which they must clear the smoke to avoid calling the fire brigade. If either time delay elapses and smoke is still present, then the fire panel goes into alarm and the brigade is called. The AAM4 is compatible with the MX4428/F4000 and Simplex 4100 FIPs. Refer to LT0276, AAM4 Installation Instructions.

Specifications	
Operating Voltage	18-28Vdc
Quiescent Current	0µA
Alarm Current (max)	23mA Sounder On
Alarm Current (max)	15mA Sounder Off
Operating Temp.	-5°C to +45°C
Operating Humidity	10% to 95% R.H (n/cond)
Weight (typical)	100g
Approvals	FTS-136
Time Limit	Panel Programmable
Part Number	FP0842

PA0915 Fused Power Distribution Board



A 4-way general purpose fused distribution board is available for use with VIGILANT and SIMPLEX fire alarm equipment. This compact printed circuit board splits one supply into 4 separately fused outputs, each rated at 1A (fuses can be changed up to 5A, subject to a 16A overall load limitation). Voltage transient protection is provided across the supply and to earth via 36V tranzorbs. Earthing of the board via its mounting holes is required for this suppression to be fully effective. No fuse supervision is currently provided (may be required for compliance with AS 4428 if powered item does not supervise its power supply in some way).

Specifications	
Input	0-30Vdc, 16A max, screw terminals 4mm ²
Output	4 separate o/p, each fused at 1A (20 x 5)
Screw terminal Fuses	2.5mm ² - two sets per o/p Replaceable up to 5A each subject to maximum input current rating above
Suppression	36V bi-directional tranzorbs across supply and to earth (via mounting holes).
Dimensions	101mm x 38mm
Mounting	4 x 3.5mm dia, 89 x 25.5mm
Part Number	PA0915

PA0730 General Purpose Relay Board



The 24V PA0730 two pole changeover contact general purpose relay board may be used in either of two modes:

1) Direct Operation: The relay will operate when the rated voltage is applied to the +ve and -ve terminals.

2) SIG+ Input: Cutting link LK1 will allow the relay to operate if a positive voltage between 3.5V and 30Vdc is applied to the SIG+ terminal. SIG+ is a low current input so it may be driven by a logic level signal.

In this mode the relay board must have constant power to the + and - terminals. The relay board also provides visual feedback with an LED illuminated whenever the relay is energised.

Two sets of changeover contacts are available at screw terminals on the relay board.

Specifications	PA0730
Operating Voltage	24Vdc (±20%)
Quiescent Current	nil
Operating Current	12mA
Relay Contact	2A @ 30Vdc resistive
(per pole)	1A @ 30Vdc inductive
	1A @ 30 Vac inductive
Ambient Temp	-5°C to +45°C
Relative Humidity	0 to 95% (non/cond)
Dimensions (mm)	40 x 41
Weight	0.05kg
FPANZ Listed	VF/662
Part Number	PA0730

LED Display Extender Modules

Additional LED Display - 7U Door

Increasing the number of LED zone displays on either an F3200 or MX4428 requires 1 x ME0060 plus 1 x FZ3031 plus up to 3 x FP0475 (as required). The 7U Display Door mounts directly below the standard 4U LCD. The Zone LEDs are Alarm (Red); Fault (Yellow); Isolated (Yellow) with a Zone name space of 10mm x 60mm per zone on a paper label; eg. 2 lines of 23 characters at 10 per inch.

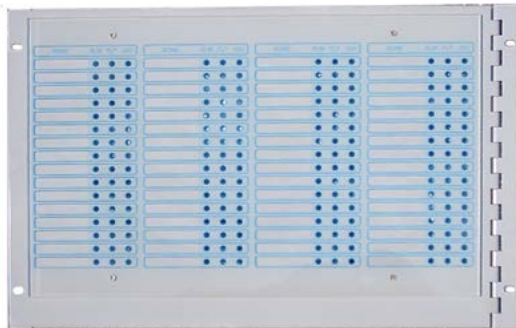

ME0060 7U Inner Display Door

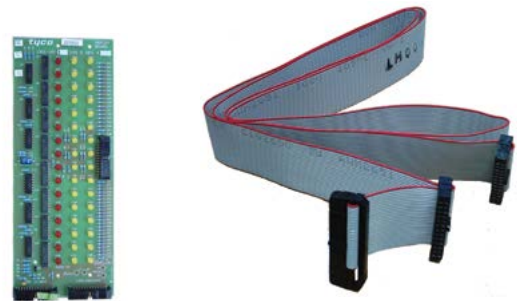

FP0475 Display Extender Kit includes: PA0454 16Z Display PCB, LM0046, standoffs, power leads, diffuser, Zone name label master. **LM0092** Loom FRC 26W Kybd to First Display 1.1m shown.

Additional LED Display - 4U Door

Increasing the number of LED zone displays on either an MX1 F3200 or MX4428 requires 1 x ME0457 plus 1 x FP1002 plus up to 4 x FP1002 (as required.) The 4U Display Door mounts directly below the standard 4U LCD. The Zone LEDs are Alarm (Red) and Isolate/Disable (Yellow). A Zone name space of 9mm x 44mm per zone on a paper label; e.g. 1 line of 12 characters at 5mm high (23 characters at 3mm high).



ME0457 4U Inner Display Door



FP1002 16Z Display PCB



LM0339 Loom FRC 26W Kybd to 1st Disp, 200 mm

Table 1. Cables Required for 4U LED Display Door

	F3200/ NDU/ NLDU	MX4428	MX1
Controller to highest numbered LED Display Board	LM0092	LM0295 or LM0056	LM0092 or LM0339*
Controller connector	J13 on Controller Board	J6 on Main Board	J2 on LCD/Keyboard
Connect additional 4U LED Display Door	LM0056	LM0056	LM0056 or LM0291*
Inter-connect LED Display Boards	LM0291	LM0291	LM0291*

* LM0291 and LM0339 are included with FP1002

Table 2. LED Display Module Comparison

	FP1002	FP0475
Dimensions	144 x 52 mm	250 x 97 mm
Electrical	Electrically identical; FP1002 uses 1/3 of the power	
End-of-Chain link	Not Required	Required
Separate Fault LED	No	Yes
External Output	No	Yes

Part Numbers

FP0475 Display Extender Kit (includes PA0454, LM0046, standoffs, power leads, diffuser, Zone name label master)

FP1002 4U 16 Zone LED Display PCB (includes PCB, LM0291 FRC, LM0339 FRC, mounting hardware)

FZ3031 Display Extender Kit (includes FP0475, LM0092 in lieu of LM0046) - use as first (LHS) display

ME0060 7U Inner Display Door 1901-75 (includes M6 fasteners). It mounts up to 4x 16 Zone LED display boards.

PA0454 7U 16 Zone LED Display PCB

ME0457 4U Inner Display Door mounts up to 5x FP1002 LED Display Boards

LM0044 FRC 26W Style B 200mm

LM0045 FRC 26W Style B 5000mm

LM0046 FRC 26W Style B 500mm

LM0049 FRC 26W Style B 250mm

LM0056 FRC 26W Style B, 1400 mm

LM0092 FRC 26W Kybd to 1st Disp, 1100 mm

LM0291 FRC 26W Style B, 230 mm

LM0295 FRC 26W Style B, 700 mm

LM0339 FRC 26W Kybd to 1st Disp, 200 mm

VIGILANT 19inch Rack Cabinet Range

Cabinets and Cabinet Accessories



FP0576 Empty Battery Box
Dimensions 440x550x211mm (HWD)
Battery Capacity 2x80Ah / 6x40Ah



FP0556 MX4428/F3200 15U Cabinet only
Dimensions 750x550x211mm (HWD)



FZ9028 3U WA/Cube ASE Bracket & Loom



FP0935 4U ASE Bracket & Loom



FP0937 4U WA/Cube ASE Bracket & Loom

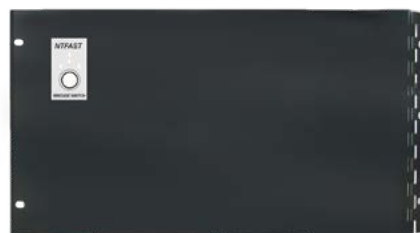

FP1093 6U NT Brigade Bracket & Loom - Simplex



ME0268 21U (Cabinet only)
Dimensions 1050x575x310mm (HWD)

ME0351 21U (Cabinet only with QE90 Module Mounting Studs)



SW0018 3 Position keyswitch - incl. 003 keys



HW0040 Cam-Lock - includes 003 keys
HW0226 Key only - 003 style

Flush Surrounds (cream wrinkle)

FA1299	Flush Surround for 8U Cabinet
FA1235	Flush Surround for 15U Cabinet
FA1929	Flush Surround for 18U Cabinet
FA2031	Flush Surround for 21U Cabinet
FA1930	Flush Surround for 28U Cabinet
FA1931	Flush Surround for 40U Cabinet

Blank Panels (include 19" rack fixing hardware)

FZ9002	7U Blank Hinged Inner Door (312mm)
FZ9003	6U Blank Panel Acrylic (266mm)
FZ9004	4U Blank Panel (178mm)
FZ9005	3U Blank Panel (134mm)
FZ9006	2U Blank Panel (89mm)
FZ9007	1U Blank Panel (45mm)
FZ9015	5U Blank Panel (223mm)
FZ9016	6U Blank Panel (267mm)
FA1227	9.5U Blank Panel (420mm)
FA1852	QE90 6U Smoked Perspex (266mm)
FA2017	QE90 5.5U Blank Plate (244mm)
FA2376	4100U 9U Display Trim

Gear Plates

FA1185	1901-47, F4000 Std 450x460
FA2040	1901-193, F4k Rack Basic 540x460
FA1984	1901-190, F4k 18U 770x482x180
FA1983	1901-189, F4k 18U S'less 770x483
FA1199	1901-101, F4k Large 1200x483x180
FA1366	1901-181, S'less, Large 1200x483
FA1267	1931-69, F3200 Std 480x460
FA1846	699-053, QE90 480x489x175 *
FA1833	699-052, QE90 Std 729x489x175 **
FA2019	699-232, QE90 SECP Batt Brkt

* To suit cabinet ≥ 18U

** To suit cabinet ≥ 28U

Cabinets

FP0556	F3200, Empty Cab, c/w window
FP0557	F3200, Empty Cab, c/w blank door
FP0576	F3200, Battery Box
FP0584	F3200, Small Empty Cab, full window
FP1030	MX1 15U Empty Cab c/w wndw Titania
FP1084	MX1 15U Empty Cab wndw Tit.,no MCP
ME0250	20Ux200 IP65 990x630x260 (HWD)
ME0341	Rack Cab, 20Ux310 IP65
ME0260	Rack Cab, 20Ux310, 304 S/S IP65
ME0270	Rack Cab, 30Ux310 IP65
ME0280	Rack Cab, 40Ux310 IP65
ME0252	Rack Cab, 18U 135, Full Wndw
ME0253	Rack Cab, 18U 310, Full Wndw
ME0268	Rack Cab, 21U 310, Full Wndw
ME0254	Rack Cab, 28U 135, Full Wndw
ME0255	Rack Cab, 28U 310, Full Wndw
ME0256	Rack Cab, 40U 135, Full Wndw
ME0257	Rack Cab, 40U 310, Full Wndw
ME0262	Rack Cab, 18U 135, Blank Door
ME0263	Rack Cab, 18U 310, Blank Door
ME0269	Rack Cab, 21U 310, Blank Door
ME0264	Rack Cab, 28U 135, Blank Door
ME0265	Rack Cab, 28U 310, Blank Door
ME0266	Rack Cab, 40U 135, Blank Door
ME0267	Rack Cab, 40U 310, Blank Door
ME0088	IOR Cabinet 449x494x82mm (HWD)
ME0251	Small QE90, 21U 310, Full Wndw, Crm
ME0261	Small QE90, 21U310, Blank, Cream

Cabinet Doors

FA1262	Outer Door, Blank 8U
ME0336	Outer Door Full Window 15U
FA1218	Outer Door Perspex 15U
FA1228	Outer Door Blank 15U
ME0273	Outer Door Full Window 21U
ME0283	Outer Door Blank 21U
ME0274	Outer Door Full Window 28U
ME0276S	Outer Door Full Window 40U
ME0286	Outer Door Blank 40U
FA2113	Outer Door Perspex 40U

Standard Cabinet Sizes

Part No	Units	Dimension
FP0584	8U	440x550x211
FP0556	15U	750x550x211
ME0252	18U	885x575x205 (135 Deep)
ME0253	18U	885x575x380 (310 Deep)
ME0268	21U	1050x575x312 (310 Deep)
ME0254	28U	1330x575x165 (135 Deep)
ME0255	28U	1330x575x340 (310 Deep)
ME0256	40U	1865x575x165 (135 Deep)
ME0257	40U	1865x575x310 (310 Deep)

Special Cabinet Sizes

ME0250	20U	IP65 990x630x260 (200 Dp)
ME0260	20U	S/S IP65 990x630x370 (310 Dp)
ME0341	20U	IP65 990x630x370 (310 Dp)
ME0270	30U	IP65 1435x630x370 (310 Dp)
ME0280	40U	IP65 1879x630x370 (310 Dp)

Accessories

HW0202	Block, Hinge Set 6mm
KT0199	3U Centaur ASE Bracket
KT0212	3U 2xV-Modem/ASE Door
KT0419	Kit, Document Holder Stick On 3U
FP0935	4U ASE Door Kit 4100ES-S1
FP0937	4U WA/Cube ASE Door Kit 4100ES-S1
FP1092	6U NT Brigade Door Kit Vigilant grey
FP1093	6U NT Brigade Door Kit Simplex black
FZ9037	7U Hinged Door with Document Holder
FZ9028	3U WA/Cube ASE Bracket & Loom
ME0258	1919-21-2 Rack Cab 1U Shelf 135 DP
ME0259	1919-21-1 Rack Cab 1U Shelf 310 DP
ME0512K	4100ESi Cube ASE & Mic kit (uses 6 slots of a 7U display door - black)
ME0513K	4100ESi Centaur11 ASE & Mic kit (uses 6 slots of a 7U display door (black))
NT0030	Nut, Cage M6 Zinc Plated
SC0058	Screw, Machine Pan/Pozi M6x12 ZP
WA0008	Washer Flat M6 12mm ODx1.2mm Thk

Cabinet Size Table

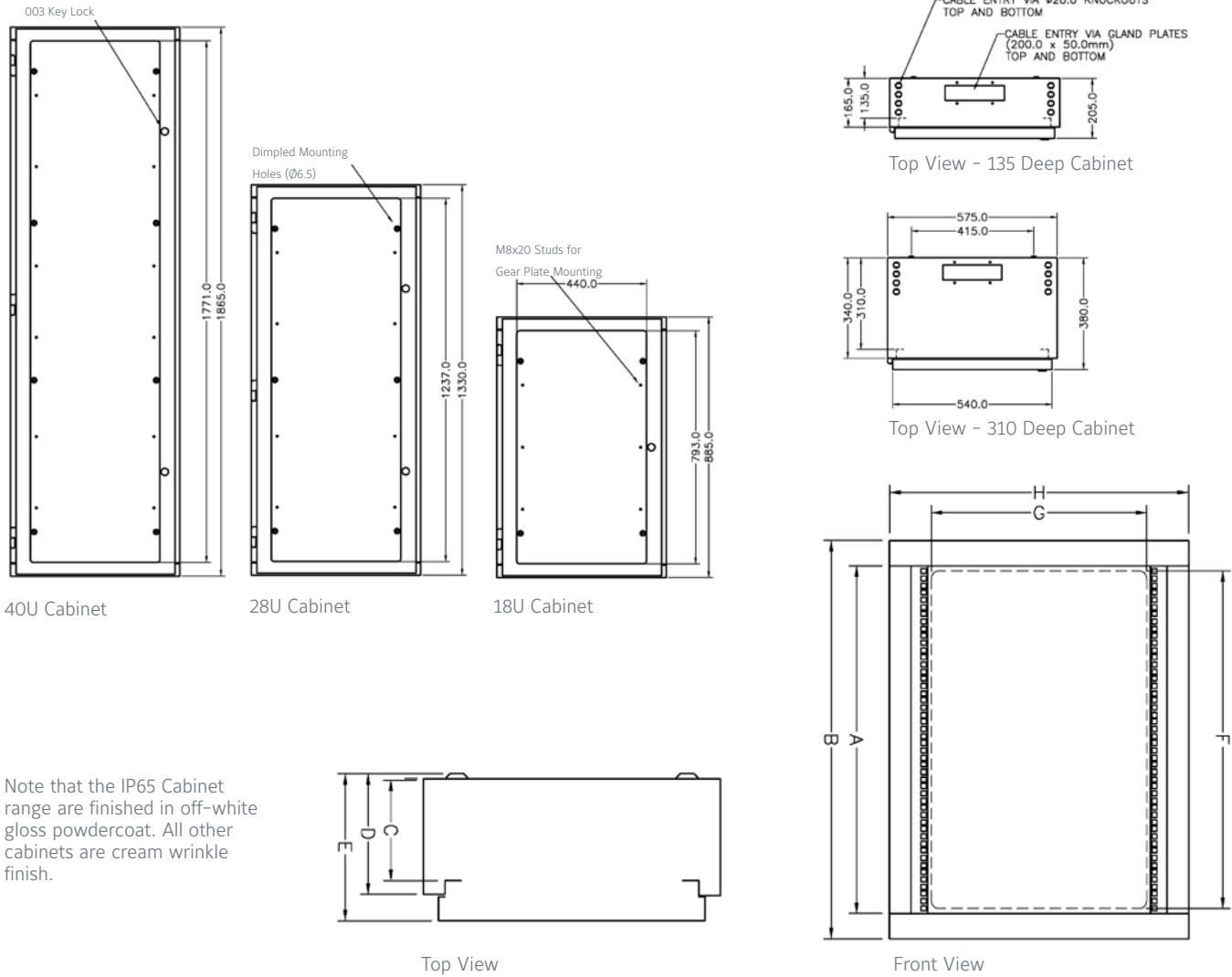

Note that the IP65 Cabinet range are finished in off-white gloss powdercoat. All other cabinets are cream wrinkle finish.

CAPACITY A	F3200 8U IP30	F3200 15U IP30	20U IP65 200 Deep	20U IP65 310 Deep	30U IP65 310 Deep	40U IP65 310 Deep	18U 135 Deep IP30	18U 310 Deep IP30	21U 310 Deep IP30	28U 135 Deep IP30	28U 310 Deep IP30	40U 135 Deep IP30	40U 310 Deep IP30
CABINET PART No	FP0584	FP0556	ME0250	ME0260 (SS) ME0341	ME0270	ME0280	ME0252	ME0253	ME0268	ME0254	ME0255	ME0256	ME0257
Blank Door Cabinet	FP0576	FP0557	-	-	-	-	ME0262	ME0263	ME0269	ME0264	ME0265	ME0266	ME0267
B Overall Height (mm)	440	750	990	990	1435	1879	885	885	1050	1330	1330	1865	1865
C Internal Depth (mm)	177	177	196	306	306	306	135	310	310	135	310	135	310
D Cabinet Depth (mm)	183	183	200	310	310	310	165	340	312	165	340	165	340
E Overall Depth (mm)	211	211	260	370	370	370	205	380	355	205	380	205	380
F Window Height (mm)	222	575	796	796	1241	1740	793	793	940	1237	1237	1771	1771
G Window Width (mm)	431	431	435	435	435	435	440	440	440	440	440	440	440
H Cabinet Width (mm)	550	550	630	630	630	630	575	575	575	575	575	575	575
Window Material	Acrylic	Acrylic	Glass	Glass	Glass	Glass	Acrylic	Acrylic	Acrylic	Acrylic	Acrylic	Acrylic	Acrylic

Note: "DEEP" in description refers to Internal Depth (dimension "C" above)

Gear Plate Utilisation (examples)

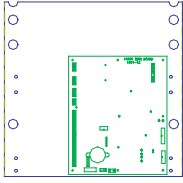

MX4428 Main Board Mounting

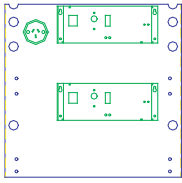

MX4428 6A PSU Brick Mounting

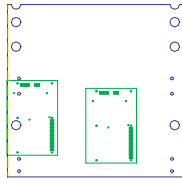

ADR/MPR Mounting

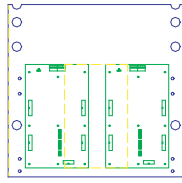

IOR Mounting

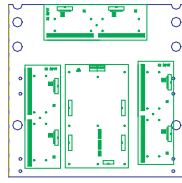

IOR & Termination Board Mounting

FA1185 MX4428 Standard Gear Plate

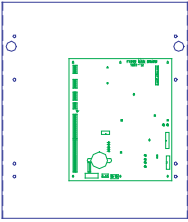

MX4428 Main Board Mounting

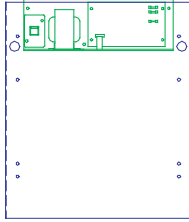

MX4428 5A PSU Mounting

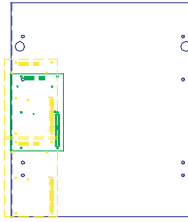

ADR/MPR Mounting

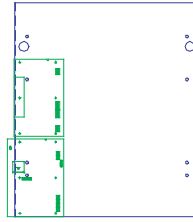

T-GEN 50 & MXP Mounting

FA2040 MX4428 Basic Gear Plate

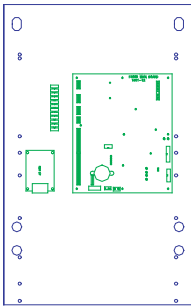

MX4428 Main Board Mounting

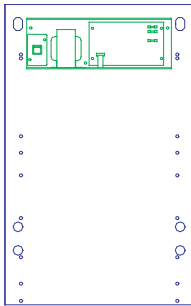

MX4428 5A PSU Mounting

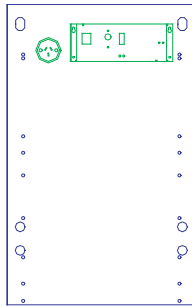

MX4428 6A PSU Brick Mounting

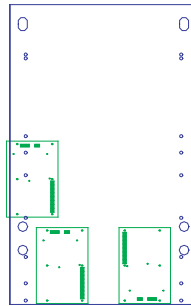

ADR/MPR Mounting

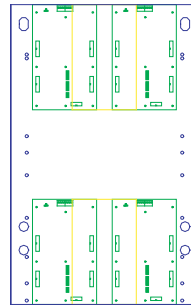

IOR Mounting

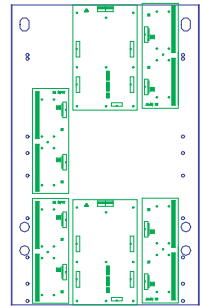

IOR & Termination Board Mounting

FA1983 MX4428 18U Sideless Gear Plate

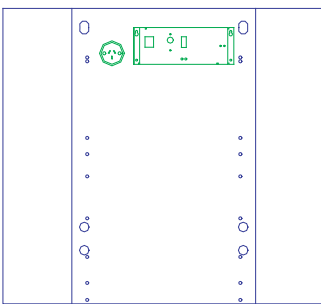

MX4428 6A PSU Brick Mounting

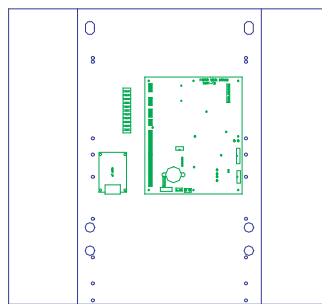

MX4428 Main Board and RZDU/RS232 I/F Board Mounting

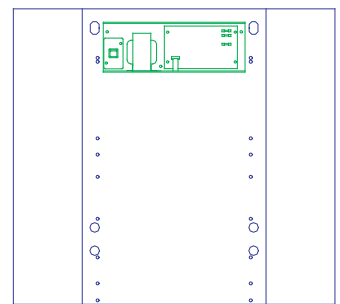

MX4428 5A PSU Mounting

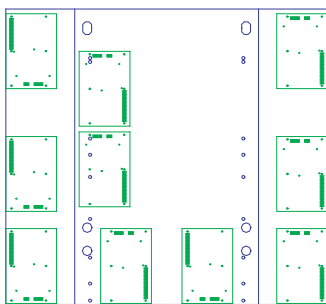

ADR/MPR Mounting

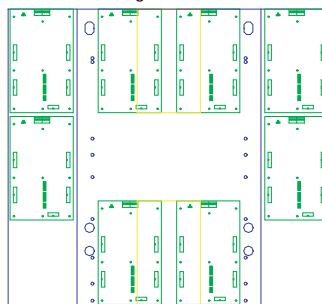

IOR Mounting

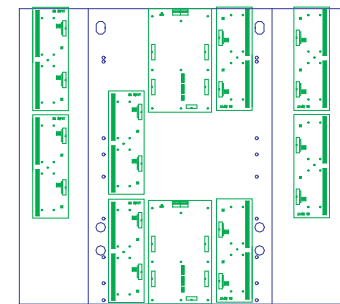

IOR & Termination Board Mounting

FA1984 MX4428 18U Sided Gear Plate

Gear Plate Utilisation (examples)

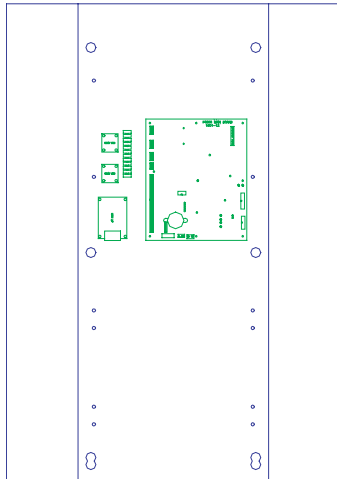

MX4428 Main Board and RZDU/RS232 I/F Board Mounting

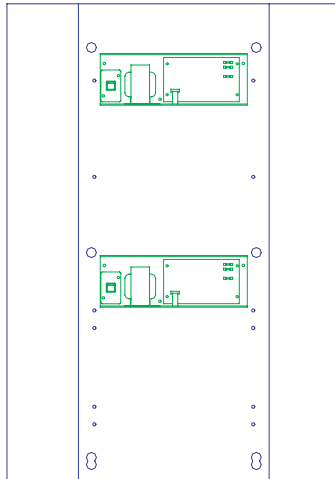

MX4428 5A PSU Mounting

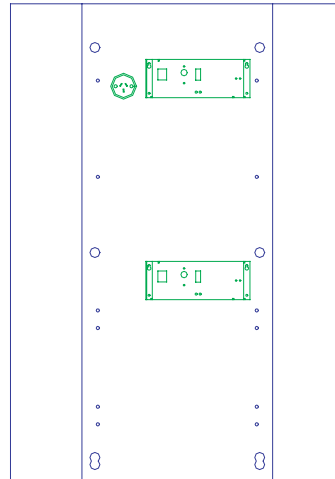

MX4428 6A PSU Brick Mounting



ADR/MPR Mounting

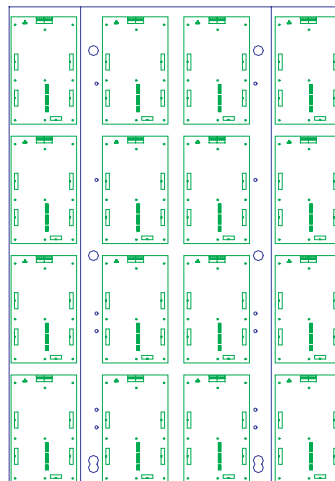

IOR Mounting

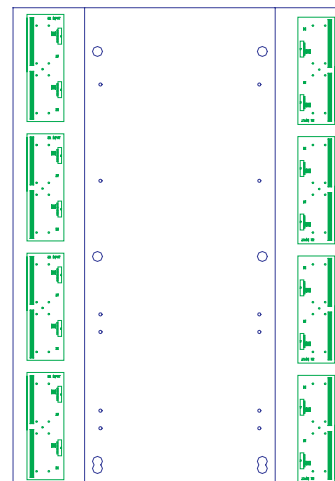

IOR Termination Board Mounting

FA1199 MX4428 28U Sided Gear Plate

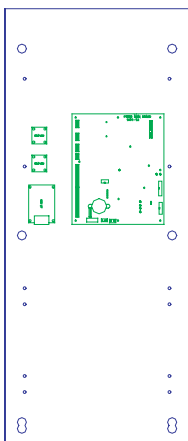

MX4428 Main Board and RZDU/RS232 I/F Board Mounting

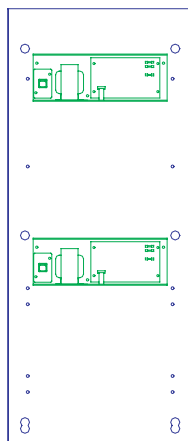

MX4428 5A PSU Mounting

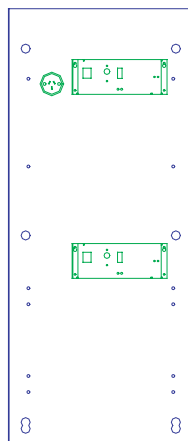

MX4428 6A PSU Brick Mounting

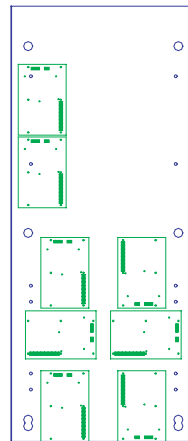

ADR/MPR Mounting

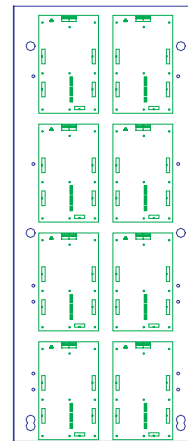

IOR Mounting

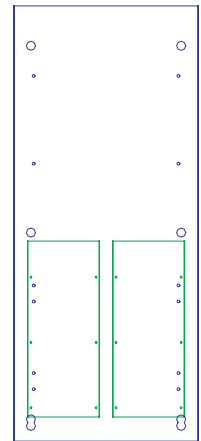

F3200 Card Frame Mounting

FA1366 MX4428 28U Sideless Gear Plate

Looms and Cables

Looms and Cables



LM0041 MX4428/F4000 Cable Programming Port to DB9F serial 1888-58
LM0042 MX4428/F4000 Cable Programming Port to DB25F serial 1888-62



LM0065 RS-485 Comms 10W FRC to DB9

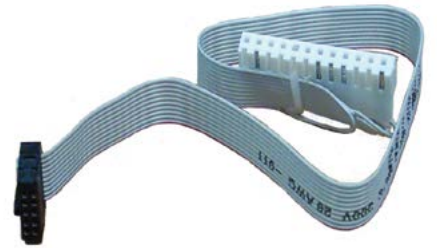

LM0185 MX4428 Molex to CMOS/RS-232 1901-214



LM0047 Loom FRC 26W Style D 1.3m QE90 TRAN8872



LM0076 Programming DB9F to DB9F Null Modem (MX1, QE90 ECM, ADU)



LM0195 4100 MAPNET Power Harness



LM0049 Loom FRC 26W Style B 0.25m

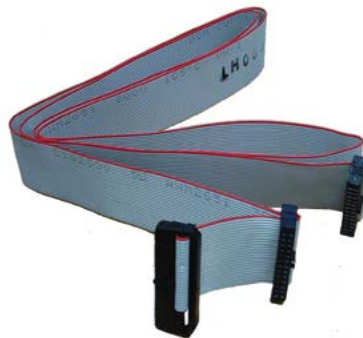

LM0092 Loom FRC 26W F3200 MkII Controller to First Display 1.1m



LM0339 Loom FRC 26W, MX1 Keyboard to First Display, 200 mm



LM0053 Loom FRC 20W Style A 0.3m



733-794 4100 Download Port Cable 10W FRC to DB9

Loom Style Types (VIGILANT range)

- Notes
1. The loom style connector types, cable cut length and cable style are specified in the loom description.
 2. The cut length for a flat ribbon cable (FRC) will generally be 'Finished Length'.
 3. Both 'Bump Polarised' sockets and 'Transition' connectors are illustrated. Looms can have combinations of these connectors.

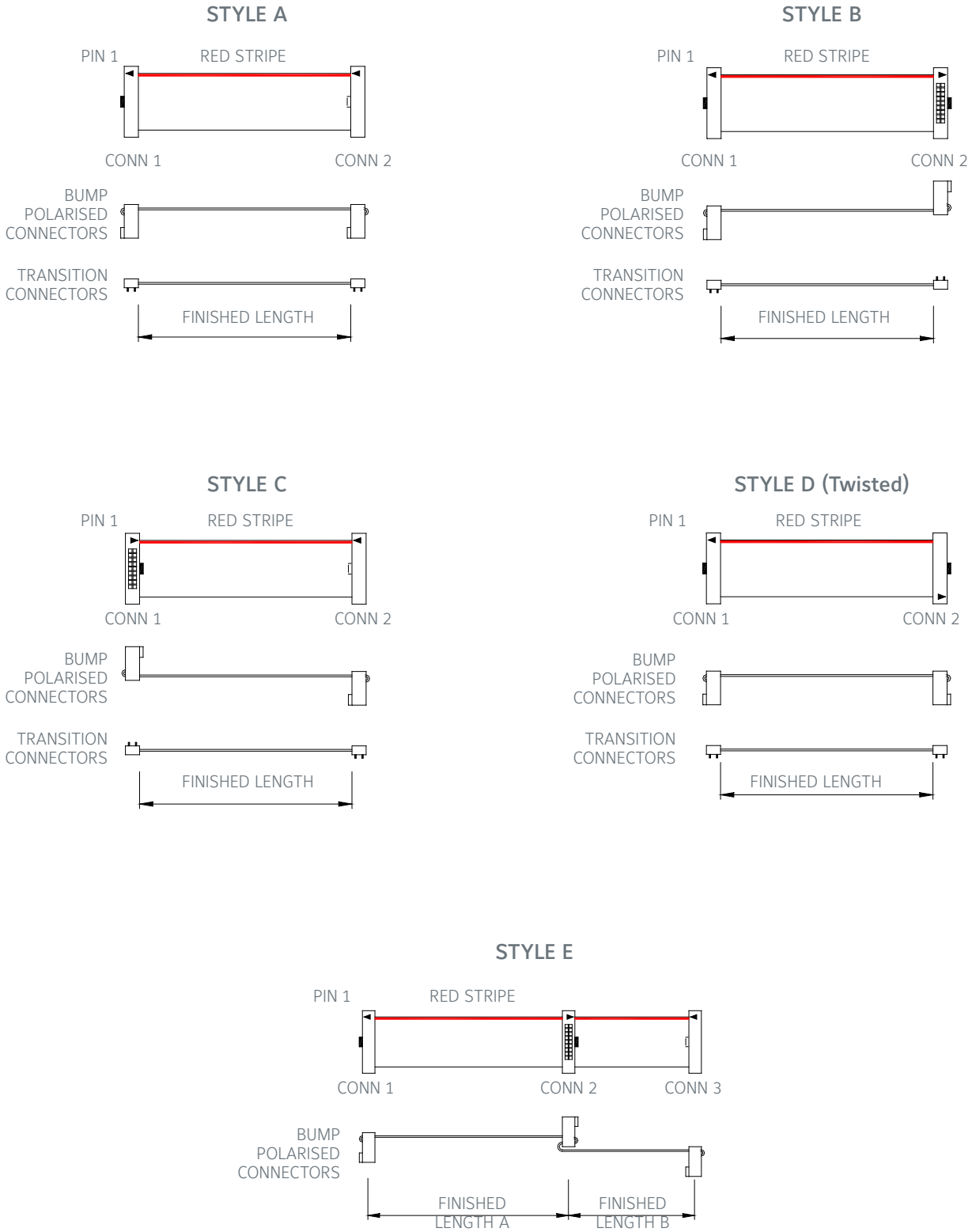

Fire Detection Product Catalogue

Looms and Cables

ITEM CODE	EXTENDED DESCRIPTION	APPLICATION
LM0061	LOOM 1830-43 1830 MODEM TO 16 WAY FRC & DB25 PLUG	1830 MODEM
4100-KT0490K	4100ES XSPS POWER SUPPLY LOOM & HARNESS KIT	4100ES
733-794	4100 DOWNLOAD PORT CABLE	4100ES
LM0192	MAINS LEAD 4100-0157A	4100ES
LM0194	LOOM 4100 DOOR SWITCH LOOM & ASSY 003-018	4100ES
LM0195	LOOM MAPNET POWER HARNESS	4100ES
LM0223	BATTERY LEAD SET 4100-0157AK	4100ES
LM0288	LOOM ASE CNI-403ME SIGNAL CABLE 1963-80	ASE
LM0293	LOOM ASE G18 RADIO MODEM RF CABLE	ASE
LM0053	LOOM FRC 20W STYLE A 0.3m (8 Relay Module to 8 Zone Module)	F3200
LM0083	LOOM FRC 20W STYLE C, 0.7m (MAF/PSU to 8 Zone Module)	F3200, MX4428 Keyboard to Mainboard
LM0118	LOOM FRC 26W STYLE B, 0.6m (MAF/PSU to Controller)	F3200
LM0092	LOOM FRC 26W STYLE E F3200 MKII CTL TO 1ST DISP 1931-88 1.1m	F3200
LM0103	LOOM F3200 MCP+MICRO SWT LOOM 1931-97	F3200
LM0152	LOOM FRC 10W ECM/F3200 NETWORK X-OVER 0.7m	F3200/MX4428/I-HUB [MX4428 > Iss C]
LM0076	LOOM ADU PROG DB9F - DB9F 1922-25	ADU/MX1
LM0339	LOOM FRC 26W MX1 CTL TO 1ST DISP 0.22m	MX1
LM0104	LOOM F4000 MCP + MICRO SWT LOOM 1901-196	MX4428/F4000
LM0107	LOOM FRC 16W STYLE C 0.7m (LCD to Main Board)	MX4428/F4000
LM0151	LOOM FRC 10W to MOLEX MX4428 RING NET UPGRADE X-OVER 1901-201 1.1m	F4000/I-HUB [F4000 < Iss C]
LM0172	LOOM FRC 10W STYLE A 0.25m (PSU to Main Bd, also Main Bd to Network bd)	MX4428/F4000/MX1 Ctrlr-PA0773
LM0185	LOOM F4000 MOLEX TO CMOS/RS232 1901-214	F4000
LM0043	LOOM QE90 EXTENDER 699-090-1 FRC 20W 0.07m	QE90
LM0047	LOOM QE90 TRANSFORMER MODULE TWISTED FRC 26W STYLE D 1.3m	QE90 TX Module
LM0048	LOOM FRC 20W STYLE B 0.25m (ECP Interconnect)	QE90
LM0060	LOOM FRC 34W STYLE B 1.2m (ECP to SPIF/SE9004 board)	QE90
LM0063	LOOM 699-228 QE90 ECP POWER LOOM UP TO 21U (with 6-way Connector CN0256)	QE90
LM0065	LOOM 1901-174 RS485 COMMS BD (also ECM) 10 W FRC TO DB9 CABLE	QE90
LM0076	LOOM ECM PROG DB9F - DB9F 1922-25 Null Modem (crossover)	QE90/ADU/I-HUB/MX1
LM0077	LOOM 1922-26 RZDU RS232-ECP HIGH LEVEL LINK 2.9m	QE90
LM0078	LOOM 1922-27 RZDU RS232-ECM HIGH LEVEL LINK 3m	QE90
LM0098	LOOM FRC 34W STYLE B 0.8m (WTRM board to WIPS board)	QE90
LM0100	LOOM 699-087 FRC,34W 1.5m	QE90
LM0101	LOOM QE90 FRC 26W STYLE E 0.45m + 0.9m QE90	QE90 Backplane-SPIF
LM0138	LOOM DB9M-DB9F PINS STRAIGHT THROUGH 1.8m (non-ECM prog. cable)	QE90 ECP
LM0141	LOOM QE90 AMP200 INTERCONNECT LOOM 150mm 699-253	QE90
LM0077	LOOM RZDU RS232 ECP H/LVL LNK 1922-26 1m	RZDU
LM0078	LOOM RZDU RS232 ECM H/LVL LNK 1922-27 3m	RZDU
LM0164	LOOM V-MODEM RJ45-DB25 MALE PLU 1963-55	V-MODEM
LM0165	LOOM V-MODEM PRG LD LM0164-DB9F 1963-55	V-MODEM
LM0166	LOOM V-MODEM RJ45-DB9 FEM PLUG 1963-55	V-MODEM
LM0168	LOOM V-MODEM DB9M TO 4W MOLEX 1963-55	V-MODEM
LM0041	LOOM F3200/F4000/FP4000/MX4428 PROG TO DB9F SERIAL 1888-58	F3200/F4000/MX4428
LM0042	LOOM F3200/F4000/FP4000/MX4428 PROG TO DB25F SERIAL 1888-62	F3200/F4000/MX4428
LM0061	RZDU/RS232 FRC incl with PA0481	
LM0065	LOOM RS485 COMMS BD FRC 10W - DB9 1901-174	
LM0131	LOOM SERIAL PRINTER CABLE DB9(M) TO DB9(M) + DB9(F)	
LM0161	LOOM FRC 10W STYLE A 0.1m	
LM0172	LOOM FRC 10W STYLE A 0.25m	
LM0084	LOOM FRC 10W STYLE B 0.35m	
LM0093	LOOM FRC 10W STYLE C 0.25m	
LM0091	LOOM FRC 10W STYLE C 0.5m	F3200 Network
LM0193	LOOM FRC 14W STYLE A 0.45m	
LM0107	LOOM FRC 16W STYLE C 0.7m	
LM0053	LOOM FRC 20W STYLE A 0.3m	
LM0048	LOOM FRC 20W STYLE B 0.25m	
LM0072	LOOM FRC 20W STYLE C 0.35m	
LM0083	LOOM FRC 20W STYLE C 0.7m	
LM0073	LOOM FRC 20W STYLE C 1.45m	
LM0145	LOOM FRC 26W STYLE D 0.6m	QE90
LM0146	LOOM FRC 26W STYLE D 1.1m	QE90
LM0291	LOOM FRC 26W STYLE B 0.27m	MX1/F3200/MX4428
LM0049	LOOM FRC 26W STYLE B 0.25m	
LM0046	LOOM FRC 26W STYLE B 0.5m	F3200 8Z MAF to Controller
LM0118	LOOM FRC 25W STYLE B 0.6m	F3200
LM0295	LOOM FRC 26W STYLE B 0.8m	
LM0056	LOOM FRC 26W STYLE B 1.4m	MX1/F3200/MX4428
LM0044	LOOM FRC 26W STYLE B 2.0m	
LM0045	LOOM FRC 26W STYLE B 5.0m	
LM0098	LOOM FRC 34W STYLE B 0.8m	QE90
LM0142	LOOM FRC 34W STYLE B 1.0m	
LM0060	LOOM FRC 34W STYLE B 1.2m	
LM0143	LOOM FRC 34W STYLE B 1.7m	
LM0441	LOOM FRC 10W STYLE A 0.75m	MX1 RFBP-PA0773

AS1668 Controls and Gas Controls

AS1668 Control Module Kits

MX1

The FP1056 MX1 Fan Control Door Kit includes a 3U door fitted with 2 fan controls and a label set with sample common fan control labels. Each door can accommodate up to 12 fan controls using additional FP1057 Fan Control Expansion kits.

This fan control solution has been assessed to the functional requirements of AS 7240.2-2004 and AS 4428.7-1999. It can provide up to 126 controls per MX1, by utilising FP1056 3U doors for each set of 12 controls.

It features push buttons and LED indication for On/Off/Auto, with LED status indication for Run, Stop, Fault and Alarm.

The controls can also provide convenient general purpose switches and indicators for ancillary functions such as drain valves, deluge control, and test switches. Each control can be configured to operate as a 3-position switch, 2-position switch, or 3-independant toggle or momentary switches.

The control functions can be replicated across multiple MX1 panels on a network almost instantly. The panels work in parallel, with user control available at each panel.

Additional Fan Control doors are interconnected using cables supplied. Up to 3 doors (36 controls) can be fitted in a 15U MX1 cabinet, with additional 15U or larger 28U or 40U cabinets available for more controls.

The controls are easily configured for an MX1 using SmartConfig version 2.5.1 or above. This includes logic blocks to insert pre-defined AS 1668 smoke control functions. Labels for each control can be printed using SmartConfig. The fan controls can be added to existing MX1 systems by updating to MX1 firmware version 1.60 or above.

This MX1 AS 1668 solution is not compatible with MX4428.

Part Numbers

- FP1056 MX1 3U 12x AS 1668 Controls (MX1 only)
- FP1057 MX1 2-Way AS 1668 Control Expansion Kit
- FP1084 MX1 15U Full Window Empty Cabinet, Titania
- LB0672 AS 1668 Fan Control Zone Label Set



FP1056 3U Panel with 12x AS1668 Fan Controls (MX1 only)

MX4428

The AS 1668 modules/kits consist of small PCBs that are fitted with the required components for several different AS 1668 control and indication configurations.

A three position rotary switch gives control of the appropriate fan, by selection of OFF, AUTO, or ON (from left to right). Three LEDs give indication of STOP, FAULT, and RUN conditions. These are coloured green, yellow, and red respectively.

For maximum flexibility, a number of common AS 1668 type control circuits can be achieved by using KTO113 module using different wiring configurations, and/or by minimal PCB modification (i.e. the cutting of two components).

While the kits were primarily developed to simplify factory assembly of custom panels with AS 1668 controls, they are available to purchase for fitting to panels in the field.

Refer to the Product Bulletins PBG0015C and PBG0145C and manuals LTO159, LTO368 and LTO438 for further information regarding AS 1668 kits.

Part Numbers

- FZ9011 7U Door 19" Rack, 5 x AS 1668 Controls
- FZ9012 7U Door 19" Rack, 15 x AS 1668 Controls
- FZ9036 2U Door 19" Rack, 5 x AS 1668 Controls
- KTO113 Kit, 1945-1-3 AS 1668 Control Module Type 3
- KTO512 Kit, 4 x AS 1668 + Common Master Control Module
- KTO478 Kit, AS 1668 5 way Fan Control Module

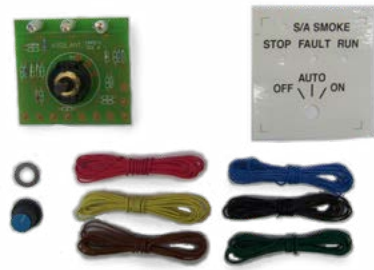

KTO113 Kit, AS 1668 Control Module Type 3



KTO478 Kit, AS 1668 5 way Fan Control Module Includes PCB, 5x switch knobs and caps, 5x panel labels, 2x 26W FRC 2m cables, LTO368 instructions

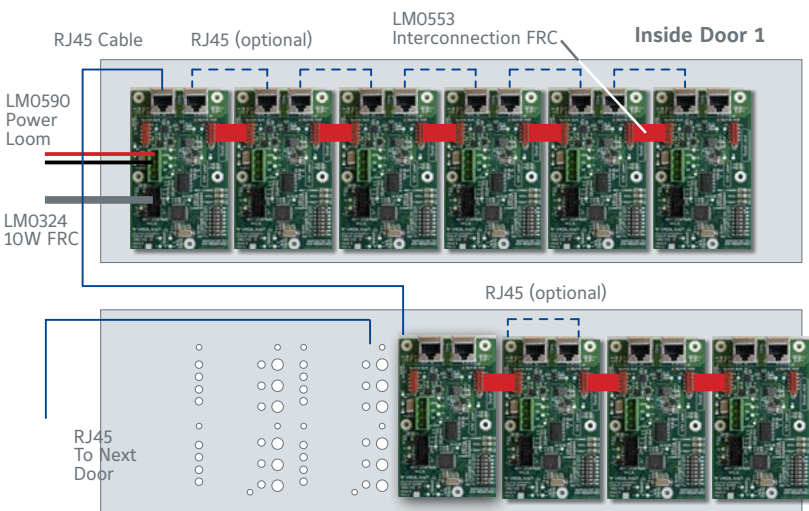

Inside Door 2



FZ9012 7U Panel with 15 AS 1668 Fan Controls Drilled

Gas Control Modules



ME0440 3 Zone Gas Flood 7U Door and Loom

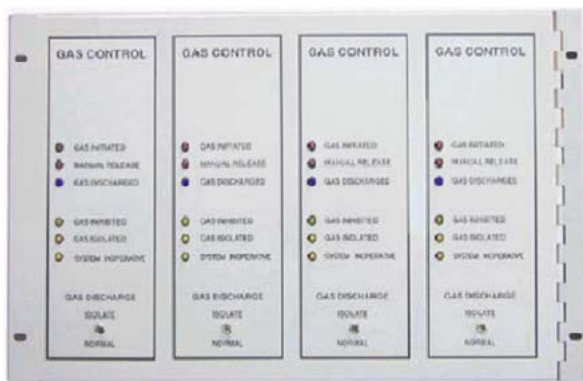

ME0441 4 Zone Gas Flood 7U Door



ME0442 1 Zone Gas Flood 1U Door and Loom



FP0570 Local Gas Control Station - Automatic. Local Gas Control Stations (LGCS) are used in gaseous fire extinguishing systems to provide local area manual control of a release. The automatic version includes a Gas Inhibit switch, buzzer and LED, whereas the manual version (FP0572) does not. The LGCS is fitted with a resettable no-break plastic frangible element.

FP1138 MX Addressable Local Gas Control Station - Automatic. Similar to FP0570, but with MX connectivity, for use with MX1.

Gas Control Modules provide indication and control of 1-4 zones of gas extinguishing on F3200 and MX4428 CIE. They are pre-wired modules (requiring appropriate input/output modules). The modules have a 12 way screw terminal block for easy termination of the field wiring for the Local Gas Control Stations, gas discharged pressure switch, warning signs and gas release output. The connection for the Alert/Evacuate warning signs is a 2-wire polarity switched output that supports up to 10 AVI Mk2 units. All outputs can be supervised (this requires appropriate programming and configuring in the panel). The gas control modules provide LEDs for each gas zone to indicate:

- Gas Initiated (red)
- Manual Release (red)
- Gas Discharged (blue)
- Gas Inhibited (yellow)
- Gas Isolated (yellow)
- System Inoperative (yellow)

A Gas Discharge Isolate switch that physically isolates both poles of the gas release actuator output is also provided for each gas zone.

Specifications

Dimensions (mm)

FP0570/2	192 x 124 x 82 (HWD)
ME043x	7U - 485 x 312 (WH)
ME0442	1U - 485 x 45 (WH)

Part Numbers

FP0570	1937-3-1 Local Gas Control Station - Auto
FP0572	1937-3-2 Local Gas Control Station - Manual
ME0439	2 Zone Gas Flood 7U Door & Loom
ME0440	3 Zone Gas Flood 7U Door & Loom
ME0441	4 Zone Gas Flood 7U Door & Loom
ME0442	1 Zone Gas Flood 1U Door & Loom
SW0122	Switch Toggle, LGCS, Locking
FP1138	MX Addressable LGCS

VIGILANT Remote Annunciators

Compact Firefighter Facility



The Compact Firefighter Facility (FF) is a compact fire alarm repeater panel for use as a remote brigade access point to a networked fire alarm system. It provides an AS4428.1 compliant alphanumeric display of alarm information on a 2 line by 40 character LCD with a simple keypad. It is compatible with the Panel-Link Networked fire alarm systems, e.g. MX4428 and F3200, and VIGILANT RZDU panels MX4428, F3200 and FP1600 and Sigma 5. The Compact FF is able to display alarms and selectively control fire alarm panels connected, and this may be modified by programming to achieve a variety of display and control facilities.

Specifications

Operating Voltage	9.6 to 28.8Vdc
Current (maximum)	380mA @ 9.6V 180mA @ 27V
Network I/F	RS-485 (Panel-Link)
Programming I/F	DB-9 male RS232
Rating	IP41
Cabinet (surface)	250x150x50mm HWD
(flush)	301x192x75mm HWD
Weight	2.5kg

Part Numbers

FP0865	Compact FF surface mount
FP0866	Compact FF flush mount
LM0076	DB9F-DB9F prog. cable

Nurse Station Annunciator



The Nurse Station Annunciator (NSA) is a compact fire alarm repeater panel for use by non-technical staff. It provides alphanumeric display of alarm information on a 2 line by 40 character LCD with a simple keypad. It is compatible with the Panel-Link Networked fire alarm systems, eg., MX4428 and F3200 and VIGILANT RZDU panels - MX1, MX4428, F3200, FP1600, Sigma 5. The NSA is able to display alarms from all fire alarm panels connected to the network and this may be modified by programming to determine which alarms are displayed and what user responses are available.

Specifications

Operating Voltage	9.6 to 28.8Vdc
Current (maximum)	380mA @ 9.6V 180mA @ 27V
Network I/F	RS-485 (Panel-Link)
Programming I/F	DB-9 male RS232
Rating	IP41
Cabinet (surface)	250x150x50mm HWD
(flush)	301x192x75mm HWD
Weight	2.5kg

Part Numbers

FP0880	Nurses station, flush mount
FP0881	Nurses station, surface mount
LM0076	DB9F-DB9F prog. cable

AS 4428.1 Network Display Unit



The Network Display Unit (NDU) is a fire alarm repeater panel compatible with the Panel-Link Network and the associated range of networked fire alarm systems (eg. MX4428, F3200). It provides alphanumeric display of alarms on a 2 line by 40 character LCD and keypad. The NDU is able to display alarms and status, and control all fire alarm panels connected to the network.

FP0794 4U 19" Rack NDU Module

repeater panel compatible with the Panel-Link Network and the associated range of networked fire alarm systems (eg. MX4428, F3200). It provides alphanumeric display of alarms on a 2 line by 40 character LCD and keypad. The NDU is able to display alarms and status, and control all fire alarm panels connected to the network.

This may be modified by programming to achieve a variety of display and control facilities. Its compact "slimline" cabinet style has a flush mounting option, optional full cabinet complete with MAF relays and power supply, or 19" rack module. Local call point input, optional individual zone LED displays are all fully field programmable including: site name text, zone name text, selective display of alarms based on source panel and group membership. Analogue addressable fire alarm point text displayed, database save and restore to laptop/computer, event logging to history file and optional printer. The NDU includes firmware and PA0773 Panel-Link network RS485 interface card.

Part Numbers

FP0790	NDU, AS4428, MAF, PSU, full cab
FP0791	NDU, AS4428 Slimline surf. mnt
FP0792	NDU, AS4428 Slimline flush mnt
FP0793	NDU, AS4428 Slimline Deep incl.
I-HUB	
FP0794	NDU, AS4428 4U, 19" rack module

Specifications

Power Supply	External 24Vdc
Quiescent Current	19mA
Alarm Current	78 mA
Inputs	
RDU MCP	Supervised, 10k ohm EOL
RZDU Comms	F3200/F4000 compatible
Outputs	
Printer	Pseudo RS232, Xon/Xoff, 300 to 9600 baud
LED Display/Relay	33 (max) external boards
Display Type	FFCIF to AS 1603.4
LCD	2 lines of 40 characters, FFCIF, status std; opt zone
LEDs	
LEDs	
Operating Temp	-5°C to +45°C
Relative Humidity	10% to 95% (n/cond)
Cabinet Size (HWD)	750x550x211mm (FP0790) 177x450x50mm (FP0791) 219x502x75mm (FP0792) 177x450x75mm (FP0793) 177x483x45mm (FP0794)
Shipping Weight	3 kg (5kg FP0793)
ActivFire Listed	afp-789

AS 4428.1 Remote Display Unit



FP0789 4U 19" Rack Mount RDU

The AS4428.1 Remote LCD Display Unit (RDU) is a fire alarm repeater panel compatible with the MX4428 and F3200 range of fire alarm systems. It provides an alphanumeric display of alarms on a 2 line by 40 character LCD and keypad. The RDU's programmability enables remote displays to be configured for a variety of purposes using various modes of operation and freely programmable zone display mappings. In this way each RDU in a large system can be assigned to display exactly the zones required at that location. It is compatible with existing systems because the text messages displayed on the LCD are programmed locally.

Specifications

As per AS 4428 NDU (no network interface)

Part Numbers

FP0787	RDU, Slimline Wall Mount
FP0788	RDU, Slimline Flush Mount
FP0789	RDU, 4U 19" Rack

CCU Networking

CCU1

Communications Control Unit

CCU3



A network of Communications Control Units (CCU), called a CCUNet, can be used to connect multiple fire indicator panels and other supported devices to a central colour graphics system. This provides system wide control and annunciation of multiple fire detection systems. The CCU Network system and fire indicator panels are interconnected via dual redundant communication loops. The redundant network can be used to transparently route information around breakages and failures in the network. Event annunciation information from the fire panels is simultaneously routed via both the network CCUNet links.



Contact Johnson Controls when using CCU Networking, to ensure required system design and local standards criteria can be met.

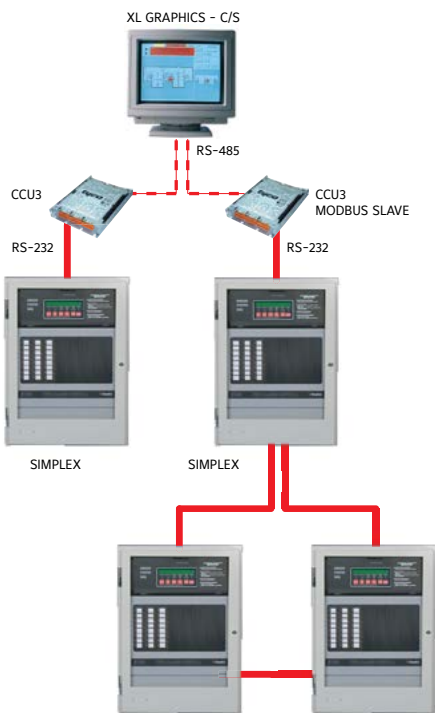

Two methods of connecting CCU3/C-4100MB to SIMPLEX CIE

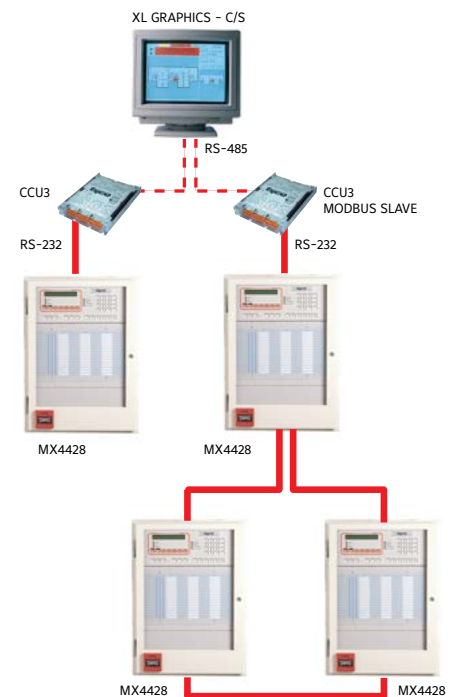

Two methods of connecting CCU3/C-MXMB to VIGILANT MX4428 CIE

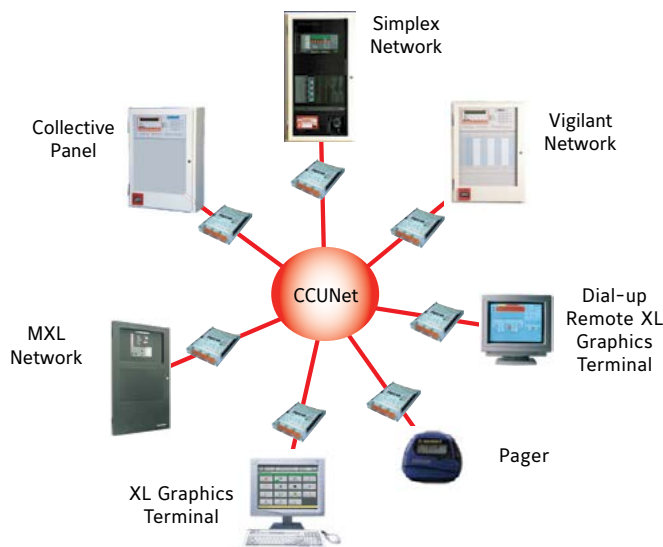

The CCUNet has the capability to integrate numerous fire panel networks into one simple colour graphics interface.

Example CCU System Diagram

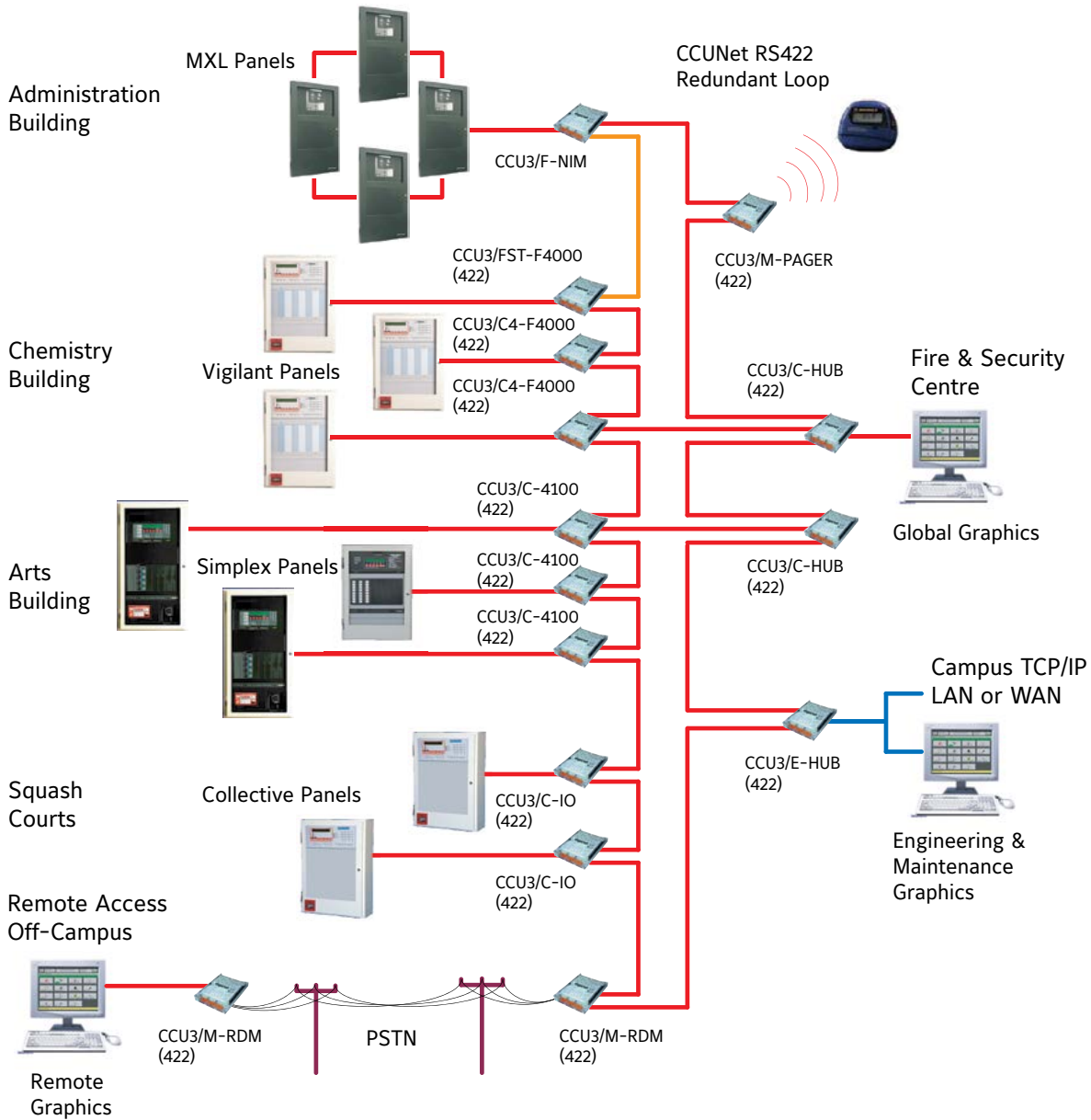

This example shows several buildings on a university campus each with their own different fire panels, linked together via CCU3s to a CCUNet by 2 loops.

Warning Systems

QE90 EWIS



The VIGILANT QE90 Emergency Warning and Intercommunication System (EWIS) is designed to facilitate the orderly evacuation of a building in the event of an emergency. Integrating a flexible alarm and voice warning system with a dedicated emergency intercom system, the QE90 allows fire wardens or emergency services personnel to easily control and coordinate rapid building evacuation.

QE90 meets the installation requirements of control and indicating equipment AS 1670.4, complies with equipment standard AS 2220.1 and supports the ISO 8201 T3 evacuation signal and strobe pattern.

Features

- Modular system is readily expandable
- Networked systems for site-wide interconnection (va copper, IP, fibre)
- High level input from compatible FIPs
- Choice of amplifiers providing a wide range of output power
- Optional standby amplifiers with automatic changeover
- Visual alarm outputs
- Factory programmable evacuation sequences
- Standard or custom voice messages (on-site recordable)
- Wiring supervision for amplifiers, speaker lines, visual alarm outputs, FIP inputs, MCP inputs, power supplies, WIP circuits and ECP interconnection
- Duplicated communications links between equipment locations
- Music & non-emergency paging (with emergency override)
- Paging console available for non-emergency paging
- Non-emergency voice messages
- Range of attractive 19" rack cabinets
- QECOST Software Tool for Windows assists the purchaser to specify and estimate the cost of a QE90 system
- Complies with EWIS standard AS 2220.1-1989
- Supports ISO8201 T3 evacuation signal
- ActivFire listed afp-524 (Wormald)
- ActivFire listed afp-1423 (Simplex)
- FPAZ listing number VF/406

Factory-Programmable Facilities:

- System configuration
- Control relay outputs
- Special cascade sequences
- Warden zones
- FIP/ emerg. call point input to zone mapping
- Special digitised voice messages

Basic System Comprises:

- Master Emergency Control Panel (MECP) complete with full control facilities for both Emergency Warning and Emergency Intercommunication Systems
- Individual amplifier(s) per zone
- Alert/ Evacuate tones with automatic digitised voice message
- Emergency public address
- Standard automatic alarm cascade sequence
- 3 WIP circuits per zone
- Full supervision of speaker, WIP and strobe lines with visual indications and sounder
- Fire alarm inputs (one per zone)
- Master background music (BGM) input
- One BGM override output per amplifier
- Integral 24 Volt battery charger
- Storage for stand-by batteries

Site-Programmable Facilities:

- Time delays
 - Alarm to Alert delay
 - Alert to Evacuate delay
 - Cascade step interval
- Alert/ Evacuate/ PA groups
- Background music zone selection
- Individual zone isolation
- Cascade enable/ disable
- Service fault history recall/ clear
- Redirection of Master WIP to field WIP (optional)
- Operation of non-emergency Paging Console to perform WIP, BGM and general indication functions

Optional Extra Facilities:

- More than 3 WIP circuits per zone
- Secondary Emergency Control Panel(s)
- Remote amplifier racks
- Multiple FIP/ emergency call point inputs per zone
- Emergency call point inputs
- 2 or 3-wire WIP/ emergency call point inputs
- Strobe (visual) alarm outputs (T3 option)
- Programmable relay outputs eg.
 - Evac fault
 - Any alarm
 - Fault or alarm
 - BGM override
 - Auto/ Man/ Isol.
 - WIP fault
 - WIP handset off hook
- Emergency control panel lighting
- Special cascade sequences
- Automatic test sequence
- Warden zones to alert wardens of alarm in another area
- Monitor zones to repeat the highest priority signal that other nominated zones are receiving
- After-hours timer input to override cascade
- Custom digitised voice messages (multiple languages available)
- Stand-by amplifier(s) with automatic changeover
- Distributed amplifier system
- Inter-ECP WIP calls (for systems with more than one ECP)
- Remote WIP phones via derived circuits (eg. fibre optics, radio)
- WIP calls redirected to PABX, radio, or other WIP
- Remote WIP control panel
- Individual zone BGM inputs
- Remote BGM control panel
- Paging console programmable to also perform WIP control and BGM control functions
- Paging chimes
- PABX paging interface
- Local zone non-emergency paging
- Event-logging printer
- High-level data links
- Networking (multiple media options)
- Computer colour graphics SECP

STOCK QE90 EWIS PANELS ARE AVAILABLE

- QS1000

Supplied in a standard pre-programmed configuration suitable for applications requiring no more than 10 zones of 50 watts. They are aimed primarily at projects requiring a basic format and quick delivery.

Specifications

Panel size	18U	21U	28U	40U	Double 28U	Double 40U
Height (mm)	885	1050	1330	1865	1330	1865
Width (mm)	575	575	575	575	1150	1150
MECP Depth (mm)	380	350	380	380	-	380
SECP Depth (mm)	205	-	205	205	205	-
Maximum number of zones with						
10W RMS Amps	8	20	20	40	-	80
25W RMS Amps	6	10	10	20	-	40
50W RMS Amps	4	10	10	20	-	40
100W RMS Amps	2	5	5	10	-	20
200W RMS Amps	2	2	2	4	-	8
Amplifier configurations can be mixed	10, 25, 50, 100, 200 Watt					
Speaker Line Voltage	100V RMS at rated power output					
WIP Zones (maximum)	10	18	20	42	-	90
SECP Zones (maximum)	1-18	-	19-34	35-42	43-74	75-90
Special or larger system configurations are available on request						
Cabinet Material	1.6mm mild steel					
Cabinet Finish	Baked epoxy					
Colour	Cream Wrinkle BFF998CW (special colours available on request)					
Operating Temperature	-5°C to +45°C					
Operating Humidity	up to 95% RH (non condensing)					
Power Supply	230VAC +10% -11%, 50Hz					

Spares - Refer to Page 125

A Combo QE90/Fire Panel is available. Contact Johnson Controls - Fire Detection for more information.

Refer to page 125 for a sample QE90 Configuration Sheet. These must be submitted with each QE90 order for new panels and upgrades to existing panels. Refer to the relevant Johnson Controls Product Bulletin for guidance on completing the configuration sheet LT0613.

QE90 Ancillaries & Spares

Paging Console



One or more Paging Consoles may be used with a QE90 system. Each console gives selective zone paging for up to 30 zones. These zones do not need to be the same as evacuation zones. Programming of any combinations of amplifiers into paging zones can be done by Johnson Controls - Fire Detection. If the system has more than 30 paging zones, then more than one Paging Console can be used at the same location to address the zones. The top of the Paging Console is removed to obtain access to the terminations. Only one microphone is required and it must be ordered separately.

Specifications	
Power Consumption	<50mA (no zones select) <150mA (all zones select)
Output Voltage	300 to 700mV
Microphone Voltage	1 to 100mV
Frequency Response	100 to 10kHz ±3dB
Distortion	10mV input, <2%
Dimensions (HWD)	80 x 410 x 210mm
Weight	4kg
Part Numbers	
FP0539	Paging Console
SU0168	Gooseneck Microphone
SU0169	Desktop Microphone
FA1922	Paging Console Keypad

PC Paging Console

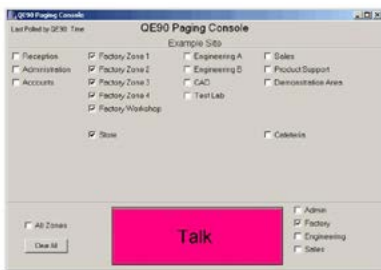

The PC-based Paging Console allows announcements to be made to up to 480 QE90 zones from a single Windows 2000/XP workstation, without requiring a separate physical paging console. The PC Paging Console interfaces a PC and microphone to the QE90 system. Control of paging individual or grouped evacuation zones is provided by software. Where the SU0168 microphone is used, the 'Press To Talk' button on the PC screen is used when a paging announcement is to be made. When using the SU0169 microphone it is necessary to use the PTT button on the microphone.

Specifications	
Platform	Windows 2000, XP
Capacity	Supports 480 QE90 zones and 10 user programmed groups of zones
Connection	via audio and comms, PC required with 2 free RS232 ports
Dimensions (HWD)	310 x 238 x 105mm
Part Number	FP0902

Hand Held Microphone with Press to Talk



ME0290 T-GEN/QE90 Mic. c/w 4-way Flat Plug (ECP9702 only)

ME0213 QE90 Mic. c/w DIN Plug (old ECP9002 only)

The hand held dynamic microphone is fitted with a press-to-talk button. It is suitable for plugging into T-GEN 50 and QE90 to provide emergency PA and recording of digitised speech message. Two models are available; ME0213 has a DIN plug for use on older QE90 ECP9002, and ME0290 has a 4-Way flat plug for use on T-GEN 50 and QE90 ECP9702.

Part Numbers	
ME0213	Microphone c/w DIN plug for old QE90 ECP9002 only
ME0290	Microphone c/w 4-way flat plug for T-GEN 50 and QE90 ECP9702 only

SU0168 Gooseneck Microphone



The SU0168 Gooseneck Paging microphone is a dynamic microphone with a cardioid polar pattern. This elegant gooseneck microphone features smooth, brilliant sound with excellent ambient noise control and feedback rejection. Its screw base is suitable for mounting on equipment or permanent desk mounting. The slimline design of this microphone makes it ideal for custom paging consoles.

It is supplied with 200mm flying leads and mounting kit for FP0539 Paging Console.

Specifications	
Polar Pattern	Cardioid (unidirectional)
Output Impedance	600 Ohm balanced at 1kHz
Rated Sensitivity	-80dB (1kHz, 0dB=1 V/Pa)
Frequency Response	150Hz-12KHz
Part Number	SU0168

SU0169 Desktop Microphone



The SU0169 Paging microphone is a desktop dynamic microphone with a cardioid polar pattern. It features a short-off press to talk switch with an open-off type extra switch. It has low handling noise and a 600 ohm balanced output impedance. Compatible with the FP0539 Paging Console.

Specifications	
Polar Pattern	Cardioid (unidirectional)
Output Impedance	600 Ohm balanced at 1kHz
Rated Sensitivity	-58dB (1kHz, 0dB=1 V/Pa)
Frequency Response	100 Hz to 10KHz
Cable	2 core shielded plus 2 core
Cable Length	2.5m
Termination	5 pin DIN plug
Dimensions (HWD)	215 x 100 x 150mm
Weight	440g
Part Number	SU0169

FP0938 WIP Phone



Designed specifically for use in VIGILANT Emergency Warning Systems, Warden Intercom Points (WIPs) are used to communicate between floor wardens and the main Emergency Evacuation Panel. When the handset is lifted, the WIP automatically rings the Emergency Evacuation Panel. When the Panel calls the WIP, the call tone sounds through the speaker in the body of the phone. When the handset is lifted, it automatically switches from the speaker in the body to the speaker in the handset. The FP0938 is compatible with the VIGILANT QE90 Emergency Intercommunication System.

Specifications

Call Tone	> 80dB 1W/1m
AC Impedance	600 Ohms (off-hook)
Screw Terminations	To suit 0.75 to 1.5mm ² wire
Ambient Temp	-10°C to +50°C
Material	Red ABS
Dimensions (HWD)	215 x 70 x 70mm
ActivFire Listed	afp-524

Part Numbers

FP0938	WIP Phone
C0612D	External Speaker

EA0412 WIP Phone Surface Mount Enclosure



EA0412 is designed for use in Emergency Warning Systems, for protection of Warden Intercom Points (WIPs) against impact. The enclosure door is held closed by a magnetic catch. The enclosure is open-backed and is finished in red powder coat.

Specifications

Material	Mild Steel
Finish	Red powdercoat
Dimensions (HWD)	386 x 156 x 155mm
Weight	1.8 kg
Part Number	EA0412

SU0608 Evacuation Manual Call Point (White)



The SU0608 MCP is surface mounting, with a plastic coated glass element to ensure reliable, safe operation. It is coloured white (for EWIS applications) to be used where a fire alarm system does not exist. The call point is operated when the glass element is snapped, releasing the MCP's micro switch, which signals an alarm to the EWIS panel. The element is snapped by pressing on its centre – a hammer, or other impact device, is not required.

Specifications

Max Current	2A @ 30Vdc
Contact Resistance	100mOhm. (max)
Legend	Emergency Alarm
Ambient Temp	-10 to +55°C
Relative Humidity	95%(non cond.)
Ingress Protection	IP24D
Dimensions (HWD)	93 x 89 x 60 mm
Part Numbers	
SU0608	White MCP & Backbox
515.001.025	Spare Glass (pk 5)

STI-CIS Analyser and STI-CIS TALKBox



The STI-CIS Analyser measures the speech intelligibility of a fire alarm evacuation signal. To measure overall speech intelligibility, the STI-CIS Analyser uses the STI measurement method to factor in the effects of the warning system, room acoustics (reverberations and echoes) and background noise.

The STI-CIS Analyser comes equipped with its own microphone and LED display and has buttons to activate dBA and CIS measurements. There is provision for a PC interface (RS-232) for use with the STI-CIS Noise Effect Correction Software Tool.

Specifications - Analyser

Ambient Temp	0 to 50°C
Power Supply	8 x AA batteries/AC adaptor
Dimensions (HWD)	410 x 250 x 70mm
Weight	160g

Specifications - TALKBox

Power Supply ¹	12Vdc, 190mA via 8 x AA batteries or AC adaptor at 500mA (12Vdc, tip positive)
SPL Output	0 dB to 100 dBA (STI-PA test tone)
Ambient Temp	0 to 50°C
Dimensions (HWD)	470 x 360 x 180mm
Weight	520g

Part Numbers

STI-CIS	Analyser & TALKBox Kit - 2 cases
---------	----------------------------------

1. 92dB(A) STI-PA tone out

The TALKBox is used to send the STI-PA test tone into the fire alarm warning system. It interfaces with the system through its microphone input. A line-level output is also available for systems with direct line inputs. The TALKBox comes equipped with its own CD player and speaker. The CD player has controls to Play, Rewind, and Fast Forward the CD with STI-PA test tone (supplied). However, pressing Play on the CD player is all that is required to play the test tone once you insert the STI-PA Test Tone CD into the CD player. Power is supplied to the TALKBox through a DC power supply (connected to the Ext. Power socket) or batteries. The TALKBox operates a minimum of 18 hours on eight AA alkaline batteries.



QE90 Spares - Amplifiers

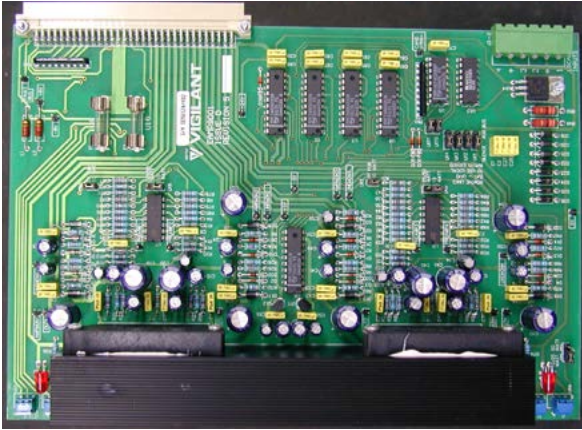

PA0650 EAMP9001
4x10W / 2x25W Zone Power Amplifier PCB
Dimensions 233x159x48mm



PA0688 1923-19
Microvac Mic Pre-Amp

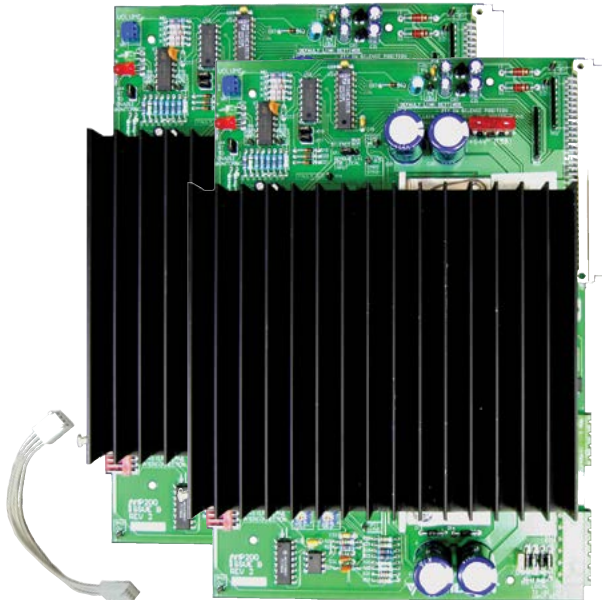

KT0519 200W Amplifier Module Kit
The 200W amplifier comprises two PA0647 AMP200 PCB modules and one LM0141 FRC loom.



PA0690 HAMP9308
2x50W Amplifier Module

QE90 Spares - Transformer Modules



PA0691 HTRN9308-1
2x50W Transformer Module



PA0692 HTRN9308-2
1x100W Transformer Module



PA0695 HTMS9408-2
2x50W Transformer Music Switching Module

PA0696 HTMS9408-2
1x100W Transformer Music Switching Module

PA0648 TRAN200
200W Transformer
Typical Dimensions 140x140x85mm, 3kg

QE90 Spares - Transformer Modules



FP1078 TRAN9705-2 (PA0792)
4x25W Transformer Module c/w
Relays incl. 2x PA0650 EAMP9001

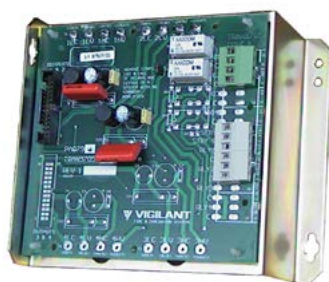

FP1076 TRAN9705-4 (PA0794)
2x25W Transformer Module c/w
Relays incl. PA0650 EAMP9001



PA0795 TRAN9706-1
4x10W Transformer Module
without Relays

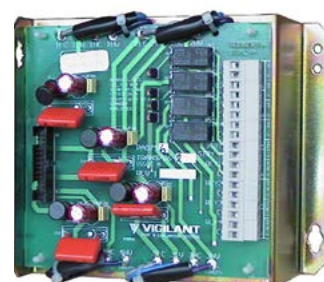

FP1077 TRAN9706-2 (PA0796)
4x10W Transformer Module c/w
Relays incl. PA0650 EAMP9001

QE90 Spares - Interface Modules



PA0657 SE9004 Signal Interface



PA0481 RZDU/RS232
Interface 1901-100,
includes LM0061



PA0644 VIF0907
VoIP Interface incl. 1x LM0448, 2x
LM0552, DIN rail mntg h'ware



FP1071 SPIF9709
(PA0649) SECP Panel
Interface PCB

QE90 Spares List - Major Components

Part No.	Description	Part No.	Description
FA2027	Keypad Only, ECP+2Z Keyboard, no Name, 3 WIP per Zone	PA0758	PCB Assy, QE90, EMUX9601, Multiplexer 16sec Speech
FA2029	Keypad Only, 8Z Extender Keyboard, 3 WIP per Zone	PA0759	PCB Assy, QE90, EMUX9601, Multiplexer 60sec Speech
FP1083	Display Assy 3 WIP per Zone, 8 Zone Extender incl. PCB	PA0792	PCB Assy, TRAN9705-2, 4x25W Module c/w Relays
ME0207	ECP Assembly 3 WIP per Zone including ECP	PA0794	PCB Assy, TRAN9705-4, 2x25W Module c/w Relays
ME0381	Assy, ECP + 2Z Keybd, 3WIP/Z Inner Door & Keypad only (>21u)	PA0795	PCB Assy, TRAN9706-1, 4x10W Module Without Relays
ME0382	Assy, ECP 8Z Keybd, 3WIP/Z Inner Door & Keypad only (>21u)	PA0796	PCB Assy, TRAN9706-2, 4x10W Module c/w Relays
PA0623	PCB ECP9702-2 Evac Cntrl, Socket for Site-Specific WIP s/w	PA0916	PCB Assy, QE90 WTRM2000, WIP Termination (DIN)
PA1144	PCB Assy, WIPS2017 WIP Slave, 0v Ref	FP1068	PCB Assy, FIB8910 FIP/BGA Master (DIN Rail)
PA0643	PCB Assy, ECP9702-2 Evac Cntl Panel 3WIP/Zone	FP1069	PCB Assy, FIPE9004 FIP/BGA Extender Module (DIN Rail)
PA0646	PCB Assy, ALIM9706 Audio Line Isolator Module	FP1070	PCB Assy, QE90 STRM9502 Strobe/relay Module (DIN Rail)
PA0647	PCB Assy, AMP200 200W Amplifier Module	FP1071	PCB Assy, SPIF9709 Secondary Panel Interface (DIN Rail)
PA0648	PCB Assy, TRAN200 200W Transformer Module	FP1072	PCB Assy, QE90 ECM9603 Evac Comms Module (DIN Rail)
PA0650	PCB Assy, EAMP9001 4 Zone Power Amp	FP1073	Assy, WIP Slave + Termination PCBs Upgrade Kit
PA0653	PCB Assy, EMSP8911-2 Disp Kbd 3WIP/Zone - refer FP1083	FP1074	Assy, 100W Amp + HTRAN9308-2 Upgrade Kit
PA0657	PCB Assy, QE90 SE9004 Signal Interface (DIN Rail)	FP1075	Assy, 2x50W Amp + HTRM9308-1 Upgrade Kit
PA0660	PCB Assy, QE90 BPLN2000 Backplane	FP1076	Assy, 2x25W Amp + TRAN9705-4 Upgrade Kit
PA0690	PCB Assy, QE90 HAMP9308 2x50W Amplifier Module	FP1077	Assy, 4x10W Amp + TRAN9705-2 Upgrade Kit
PA0691	PCB Assy, QE90 HTRM9308-1 2x50W Transformer Module	FP1078	Assy, 4x25W Amp + TRAN9705-2 Upgrade Kit
PA0692	PCB Assy, QE90 HTRM9308-2 1x100W Transformer Module	FP1079	Assy, 200W Amp + TRAN200 Upgrade Kit
PA0695	PCB Assy, QE90 HTMS9408-1, 2x50W Xfmr Mod Music Sw		

Refer to Page 125 for comprehensive list

QE90 Spares



PA1144 WIPS2017
WIP Slave Module 0V Ref Inputs



PA0916 WTRM2000
WIP Termination Module



PA0646 ALIM9706
Audio Line Isolator Module



FP1068 FIB8910 (PA0651)
FIP/BGA Master Module
DD0084 FIP EOL Zener Diode

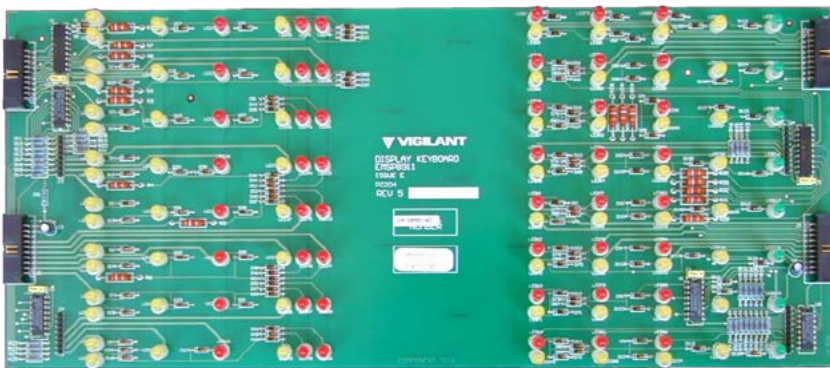

PA0653 EMSP8911-2
3 WIP/Zone Display Keyboard Module
For replacement part use FP1083

FP1083 8Z Display Extender 4U Door
FA2029 8Z Extender Keypad only

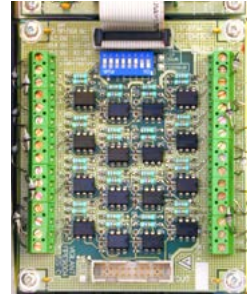

FP1069 FIPE9004 (PA0652)
FIP/BGA
Extender Module



PA0643 ECP9702-1
3 WIP/Zone Control Module

ME0207 ECP+2Z Display 4U Door
FA2027 ECP+2Z Keypad only



FP1070 STRM9502
(PA0697) Strobe/Relay
Module (WEB) with AS
2220/ISO 8201 Selection

QE90 Spares – Communications



FP1072 ECM9603 (PA0698)
Evac Communications Module

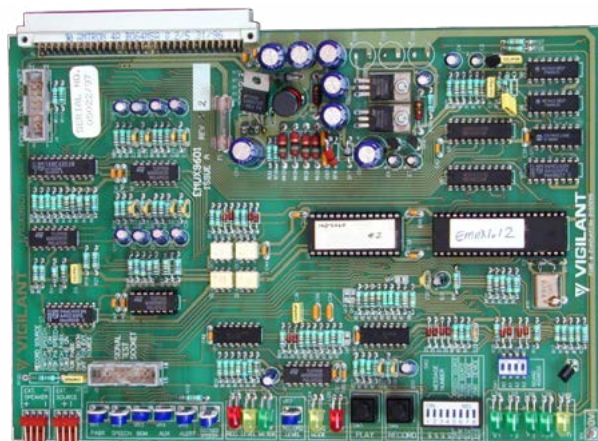

PA0758/759 EMUX9601
Multiplexer 16/60s Speech with
AS 2220 and ISO 8201 Selection

Warning System Generators

Mini-Gen Mk2

Mini-Gen Mk2 connects directly to VIGILANT fire alarm panels, but may be connected to other suitable panels. It utilises the fire alarm panel's warning system output supervision to supervise the wiring for open and short-circuit faults. Mini-Gen Mk2 has in-built software allowing link selection to configure the Alert and Evacuate signal type, timing including keywords and voice message. **Part Numbers:-** PA1026 (PCB only), 4100-1026K (SIMPLEX bracket).

T-Gen2 Emergency Warning System

New standard, new protection.

VIGILANT continues to be synonymous with effective and reliable Emergency Warning Systems.

The T-Gen2 is the heart of a range of new, sophisticated Emergency Warning Systems (EWS) complying with AS 4428.16 and NZS 4512. Drawing on over 100 years of innovation, T-Gen2 is powerful, feature-packed, yet easily configured to suit almost any installation requirement.

The T-Gen2 tone generator/amplifier module provides a 100V audio output suitable for wiring to multiple 100V loudspeakers located in the evacuation zone of the building. Available in two configurations – T-Gen 60 which provides a 60W rms output and T-Gen 120 which provides 120W rms. Both models include:

- 2A supervised strobe output
- 6 Supervised digital inputs
- 4 Open collector outputs
- PA Mic audio/PTT input
- 2 Line-level audio inputs
- Master/slave operation

Grade 3

A single evacuation zone (all-out) system where the same warning signal is generated throughout the building. A single storey building of less than 2000m² will have a single output from the Emergency Warning System wired to all speakers. A multi-storey building (up to 25m high) or a single storey of greater than 2000m² will need separate outputs per floor or area greater than 2000m². These can be provided by adding 100V Splitter or Switching Modules to the T-Gen2 output, or using Slave T-Gen2 units connected to the Master T-Gen2.

Grade 2

Used where separate evacuation signals or phased evacuation is required to multiple evacuation zones, but where a Grade 1 or Emergency Intercom System isn't required under the National Construction Code. Used in buildings up to 25m high.

Grade 2 is a multi-zone Emergency Warning System where the activation and silencing of the warning signals may be controlled by the fire alarm panel. A Grade 2 system may have a phased evacuation and may involve an alert signal and/or emergency speech function. It must be powered separately to the fire alarm panel.



Residential Care
Apartment Building
Backpackers



Carpark
Detention Facility



Hotel
School Residential
Accommodation



Shopping Centre



Office Building



Warehouse



Apartment Building
Backpackers
Carpark



Detention Facility
Hotel
Office Building
Warehouse

At a Glance

Grade 3 – simple 'all-out' EWS single/multi-level buildings

Grade 2 – phased evacuation, multi-zone EWS

T-Gen2 Emergency Warning Generator



FP1115 T-Gen60 60W Amplifier Module
FP1116 T-Gen120 120W Amplifier Module (with fan)



FP1139 14A 24V PSE for T-Gen2
FP1142 14A PSE mounting bracket for 4100 PDI bay - not shown

T-Gen2

The VIGILANT T-Gen2 is an Emergency Warning System (EWS) with a supervised 100V speaker line and digitised speech messages. The T-Gen2 is typically installed in a fire alarm panel; it is readily mounted in the VIGILANT MX1 and SIMPLEX 4100ESi panels, or in stand-alone Grade 3 Building Occupant Warning Systems or Grade 2 Emergency Warning Systems. Two amplifier modules are available.

FP1115

T-Gen60 is able to drive a 100V line speaker output with up to 60W of load. It supports two non-emergency audio inputs (background music, paging), a microphone audio input (speech or paging), 6 supervised inputs (Alarm, Fault, Paging), 4 open-collector outputs, normally-energised Fault relay, and a supervised single polarity 2A strobe output.

FP1116

T-Gen120 is able to drive a 100V speaker load up to 120W and supports the same features as the T-Gen60.

Slave Operation

Up to 10 T-Gen2 can be wired together for additional power output.

Tone Generator

The T-Gen2 amplifier module generates emergency warning signals for alarm and occupant warning systems where a full EWCIE to AS 1670.4 is not required. Different tones can be selected including AS 4428.16, AS 2220 Alert and Evacuate signals and the ISO 8201 Temporal pattern Evacuate Signal. T-Gen2 provides speaker line fault supervision, public address facilities and pre-recorded voice messages.

Operation and Configuration

Operation of the T-Gen2 is controlled by the programmable configuration held within it. This configuration can be selected from a number of pre-defined setups or specifically modified using a PC software - SmartConfig. This provides flexibility to customise the programming configurations and interface to other optional modules.

Specifications

	FP1115	FP1116
Weight	0.65kg	1.5kg
Dimensions (mm)	125x195x55	125x195x110
Supply Voltage	19.2Vmin to 28.8Vmax	
Operating Temperature	-5°C to +45°C	
Relative Humidity	0 to 95% non-condensing	
Storage Temperature	-20°C to +70°C	
Quiescent Current	45mA ¹ to 170mA ²	
Active Current 27Vdc ⁵	3.0A @ 60W	6.0A @ 120W
Line Voltage	100VAC rms (tones)	
- AC (Tones)	2.5Vdc (56k ELD 5.0V (O/C)	
- DC (Supervision)	60W	120W
Line Power Tones/Audio	200nF	
Maximum Line Capacitance	260Hz - 3800Hz	
Audio Frequency Range	215Hz - 8400Hz	
+/- 1dB		
+/- 3dB		
Audio Performance	>75dB(A)	
SNR	<0.25%	
THD		
100V Speaker Line Supervision		
ELD - 1 Branch	56k 0.4W	
- 2 Branches	100k 0.4W	
Strobe Output		
ELD 1 to 3 branches	1x10k to 3x27k 0.4W	
Current Rating	Max 2.0A	
Audio Inputs		
Audio 1 & Audio 2	250mV rms (min) into 5k Ohm ³	
Microphone Input Level	3mV rms to 100mV rms ⁴	
Digital Inputs Supervision	2k7 EOL, <3.5V Active	
Open Collector Outputs	<1V @ 100mA max., 30Vdc	
Fault Relay	Change-over, 2A @ 30Vdc	
Interfaces	OLED, 4 button menu structured QBus Master/Slave, User I/F, PSE 100V Switching Module 4MB (config. & audio) 32GB max. FAT32 support	
On-board Storage		
MicroSD Card		
Headphone Output (internal)		
- Load impedance	8 Ohm (min) 6mW	
- Output Level	1.30V rms	
ActivFire Listed	afp-3315	
FPANZ Listed	VF/424	VF/425

Notes.

1. Power Save Mode (audio off)
2. Audio idle
3. Isolated, for full power
4. PTT driven, optionally supervised
5. Excludes strobe current

T-Gen2 Emergency Warning System (EWS) - Grade 3



FP1121 3U Grade 3 User Interface with T-Gen60 & mic., shown installed in 15U VIGILANT MX1



FP1144 8U 60W T-Gen2 Grade 3 BOWS

The VIGILANT T-Gen2 Grade 3 EWS forms part of a Building Occupant Warning System (BOWS) that can be incorporated into fire panels with the T-Gen2 powered from the FIP power supply.

For larger systems the FP1139 PSE can be added to power the T-Gen2 amplifiers.

A 3U User Interface with PA microphone can be supplied in grey or black to suit the MX1 and 4100ESi respectively.

Additionally the grey 3U User Interface is available with a T-Gen60 mounted on the rear.

A self-contained Grade 3 BOWS containing a T-Gen2, integral power supply and PA microphone can be supplied to connect directly to a fire alarm panel, but can also be used as a stand-alone unit. The BOWS is available in 2 standard configurations:

- 8U with 60W audio output for smaller buildings (exp. to 2x 60W outputs)
- 15U with 120W audio output (exp. with an additional 60W / 120W output)

Both support a number of optional 100V Switching or 100V Splitter Modules to provide multiple protected outputs.



FP1134 15U 120W T-Gen2 Grade 3 BOWS

Specifications

	FP1144 (8U)	FP1134 (15U)
Weight	17.5kg	26kg
Dimensions (HWD mm)	440x550x210	750x550x210
Supply Voltage	19.2Vmin to 28.8Vmax	
Operating Temperature	-5°C to +45°C	
Relative Humidity	0 to 95% non-condensing	
Storage Temperature	-20°C to +70°C	
Quiescent Current	290mA ¹	
Active Current 27Vdc ⁵	3.1A @ 60W	6.1A @ 120W
Line Voltage		
- AC (Tones)	100VAC rms (tones)	
- DC (Supervision)	2.5Vdc (56k ELD 5.0V (O/C)	
Line Power Tones/Audio	60W rms	120W rms
Maximum Line Capacitance	200nF	
ActivFire Listed	afp-3315	
FPANZ Listed	VF/429	VF/430

Notes.

1. Power Save Mode (audio off)
2. Audio idle
3. Isolated, for full power
4. PTT driven, optionally supervised
5. Excludes strobe current



FP1122 3U Grade 3 User Interface incl. mic., no PCB (Gry)

FP1123 3U Grade 3 User Interface incl. mic., no PCB (Blk)



FP1117 T-Gen2 Switching Module

FP1118 T-Gen2 Splitter Module



FP1143 High Level Interface module

The 100V Switching and Splitter Modules provide 4x 100V speaker outputs from one 100V input, with each output separately supervised and isolated if a short circuit fault is detected.

Specifications

	FP1117	FP1118
Operating Voltage	19.2V to 28.8Vdc	
Quiescent Current	10mA @ 24V	15mA @ 24V
Alarm State Current ¹	43mA @ 24V	40mA @ 24V
100V EOL Resistor	56k Ohm (1 branch) 100k Ohm (2 branches)	
100V load/output	100W	
100V load (all 4 outputs)	120W	
Relay Contact Rating	-	1A @ 24Vdc
Fault on 100V in	-	25k Ohm
Ambient Temperature	-5°C to +45°C	
Relative Humidity	10% to 95% (non cond.)	
Dimensions (HWD)	142 x 104 x 40 mm	
Wire Size (maximum)	2.5sq. mm	
ActivFire Listed	afp-3315	afp-3315
FPANZ Listed	VF/426	VF/427
Part Numbers	FP1117	FP1118

1. All 4 outputs in short circuit fault.

Part Numbers

FP1115	T-Gen60 Class D 60W amplifier
FP1116	T-Gen120 Class D 120W amplifier
FP1117	4-Way 100V Switching Module
FP1118	4-Way 100V Splitter Module
FP1119	T-Gen2 60W/120W mounting brkt for PDI bay
FP1120	T-Gen2 Splitter/Switching Module brkt for PDI
FP1121	3U Grade 3 User Interface with T-Gen60, mic.
FP1122	3U Grade 3 UI and microphone (grey)
FP1123	3U Grade 3 UI & mic (black for Simplex)
FP1130	15U Expansion cabinet, gear plate, 14A PSE
FP1134	15U 120W T-Gen2 Grade 3 BOWS, 14A PSE
FP1135	60W Isolation Amplifier
FP1139	14A 24V PSE gear plate mount
FP1142	14A PSE mounting bracket for PDI bay
FP1143	T-Gen2 High Level Interface module
FP1144	8U 60W T-Gen2 Grade 3 BOWS, 14A PSE
ME0290	Dynamic Microphone with 1m coiled lead
ME0490	ME0290 Dynamic microphone with longer lead
ME0292	T-Gen Empty Box 240W x 295H x 85D

T-Gen2 Emergency Warning System (EWS) - Grade 2

This is a multi-zone EWS where the activation and silencing of the warning signals is controlled by the fire alarm system. This will usually have a phased evacuation and may involve the alert signal as well. The emergency Speech function may also be present. It must be powered separately to the fire alarm panel, but is controlled by it.

A Grade 2 EWS may be used in buildings up to 25m high, where phased evacuation is required but Warden Intercom Point phones are not used.

The Grade 2 EWS and associated 14A PSE may be housed with the MX1 or 4100ESi FIP in a suitable 28U to 40U cabinet, or supplied as a self-contained EWS in its own cabinet. Up to 20 zones in total can be provided by adding a FP1126/27 8-zone 3U Expansion door fitted with an optional FP1128 8-zone expansion kit.



FP1129 T-Gen2 120W 15U Grade 2 EWS
FP1130 T-Gen2 15U EWS expansion cabinet (not shown)



FP1128 T-Gen2 8-zone Grade 2 expansion board



FP1126 T-Gen2 3U Grade 2 Zone Extender



FP1124 T-Gen2 3U Grade 2 User System Interface incl. Microphone



SU0360 4-Zone Paging Console, A4488

A self-contained EWS is available in a standard configuration (FP1129) in a 15U cabinet with a 120W audio output and one 100V Switching Module. It can be expanded to support two T-Gen120 amplifiers or up to six Switching Modules for additional zone outputs.

The gear plates of FP1129/FP1130 can support up to 3x T-Gen60 /T-Gen120 units, up to 2x 14A PSE, up to 10x 100V Switching/Splitter Modules and 1 HLI module.

The FP1130 expansion module cabinet must be mounted immediately adjacent to the FP1129 EWS cabinet with the interconnection cabling running directly between them.

Specifications

Specifications	FP1129 (15U)
Weight	26kg
Size (HWD)	750 x 550 x 211 mm
Supply Voltage	19.2V to 28.8V
PSU Capacity	14A Peak
Battery Space	2x 40Ah
Operating Temp.	-5°C to +45°C
Relative Humidity	0 to 95% non-cond.
Storage Temp.	-20°C to +70°C
Quiescent Current ¹	300mA
Op. Current@27Vdc ⁴	6.2A @ 120W
Line Voltage AC	100V rms
- DC (Supervision)	2.5V (56k ELD 5.0V (O/C)
Line Power	120W
Maximum line cap.	200nF
Audio Performance	
SNR	>75 db(A)
THD	<0.25%
Freq. range +/- 1dB	260Hz - 3800Hz
Freq. range +/- 3dB	215Hz - 8400Hz
100V Speaker Line Supervision ELD	
- 1 Branch	56k 0.4W
- 2 Branches	100k 0.4W
Strobe Output	
- 1 to 3 branch	1x10k - 3x27k 0.4W
Current rating	Max 2.0A
Audio Inputs 1 & 2	250mVrms (min) into 5kOhm ²
Mic. Input Level	3mV rms to 100mV rms ³
Digital Input Supervision	2k7 EOL, <3.5V Active
Open Collector Outputs	<1V @ 100mA, 30Vdc
Fault Relay	Change-over, 2A @ 30Vdc
Interfaces	OLED, 4 button menu
Master/Slave	Up to 9 slaves
On-board Storage	4MB (configuration and audio files)
MicroSD Card	32GB max size FAT32 support
Headphone Output (internal)	
Load impedance	8 Ohm min 6mW
Output Level	1.30V _{RMS}
ActivFire Listed	afp-3315

Notes.

1. Audio idle
2. Isolated, for full power
3. PTT driven, monitored
4. Excludes strobe current

Part Numbers

FP1115	T-Gen60 Class D 60W amplifier
FP1116	T-Gen120 Class D 120W amplifier
FP1117	4-Way 100V Switching Module
FP1118	4-Way 100V Splitter Module
FP1119	T-Gen2 60W/120W mounting brkt for PDI bay
FP1120	T-Gen2 Splitter/Switching Module brkt for PDI
FP1124	3U Grade 2 UI and microphone (grey)
FP1125	3U Grade 2 UI & mic (black for Simplex)
FP1126	3U Grade 2 16-zone UI extender (grey)
FP1127	3U Grade 2 16-zone UI extender (black)
FP1128	8-Zone Expansion board for FP1126/27
FP1129	15U 4-Zone 120W T-Gen2 Grd 2 EWS, 14A PSE
FP1130	15U Expansion cabinet, gear plate, 14A PSE
FP1139	14A 24V PSE gear plate mount
FP1142	14A PSE mounting bracket for PDI bay
FP1143	T-Gen2 High Level Interface module
SU0360	A4488 4-Zone Paging Console
SU0361	A4489 Audio Switcher module (use with SU0360)
ME0290	Dynamic Microphone with 1m coiled lead
ME0490	ME0290 Dynamic microphone with longer lead

Warning System Ancillaries

VADs - Conventional Sounders / Beacons AS740.3 / 23 approved

The Solista and ROLP visual alarm devices (VAD) are AS ISO 7240.23 approved and SAI Global listed. Each VAD has a unique lens design that distributes the red or white light to achieve the required illumination whilst using minimum current consumption.

The VADs are ideal for a variety of applications, including bedrooms, bathrooms and toilets, and plantrooms. They can be used on MX1, 4100ESi and QE90. A matching range of "Tag" plates is also available so the visual alarm devices can be installed to AS 1670.1:2018 and AS 1670.4:2018.

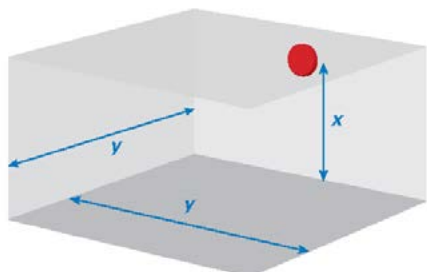

VAD Class Designation

Each VAD has a class designation that defines the VAD usage and coverage area. The Wall VADs have a code of W-2.4-7.5. The W means it's a wall mountable VAD, the 2.4 means the VAD can be mounted up to a height of 2.4m (x) from the floor, and the 7.5 means the flash intensity covers an area of 7.5m x 7.5m (y) in front of the VAD.

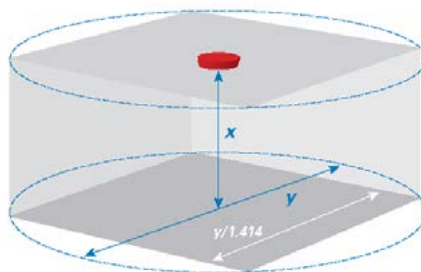

The ceiling mounted VADs have a rating of C-3-7.5. This means it's a ceiling mountable VAD, which can be installed to a height of 3m (x), and covers a cylindrical area of 7.5m (y) diameter around the VAD.

VAD Features

- Low current consumption of 10-25mA
- Wide operating voltage, with built-in diode
- Up to 7.5m x 7.5m coverage area
- 0.5Hz or 1Hz Flash rate, high & low intensity flash
- AS ISO 7240.23 approved
- SAI Global listed - Licence No: SMK40585



RoLP Sounder

Voltage	18-28Vdc
Current	12mA (Typical Tone 3)
Sound Output	102dB(A) (Typical Tone 3)
Tones	32
Volume Control	10dB
Monitoring	Reverse Polarity
Temperature Protection	-25°C to +70°C
Construction	IP54 (s)* IP65 (d)*
Weight	0.25Kg
Colours	Red or white
Sync	Automatic Synchronisation
(s)* Shallow Base	
(d)* Deep / U Base	

Part Numbers

576.080.020	Red Body Deep base (IP65)
576.080.025	White Body Shallow Base



Solista LX Wall Beacon

Mounting Type	Wall
Voltage	9 - 60VDC
Current	10 - 25mA
	(dependent on setting)
Coverage (y)	7.5m (Switchable to 2.5m)*
Mounting Height (x)	2.4m (max)
Coverage Vol. Code	W-2.4-7.5
Coverage Vol.	135m3 (15m3)
Flash Rate	1Hz (Switchable to 0.5Hz)
Operating Temp.	-25°C to +70°C
Monitoring	Reverse Polarity
Protection	IP33C Shallow Base
	IP65 Deep and U Base
Weight	100g
Body Colour	White or Red
Flash Colour	White or Red
Sync	Automatic Synchronisation of flash rate

* CNPP test results

Part Numbers

576.080.016	Red Flash Red body Deep base (IP65)
576.080.022	Red Flash White Body Shallow base
576.080.018	White Flash White Body shallow base



RoLP LX Wall Sounder Beacon

Mounting Type	Wall
Voltage	18 - 28VDC (Fire Use)
Current	22 - 37mA
	(dependent on setting)
Coverage (y)	7.5m (Switchable to 2.5m)*
Mounting Height (x)	2.4m (max)
Coverage Vol. Code	W-2.4-7.5
Coverage Vol.	135m3 (15m3)
Flash Rate	1Hz (Switchable to 0.5Hz)
Operating Temp.	-25°C to +70°C
Monitoring	Reverse Polarity
Protection	IP65
Weight	200g
Body Colour	White or Red
Flash Colour	Red
Sound Output	102dB(A)
	(Typical tone 3 - RoLP)
Sync	Independent synchronisation of flash rate and tone

* CNPP test results

Part Numbers

576.080.024	Red Flash White Body
576.080.019	Red Flash Red Body



Solista LX Ceiling Beacon

Mounting Type	Ceiling
Voltage	9 - 60VDC
Current	10 - 25mA
	(dependent on setting)
Coverage (y)	7.5m (Switchable to 3m)*
Mounting Height (x)	3m (max)
Coverage Vol. Code	C-3-7.5
Coverage Vol.	132m3 (21m3)
Flash Rate	1Hz (Switchable to 0.5Hz)
Operating Temp.	-25°C to +70°C
Monitoring	Reverse Polarity
Protection	IP33C Shallow Base
Weight	100g
Body Colour	White
Flash Colour	White or Red
Sync	Automatic Synchronisation of flash rate

* CNPP test results

Part Numbers







576.080.023	Red Flash White Body Shallow base
576.080.017	White Flash White Body Shallow base

Fire Detection Product Catalogue

VADs - Conventional Sounders / Beacons AS740.3 / 23 approved (continued)

Tag Plates

The EA0345- EA0350 VAD Tag Plates are a series of "FIRE" and "EVACUATE" lettered signs suitable for installing alongside a Visual Alarm Device (VAD) to comply with the VAD installation requirements in AS 1670.1 and AS 1670.4. Each tag plate is supplied with installation instructions, packaged in a plastic bag.

Part number	Photo	Tag plate description
EA0345		Round white tag plate with 15mm black FIRE and EVACUATE text. Application: use with indoor round wall / ceiling-mounting VADs and bases.
EA0346		Rectangular stick on (adhesive backed) white tag plate with 15mm black FIRE text. Application: use with indoor VADs.
EA0347		Rectangular stick on (adhesive backed) white tag plate with 15mm black EVACUATE text. Application: use with indoor VADs
EA0348		Rectangular stick on (adhesive backed) red tag plate with 15mm white FIRE text. Application: use with indoor VADs
EA0349		Rectangular stick on (adhesive backed) red tag plate with 15mm white EVACUATE text. Application: use with indoor VADs.
EA0350		Rectangle red tag plate (adhesive backed) with 50mm white FIRE text. UV stable material suitable for outside use. Application: Fire Brigade or external VAD.

	EA0345	EA0346/7	EA0348/9	EA0350
Size (W x H)	170mm diameter	85mm x 30mm 150mm x 30mm	85mm x 30mm 150mm x 30mm	200mm x 75mm
Material	1.0mm PET	1.6mm Exterior Grade Acrylic	1.6mm Exterior Grade Acrylic	1.6mm Exterior Grade Acrylic
Colour	Black text White background	Black text White background	White text Red background	White text Red background
Text	2 x FIRE EVACUATE	FIRE/EVACUATE	FIRE/EVACUATE	FIRE
Font	15mm U65 Univers Bold TTF	15mm U65 Univers Bold TTF	15mm U65 Univers Bold TTF	50mm Sans Serif Bold TTF
Adhesive		3M 9086	3M 9086	1mm UHB Foam Tape

Fire Detection Product Catalogue

4906-9103 Wall Mount

Multi-Candela Strobe

4906-9104 Ceiling Mount



The 4906-910x Multi-Candela strobe is a high output xenon strobe capable of signalling evacuation using the ISO 8201 "T3" temporal pattern, as required by AS1670.4-2004 and AS 1670.1-2004. It produces white light with a link-selectable intensity of 15cd, 30cd, 75cd or 110cd. It is controlled by either the ISO 8201 Strobe Driver Module (PA1043) or a QE90 STRM Strobe Relay Module (PA0697).
Note: A 24V output cannot be used directly.

Specifications

Operating Voltage ¹	16-33Vdc (pulsed)
Average Current ²	41 to 164mA
Luminous Intensity ³	15 to 110 cd
Operating Temperature	0°C to +50°C
Relative Humidity	10% to 93% (non-cond.)
Dimensions (LWD)	121x75x67mm
Housing Colour	White
Strobe Light Colour	White (Clear)

Part Numbers

4906-9103	Wall Mount
4906-9104	Ceiling Mount

1. Voltage from PA1043 or PA0697. 2. Current depends on intensity 3. Selectable: 15, 30, 75, 110 cd



ISO 8201 Strobe Driver Module



The ISO 8201 Strobe Driver generates an ISO 8201 compliant "T3" pattern for the Multi-Candela strobe 4906-9104.

It connects directly to a supervised relay output of a fire alarm panel and drives one or more lines of strobes with a synchronised T3 pattern.

The fire alarm panel's output supervision supervises the wiring from the panel to the strobes. The output signals of up to 5 modules can be synchronised.

Four standoffis are supplied for mounting.

Specifications

Operating Voltage	17 - 30Vdc.
Operating Current	25mA.
Quiescent Current	Nil.
Output Strobe Current	2A max.
Dimensions	93 x 67 x 9.5 x 20 mm
Mounting Pattern (mm)	Ø4 x 4 holes, 83 x 57
Operating Temp	0°C to + 45°C
Relative Humidity	0% to 95% (non-cond.)
Indicators	On (Red) ¹
Part Number	PA1043

1. This LED will flicker in time with the output cadence

EA0301/2

EA0305/6

DLE201215A/R

ESS7010R



Specifications

Operating Voltage	24Vdc
Operating Current	80mA
Flash Rate	130 fpm
Flash Energy	0.6J
Ingress Protection	IP55
Dimensions	100 dia x 80 mm
Weight	160g

Part Numbers

EA0301	Amber AX-35
EA0302	Red AX-35



Specifications

Operating Voltage	24Vdc
Operating Current	400mA
Flash Rate	90 fpm
Flash Energy	3.15J
Ingress Protection	IP55
Dimensions	100 dia x 94 mm
Weight	230g

Part Numbers

EA0305	Amber
EA0306	Red



Specifications

Operating Voltage	24Vdc
Operating Current	600mA
Flash Rate	120 fpm
Luminous Intensity	100 Cd (Amber)
Operating Temp	-20°C to +55°C
Ingress Protection	IP65
Dimensions	160 dia x 175mm
Weight	450g

Part Numbers

DLE201215A	Amber
DLE201215R	Red



Specifications

Op. Voltage	20 to 28Vdc
Op. Current	250mA @24Vdc
Flash Energy	5J
Flash Rate	1Hz
Operating Temp	-25°C to +55°C
Relative Humidity	up to 90% (n/c.)
Ingress Protection	IP55
Dims (HWD)	86x86x83 mm
Weight	200g

Part Number

ESS7010R	
----------	--

Fire Detection Product Catalogue

EA0313

Specifications

Operating Voltage	20 to 30Vdc
Operating Current ¹	160mA
Flash Energy	2.6J
Operating Temp	-30°C to +60°C
Relative Humidity	10 to 95% (n/c.)
Dimensions (HWD)	250x150x80mm
Weight	450g
Part Number	EA0313

1. Ratings at 24Vdc, 5.6 Ohm, inrush limiting resistor fitted



Where two distinct visible signals are required, the VIGILANT EA0313 Dual Strobe unit is available. The dual strobes operate at 24 volts and provide a 2.6 Joule output. The strobes may be powered in tandem over a two wire circuit or independently over a 4 wire circuit.

40020B

Specifications

Operating Voltage	20 to 30Vdc
Operating Current ¹	140mA
Flash Energy	2.6J
Operating Temp	-5°C to +60°C
Relative Humidity	10 to 95% (n/c.)
Dimensions (HWD)	180x130x115mm
Mounting	Ø5.5x4, 150x100
Weight	450g

Part Numbers

40020B	Strobe & B/Box
40020	Strobe only

1. Ratings at 24Vdc, 5.6 Ohm, inrush limiting resistor fitted



The 40020B is designed to be mounted on a flat external wall. It is weather resistant and made of fire resistant ABS. Screws, caps and a back box is supplied.

Sounder / Beacon



Part Numbers

20-118	Sounder/Strobe, deep base (IP65)
576.501.224	Sounder/Strobe, shallow base (IP54) c/w tone sw
576.501.227	Sounder/Strobe, deep base, tone sw, sep. sound/strobe operation

Specification

Operating Voltage	18 to 30Vdc
Typical Current	68mA @ 24Vdc
Flash Energy	0.7 Joules
Flash Frequency	60 per minute
Tones	Roshni Tones 3 & 14
Sound Output	101dBA@1m
Volume Adjustment	0 to -20dB
Operating Temperature	-10°C to +55°C
Ingress protection	IP54/IP65
Dimensions (dia. x depth)	93 x 92 mm (shallow) 93 x 121 mm (deep)

A combined sounder and beacon which combines the features of the Roshni electronic sounder with a fully integrated Xenon beacon. These sounders are fully compatible with all Roshni tones. They are available in red, with red lens. There are two versions available: A Shallow Base (International Protection Rating IP54) and a Deep Base (International Protection Rating IP65).

Multi-Tone Sounder

Mounting Bracket



576.501.060 IP45 Multi-Tone Sounder

Specifications

Operating Voltage	9 to 30Vdc
Operating Current	27mA (24Vdc - ISO 8201 T3)
Sound Pressure Level	109 dB(A) (T3 tone)
Dimensions(Dia x H)	90x75 mm
Operating Temp	-40°C to +70°C
Ingress Protection	IP45
Part Number	576.501.060



576.501.062 IP66 Multi-Tone Sounder

Specifications

Operating Voltage	9 to 30Vdc
Operating Current	27mA (24Vdc - ISO 8201 T3)
Sound Pressure Level	109 dB(A) (T3 tone)
Dimensions(Dia x H)	90x96 mm (deep base)
Operating Temp	-40°C to +70°C
Ingress Protection	IP66
Part Number	576.501.062



Part Number
576.501.047

Beacon/Sounder
Mounting Bracket

ESS711XR



Specifications

Op Voltage	ESS711XR 24Vdc
Op Current	270mA
Dims (mm)	Ø165 x 246
Protection	IP67
Material	Aluminium
Approval	CENELEC EExdIICT4
Part Number	ESS711XR

The ESS711XR is a CENELEC approved EEx d IIC T4, IECEx EEx d T5 device that is capable of automatically synchronising its flash rate with other adjacent beacons. The flash intensity is rated at 5 Joules. It features an adjustable stainless steel mounting bracket and is rated to IP67. IECEx Certificate SIM 04.0002.

ESS7010ISx

Specifications

Op. Voltage	10 to 28Vdc ¹
Op. Current	25mA @24Vdc
Flash Energy	5J
Flash Rate	120 fpm
Operating Temp	-40°C to +60°C
Relative Humidity	up to 90% (n/c.)
Ingress Protection	IP56
Dims (HWD)	86x86x93 mm
Weight	400g
IECEX Certificate	SIR04.0039X

Part Numbers

ESS7010ISA	Amber Lens
ESS7010ISR	Red Lens

1. Via suitable barrier



ESS7010ISR shown above

The ESS7010ISx is an EExia rated LED warning light. It is rated IECEx EExia IIC T4, ATEX certificate ITS02ATEX2006, IECEx certificate SIR04.0039X.

Ex Rated 100V Line Speaker 20W



HP-20EExIIN(T) - 20W
EX II GD Zone 22
EEx nA II T3 / Nemko 03ATEX3568

Specifications	
Line Voltage	100V
Power Rating	20W
Power Taps	1.5,2,5,6,10,20
SPL 1W/1m	110 dB
SPL @ rated power	122dB
Eff. freq. range(Hz)	310 to 8000
Dispersion (-6dB 1&4kHz)	115° / 30°
Material	Polyamide
Weight	2.3 kg
IP-rating	IP67
Ambient Temp	-50 to +150°C
Dimensions (dia x L)	237 x 286mm
Approval	IECEX
NEMKO/ Ex de IIB+H2 T4 / Ex 81218	
Part Number	HP-20EEXIIN(T)

EA0013 - 10W



EA0013

This ABS horn speaker is suitable for distributed paging systems. A 22µF bipolar isolation capacitor, and adjustable power tap switch is provided, as is a 4-core loop-through flying lead.

100V Line Horn Speaker

Specifications	EA0013	EA0016
Line Voltage	100V	100V
Power Rating	10W	20W
Power Taps (W)	1.25,2.5,5,7.5,10	5, 7.5,10, 20
SPL 1W/1m	104 dB	108 dB
SPL @ rated power		114 dB 121 dB
Freq. Resp.(Hz)	480 to 10k	275 to 10k
Line Monitoring Cap.	22µF Bipolar	
Dispersion Angle	110°	70°
Material	UV stable ABS	
Weight	1.8 kg	2.6 kg
IP-rating	IP66	IP66
Operating Temp.	-20 to +55°C	-25 to +70°C
Dims (dia x L)	180x255mm	212 x 285mm
Part Numbers	EA0013	EA0016

EA0016 - 20W



EA0016

This ABS horn speaker is suitable for distributed paging systems. A 22µF bipolar isolation capacitor, and adjustable power tap switch is provided, as is a 4-core loop-through flying lead.

EA0017 100V Line 30W Horn Speaker



This IP66 rated weatherproof horn speaker is ideal for indoor or outdoor use. It features marine grade aluminium mounting bracket and stainless steel fixings, making it ideal for use in marine environments, on board drilling rigs, ships, industrial plants and other areas of harsh environments. The EA0017 will also endure extreme temperature variations. The UV stabilised ABS construction, coupled with the aluminium mounting bracket and stainless steel fixings make it the first choice for use in outdoor & marine applications.

Specifications	
Power Rating	30W
Power Taps	3.75,7.5,15,30W
Sound Pressure Level	109dB 1W @ 1m
Frequency Response	330Hz to 8kHz
Dispersion Angle	130°
Dimensions (dia x L)	238 x 287 mm
Weight	2.6 kg
Operating Temperature	-20°C to +55°C
Ingress Protection	IP66
Part Number	EA0017

EA0020 8 Ohm 10W Horn Speaker



The EA0020 is a high performance 8 ohm horn speaker for use in smaller PA applications requiring a low impedance audio solution. It is ideal for use as an external sounder for the VIGILANT IP65 AVI Mk2 where increased warning tone volume is required. The EA0020 should be mounted adjacent to the IP65 AVI Mk2. The cable supplied with the speaker should enter the AVI using the supplied 16mm cable glands and be terminated at the AVI Controller board.

Specifications	
Impedance	8 Ohm
Power rating	10W
SPL 1W@1m	104dB
Frequency Response	340Hz to 10kHz
Dispersion Angle	110°
Dimensions (dia. x D)	180 mm x 230 mm
Weight	1kg
Material	ABS
Operating Temp.	-20°C to +55°C
Relative Humidity	10 to 95% (non-cond.)
Ingress Protection	IP65
Part Number	EA0020

C2052 Wurli-Gig™ Horn Speaker Mount



It is no longer necessary to use solid wall fasteners costing around \$2ea (i.e. \$4 per horn). The Wurli-Gig™ is designed to be installed with standard 50mm green wall plugs and 8G self tappers costing only cents. The Wurli-Gig™ can save installation labour by up to 70%, & drastically reduce the money spent on fasteners.

Specifications	
Colour	Grey
Material	ABS, UV stabilised
Dimensions (HWD)	120 x 50 x 40 mm
Part Number	C2052

Fire Detection Product Catalogue

EA0005/8 'One Shot' 100V Line Speaker



The 'One Shot' PA speaker and grille is designed to install easily into 10 to 13mm gyprock/plaster/acoustic ceilings. Simply drill the required size hole, terminate the wiring and push the speaker into the ceiling until it snaps into place. They are designed to meet the requirements of AS 2220.1, with a transformer cover (not shown in the image) and 22µF capacitor. The transformer has 5 power taps from 0.33 to 5W and a 4 way terminal block.

Specifications	EA0005	EA0008
Line Voltage	100V	
Power Rating	5W	
Power Taps (W)	0.33,0.66,1.25,2.5,5	
SPL 1W/1m	92 dB	93 dB
Freq. Resp.(Hz)	100 to 15k	
Monitoring Cap.	22µF Bipolar	
Operating Temp.	-20 to +55°C	
Ceiling Cutout	140mm	246mm
Mounting Depth	105mm	75mm
Dims (mm)	ø159x112H	ø265x85H
Weight	606g	960g
Part Numbers	EA0005	EA0008

EA0006/7 - 100V Line Ceiling Recessed Speakers



EA0006 Speaker



Speaker Grille



EA0007 Speaker

Specifications - EA0006

Power Rating	10W rms
Driver Impedance	8 Ohm
Power Taps	0.33, 0.5, 1, 2.5, 5W
Sound Pressure Level	92dB 1W @ 1m
Frequency Response	75Hz to 20kHz @-6dB
Line Voltage	100V
Directivity @ 2kHz	160°
Ceiling Cutout	103mm diameter
Dimensions	100mm diameter
Part Numbers	
EA0006	Speaker 100mm
EA0102	Grille (155mm OD)
EA0104	Screw Covers pkt 80

The Johnson Controls EA0006 and EA0007 speakers feature a tapped line transformer with cover, 5 position terminal strip and line supervisory capacitor. EA0006 is a 100mm diameter cone speaker suitable for concealed mounting in ceilings. EA0007 is a 200mm diameter cone speaker suitable for recessed mounting. Both speakers comply with the electrical safety requirements of AS 60950.

Specifications - EA0007

Power Rating	10W rms
Driver Impedance	8 Ohm
Power Taps	0.33, 0.5, 1, 2.5, 5W
Sound Pressure Level	93dB 1W @ 1m
Frequency Response	50Hz to 20kHz @-6dB
Line Voltage	100V
Directivity @ 2kHz	140°
Ceiling Cutout	205mm diameter
Dimensions	200mm diameter
Part Numbers	
EA0007	Speaker 200mm
EA0101	Grille (250mm OD)
EA0104	Screw Covers pkt 80

EA0025 'One-Shot' 100V Line Speaker - AS 7240.24



The 'One-Shot' PA speaker and grille is designed to install easily into 10 to 13mm gyprock/plaster/acoustic ceilings. Simply drill the required size hole, terminate the wiring and push the speaker into the ceiling until it snaps into place. They are designed to meet the requirements of AS ISO7240.24, with a cover and 22µF capacitor. The transformer has 5 power taps from 0.33 to 5W and a 4 way wire-protected terminal block.

Specifications

Power Rating	5W
Power Taps	0.33, 0.66, 1.25, 2.5, 5W
Sound Pressure Level	90dB 1W @ 1m
Frequency Response	100Hz - 15kHz
Ceiling Cutout	140mm diameter
Mounting Depth	117mm (incl ceiling tile)
Dimensions (mm)	159 dia. (grille) x 122H
Ambient Temperature	-25°C to +55°C
Weight	700g
ActivFire Listed	afp-3199
Part Numbers	
EA0025	One-Shot Speaker
EA0034	Ceiling tile support pan
EA0035	Ceiling tile sprt split ring

EA0027 100V Line 30W Horn Speaker - AS 7240.24



The EA0027/28 range of one-shot horn speakers have been engineered to meet the requirements of evacuation and occupant warning systems. The high efficiency speaker and transformer combination ensures high Sound Pressure Level, wide frequency response, superior speech intelligibility and reproduction for fire alarm and evacuation warning systems. All components of the fixture are manufactured from high quality, long lasting, flame retardant material and tested to AS ISO7240.24:2015. On-site installation is simple and straight forward with oversized cable glands and terminal block. With a patented twist lock rear cover and the patented 'dog leg' bracket, substantial labour cost savings may be achieved.

Specifications

Power Rating	10W
Power Taps	1.25,2.5,5,7.5,10W
Sound Pressure Level	98dB 1W @ 1m
Frequency Response	250Hz to 10kHz
Dispersion Angle	130°
Dimensions (dia x L)	180 x 275 mm
Weight	1.8 kg
Operating Temperature	-25°C to +55°C
Ingress Protection	IP66
ActivFire Listed	afp3200

Part Numbers

EA0027	10W Horn - White
EA0028	10W Horn - Black

*Active Equalisation is required for AS 7240.24 compliance.

EA0029 'One Shot' 100mm 100V Line Surface Mount Speaker - AS 7240.24



EA0029 is designed to mount directly to the underside of concrete slabs or inaccessible ceilings. The housing is surface mounted with concealed internal fixings. Speaker cable entry can be either from the rear, or via surface mounted conduit (four 19mm conduit knockouts are provided).

The speaker is fitted with a 100V line transformer tapped at 0.33, 0.66, 1.25, 2.5 and 5W and includes 4 way wire protected terminal strip and a 22µF bipolar capacitor for line monitoring.

This speaker features 'One-Shot' design, simply snap-fits in seconds to the surface mounting ring, reducing installation time considerably. It is tested to AS 7240.24 and listed as compliant.

Specifications

Power Rating	5W
Power Taps	0.33, 0.66, 1.25, 2.5, 5W
Sound Pressure Level	95dB 5W @ 1m
Frequency Response	100Hz - 15kHz
Operating Temp.	-25°C to +55°C
Relative Humidity	up to 95% (non-cond.)
Dimensions	210 dia. x 67H mm
Weight	810g
<i>Indoor Applications Only</i>	
ActivFire Listed	pending

Part Numbers

EA0029	Surf Mnt Spkr - White
EA0030	Surf Mnt Spkr - Black



Step 1: Secure Housing to Mounting Surface



Step 2: Terminate Cable



Step 3: Fit Speaker to Housing

EA0031/32 'One Shot' 200mm 100V Line Surface Mount Speaker - AS 7240.24



EA0031/33 are designed to mount directly to the underside of concrete slabs or inaccessible ceilings. The housing is surface mounted with concealed internal fixings. Speaker cable entry can be either from the rear, or via surface mounted conduit (four 19mm conduit knockouts are provided).

The speakers are fitted with a 100V line tapped transformer and includes 4 way wire protected terminal strip and a 22µF bipolar capacitor for line monitoring. These speakers feature the 'One-Shot' design, simply snap-fit in seconds to the surface mounting ring, reducing installation time considerably.

They are designed to meet AS 7240.24:2015.

Specifications

Specifications	EA0031/32	EA0033
Line Voltage	100V	
Power Rating	5W	15W
Power Taps (W)	0.3,0.6,1.2,2.5,5	1.2,2.5,5,10,15
SPL 1W/1m	92 dB	95 dB
Freq. Resp.(Hz)	100 to 15k	80 to 12k
Monitoring Cap.	22µF Bipolar	
Operating Temp.	-20 to +55°C	
Dims (mm)	ø310x85H	ø310x85H
Weight	1.36kg	1.36kg
<i>Indoor Applications Only</i>		
ActivFire Listed	afp-3295	pending
Part Numbers		
	EA0031 (wht)	EA0033
	EA0032 (blk)	

EA0036/37 'One Shot' 100mm 100V Line Surface Mount Speaker - AS 7240.24



EA0036/37 are a low profile version of EA0025 - ceiling mount speakers certified to the AS ISO7240.24 standard for fire & evacuation announcements in buildings. Each speaker is fitted with a fire retardant speaker/transformer dome and is fitted with oversized cable glands and terminal blocks for easy on site termination. These speakers feature the 'One-Shot' design, simply snap-fit in seconds to the surface mounting ring, reducing installation time considerably. The speakers are fitted with a 100V line tapped transformer and includes 4 way wire protected terminal strip and a 22µF bipolar capacitor for line monitoring.

Specifications

Line Voltage	100V
Power Rating	5W
Power Taps (W)	0.3,0.6,1.2,2.5,5
SPL 1W/1m	89 dB
Freq. Resp.(Hz)	100 to 15k
Monitoring Cap.	22µF Bipolar
Operating Temp.	-20 to +55°C
Dims (mm)	ø159 x 65H
Ceiling Cutout	ø140
Mounting Depth	117mm (incl ceiling tile)
Weight	710kg
<i>Indoor Applications Only</i>	
ActivFire Listed	pending
Part Numbers	
	EA0036 (white)
	EA0037 (black)

100V Line Audio Attenuators



These 100V line audio attenuators install in a standard electrical flush box or mounting block. Screwdriver terminals enable a simple and neat connection. Models for 10W, 40W and 100W have an override relay facility. With fire evacuation systems it is necessary to override the attenuator setting to broadcast an announcement at full volume. The override relay requires 24Vdc to allow the attenuator to operate normally. This 24Vdc can be provided from the QE90 Amplifier Transformer Relay Output.

Specifications

Power Rating (100V line)	10 W	40 W	100 W
Attenuation (dB)	0 to 26.3	0 to 26.3	0 to 33
Relay Override			
Operation Voltage	24Vdc typical		
Wall Box Size	1 gang	1 gang	2 gang
Part Numbers	A2260	A2255	A2339

GX93 Mini Horn Sounder



The GX93 is ideal for applications where a dependable alarm signal is required in hotels, dormitories, apartments, and other installations.

The unit is shipped with link J1 inserted for ISO 8201 T3 Temporal pattern tone. Remove J1 for continuous horn signal. The GX93 is intended for indoor installation only. This appliance is not weather-proofed for outdoor applications.

The GX93 is available in red or white versions.

* The sound output for the Temporal 3 tone is rated lower; the time the horn is off is averaged into the sound output rating. While the horn is producing a tone in the Temporal 3 mode its sound pressure is the same as the continuous mode.

Specifications

Operating Voltage	8 to 33Vdc
Alarm Current	22mA (24Vdc)
Sound Pressure Level	
Continuous Tone	77 to 85dB @ 3m
Temporal 3 Tone	75 to 81dB @ 3m*
Operating Temp.	0 to +49°C
Dimensions	
GX-93R	122x53x19mm (HWD)
GX-93W	114x72x13mm (HWD)

Part Numbers

GX93R	Red Mini Horn Sounder
GX93W	White Mini Horn Sounder

FP1135 T-Gen2 Isolation Amplifier



The FP1135 T-Gen2 Isolation Amplifier connects to an existing 100V speaker line and reproduces this signal at up to 60W load on a separate supervised 100V line. It is suitable for use with speech and music as well as with warning tones. The 100V output line from the amplifier is electrically isolated from the input 100V line, so noise or other signals on the output line are kept separate and do not affect the input line.

The Isolation Amplifier requires a nominal supply of 27Vdc, either from an existing supply, or a dedicated mains-powered supply.

To support a full 60W load, a 5A PSU is required, such as the FP0804.

Specifications

Supply Voltage	19.6V to 28.8Vdc
Quiescent Current	170mA ¹
Active Current	3A (60W @ 27Vdc)
Input Signal	100V rms @ 1W max.
Output Voltage	100V rms
Output Power	60W rms ²
Dimensions (HWD)	295x240x80 mm

Part Numbers

FP1135	Isolation Amplifier
FP0804	24V 5A PSU
FP0766	24V 2A PSU (40W max.)

1. No speech or background music
2. Tones and Speech/music

SIM-Mk2 Speaker Isolation Module



To prevent PA loudspeakers in a secure area from being used as microphones, the Speaker Isolation Module SIM-Mk2 is installed within the secure area between an incoming 100V speaker circuit and the speakers to be secured.

Specifications

Supply Voltage	18V to 28Vdc
Quiescent Current	35mA
Active Current	70mA (max.)
Input Signal	100V Line Input
Output Voltage	100V
Operating Temp	0°C to +50°C
Dimensions (HW)	90.5x76.5 mm

Part Number

SIM-MK2-V

Bell Monitor

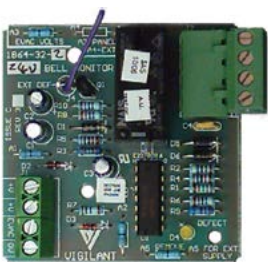

The Bell Monitor 1864-32 is a small module designed to provide open and short circuit fault (defect) supervision of an evacuation circuit of an automatic fire alarm system, as required by NZS 4512 and AS 1670.1. It can be used to supervise the evacuation circuit wiring of older fire alarm panels that do not have this capability built in. Also, because it contains its own evacuation circuit relay, it can be used to extend or increase the evacuation load capability of fire alarm panels that already have built in evacuation wiring supervision.

Specifications

Operating Voltage	24V±20%
Operating Current	4mA (8mA LED on)
Evac cct sup current:	1.3mA
Evac cct sup voltage:	13V ²
Evac sys voltage ³	30Vdc max.
Evac sys current	5Adc resistive max.
Dimensions (HWD):	62 x 62 x 29 mm
FPANZ Listing	VF/606

Part Number

PA0494

2. Across 10k EOL
3. If separate from panel

200mm Motorised Bell



Features

- CE marked
- Low cost
- Extra high 94dBa/m
- Slim profile (53mm)
- Fully suppressed and polarised
- Quick and easy to install
- Back Box ordered separately

Specifications

Operating Voltage	24Vdc
Rated Current	60mA @ 24Vdc
Sound Output	95dBA @ 1m
Operating Temp	-10°C to +50°C
Colour	Red
Weight	1420g

Part Numbers

BELL01	200mm Bell
BELL02	Bell Back Box - Red

Audio Visual Indicators (AVI)



FP1037 with FP0853 AVI MK2 2 LINE RED shown with FA2700 and FA2701 Faceplates respectively

Specifications

	Indoor AVIIP65 AVI
Op. Voltage	19 to 28Vdc
Current (@24Vdc)	
Supervision	2µA max.@ 25°C
1 Line & tone	45mA
2 Lines & tone	62mA
3 Lines & tone	80mA
4 Lines & tone	97mA
Luminance	300cd/m2 - 1Hz Flash
Sound Pressure	90dBA @1m 75dBA@1m
Dims (HWD) (mm)	206x316x85 280x280x132
Operating Temp.	0°C to +50°C
Rel. Humidity	Up to 95% (non cond.)
IP Rating	IP30 IP65
Weight (Housing)	2kg 5kg
Weight (f'plate)	0.25kg 0.25kg
Designed to comply with	AS1603.11
FPANZ Listed	VF/417

Part Numbers

FP0853	AVI Mk2 2 line red
FP0854	AVI Mk2 3 line yellow
FP1037	IP65 AVI Mk2 2-line red
FP1038	IP65 AVI Mk2 3-line yellow
EA0020	IP65 8 ohm 10W Horn Speaker
KT0292*	Exp Kit: red LED PCB + hardware
KT0293**	Expansion Kit: red double sided
FA2700	Fire Alarm, Evacuate Area, 2-line Red UV-stable
FA2701	Fire Alarm, Do Not Enter, 2-line Red UV-stable
FA2702	Do Not Enter, CO2 Gas Discharged, 3-line Red UV-stable
FA2703	Do Not Enter, FM-200 Gas Discharged, 3-line Red UV-stable
FA2704	Do Not Enter, INERGEN Gas Discharged, 3-line Red UV-stable
FA2710	Warning, Fire Door Closing, 3-line Red UV-stable
FA2776	Extinguishing System Inoperative, 3-line Yellow UV-stable

*adds a 3rd LED board to make 3 line red sign
 ** adds 2nd cover & base with 2 LED boards for ceiling mounted double sided 2 line red sign
 (Other faceplate legends available to special order)

The AVI Mk2 is an illuminated warning sign that produces distinct audible and visual indication of an emergency. It is designed for use with fire alarm or gaseous fire extinguishing systems, or other applications where clear audio-visual warning is required. On activation, the AVI's internal LEDs illuminate the lettering on the 2 or 3 line sign faceplate/s and the internal loudspeaker produces either ISO 8201 or AS 2220 audible warning signals. The internal speaker has a link selectable Quiet option that reduces the tone volume by 10dB. The IP65 model comprises an indoor AVI mounted inside a UV-resistant IP65 enclosure with a transparent lid. A range of high visibility UV-resistant faceplates is available.

Configuration Options

Illumination of the top and bottom sign sections and selection of the tones to be used is field programmable using internal links. This way, the AVI can readily display either two-stage or alternate warnings. Up to four lines of text may be accommodated on the faceplate, although use of two or three lines is standard. For situations with low ambient light, the sign illumination can be reduced by removing a resistor in each LED Board driver. This also reduces current consumption. Expansion options include an LED board kit to convert a red 2-line unit to 3-line and a back-box kit to expand a red 2-line unit to ceiling mounted, double sided format. Several AVIs may be synchronised by connecting the 'Sync' terminals (an additional wire is required between units).



FP0854 AVI MK2 3 LINE YELLOW



KT0292 AVI MK2 EXPANSION RED LED PCB & HARDWARE



KT0293 AVI MK2 RED DOUBLE SIDED EXPANSION KIT



FA2700 AVI MK2 FACIA & DIFFUSER, FIRE ALARM, EVACUATE AREA



FA2701 AVI MK2 FACIA & DIFFUSER, FIRE ALARM, DO NOT ENTER



FA2702 AVI MK2 FACIA & DIFFUSER, DO NOT ENTER, CO2 DISCHARGED



FA2703 AVI MK2 FACIA & DIFFUSER, DO NOT ENTER, FM-200 GAS DISCHARGED



FA2704 AVI MK2 FACIA & DIFFUSER, DO NOT ENTER, INERGEN GAS DISCHARGED

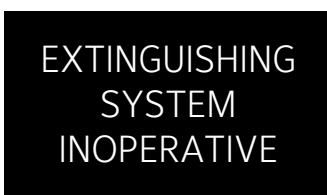

FA2776 AVI MK2 FACIA & DIFFUSER, EXTINGUISHING SYSTEM INOPERATIVE



FA2710 AVI MK2 FACIA & DIFFUSER, WARNING FIRE DOOR CLOSING

Batteries and Power Supplies

Batteries

Part Number	Model No.	Voltage (V)	Ah	Dimensions (mm)			Weight (kg)	ActivFire Listing	These rechargeable batteries are lead-lead dioxide systems. The dilute sulphuric acid electrolyte is suspended and thus immobilised. Should the battery be accidentally overcharged producing hydrogen and oxygen, special oneway valves allow the gases to escape thus avoiding excessive pressure build-up. Otherwise, the battery is completely sealed and is, therefore, maintenance-free and leak proof.
				Length	Width	Height			
PS1212	CJ12-1.3	12	1.3	97	43	58	0.61	afp-1636	
PS1270	CJ12-7	12	7	150	65	101	2.8	afp-1636	
PS12120	CJ12-12	12	12	151	98	101	4.7	afp-1636	
PS12180	CJ12-17	12	18	181	77	168	6.0	afp-1636	
PS12260	CJ12-26	12	26	175	165	125	9.0	afp-1636	
PS12330	CJ12-33	12	33	195	135	180	10.5	afp-1636	
PS12400	CJ12-40	12	40	197	166	170	13.7	afp-1636	
PS12650	CJ12-65	12	65	355	167	183	22.7	-	
PS12750	CJ12-75	12	75	259	168	208	23	-	
PS12850	CJ12-85	12	85	305	168	212	26.5	afp-1636	
PS121000	CJ12-100	12	100	331	173	221	31	afp-1636	

24Vdc Power Supplies for QE90/MX4428/4100

PSU2406 and PSU2412 power supplies feature combined power supply and constant voltage, temperature compensated, battery charging facilities to suit QE90 evacuation systems and MX4428/F4000 fire indicator panels.

The range of models includes 5 Amp in 19" rack mounting (2U) or gear-plate mounting (brick) and 10 Amp in 19" rack mounting (2U). Informative LEDs provide diagnostic indications for ease of servicing. A green LED on the front panel indicates operation and its flash cadence indicates current loading.

A yellow LED provides fault indication with the flash cadence identifying the fault type. The power supplies require a mains power input of 230V 50Hz. The power supplies are respectively rated for 5A and 10A continuous, with 6A and 12A peak loads for a short duration respectively.



ME0330 - 24Vdc 5A Brick (QE90)
ME0334 - 24Vdc 5A Brick (MX4428)



ME0333 - 24Vdc 10A (QE90-PSU2412)
 (Pictured above, supplied with 2 circuit breakers, and 2 blanked circuit breaker positions)
ME0331 - 24Vdc 5A (QE90)
 (supplied with 1 switch and 1 circuit breaker, no blank positions)



ME0340 - 24Vdc 5A (MX4428)
ME0343 - 24Vdc 10A (MX4428-PSU2412F)

Specifications	2406	2412
Output	24Vdc 5A	24Vdc 10A
19" Rack Type		
Dimensions (mm HWD)	89x483x123	89x483x185
Weight		5.5kg
Brick Type		
Dimensions (mm HWD)	96x262x158	
Weight	5kg	
ActivFire Listed	afp-1290	
Part Numbers		
19" Rack Type		
QE90	ME0331	ME0333
MX4428	ME0340	ME0343
Brick type		
QE90	ME0330	
MX4428	ME0334	
Accessories		
50A Circuit Breaker (replacement)	SW0142	
Circuit Breaker Kit (additional)	KT0546	

4100 - ME0470 24Vdc 5A 4100 Power Supply



An auxiliary 24V 5A PSU (part code 4100-ME0470) is available for Simplex 4100 series (4100, 4100A, 4100U, or 4100ES) fire alarm panels to provide additional power supply capacity. It mounts in the 4100 equipment bay, occupying two legacy card spaces. It can be used as a standalone supply in an RTU, or to augment the FIPs System Power Supply.

Specifications	
Output	27.3Vdc 5A
Input	230Vac 50Hz
Heat Dissipation	40W
Operating Temp.	-5°C to +45°C
Relative Humidity	10% to 95% non-cond.
Dimensions (HWD)	290x90x145mm
Part Number	4100-ME0470

FP0804 24Vdc 5A MX4428 Power Supply



FP0804 comprises a power supply for MX4428 mounted within the FP0576 8U battery box which has a similar finish to the range of standard VIGILANT 19" rack cabinets.

The cabinet provides IP51 protection and the door is secured with a 003 lock.

Specifications

Output	24Vdc 5A
Input	230Vac 50Hz
Battery Capacity	40Ah
Dimensions (HWD)	440x550x211mm
Cabinet	1.6mm mild steel, powder coat cream wrinkle
Ingress Protection	IP51
Part Number	FP0804

FP0766 PSU1948 24Vdc 2A Power Supply



Series 1948 Power Supplies are designed specifically for use in fire alarm systems. They provide a compact, self-contained 24 volts dc mains power supply. Their built-in facilities to monitor the charging voltage and battery capacity make them ideal for powering brigade signalling equipment, detectors, warning devices and ancillary equipment. If the charging voltage or battery capacity becomes low they activate a warning indication and output. Sealed lead-acid batteries may be purchased separately.

Specifications

Output	24Vdc 2A
Input	230Vac 50Hz
Battery Capacity	2x 6.5Ah
Dimensions (HWD)	295x240x80mm
ActivFire Listed	afp-1341
FPANZ Listed	VF/629
Part Number	FP0766

FP0852 PSU1948 24Vdc 2A 'VESDA' Power Supply



This Series 1948 Power Supply is designed match the VESDA LaserPLUS and LaserSCANNER detectors in size and colour. The FP0852 provides a compact, self-contained 24 volts dc mains power supply, with built-in facilities to monitor the charging voltage and battery capacity. make them ideal for powering brigade signalling equipment, detectors, warning devices and ancillary equipment. If the charging voltage or battery capacity becomes low they activate a warning indication and output. Sealed lead-acid batteries may be purchased separately.

Specifications

Output	24Vdc 2A
Input	230Vac 50Hz
Battery Capacity	2x 12Ah
Dimensions (HWD)	230x360x130mm
ActivFire Listed	afp-1341
FPANZ Listed	VF/629
Part Number	FP0852

MX4428 24Vdc 5A Power Supply



The 5A ME0476 Power Supply is a direct replacement for older 2.5A FP0874/FP0825 supplies. The ME0476 is used in MX4428 panels (or F4000 upgraded to V3.10+ software).

For AS1603.4 F4000 panels, the 5A FP0882K replaces FP0474. It has the battery test resistors required by AS1603.4.

Both supplies feature a 3 pin GPO, replacing the metal mains cover & panel mount mains switch.

Specifications

Output	24Vdc 5A
Input	230Vac 50Hz
ActivFire Listed	afp-1341
FPANZ Listed	VF/629
Part Numbers	
ME0476	MX4428 24Vdc 5A PSU
FP0882K	F4000 24Vdc 5A PSU (AS 1603.4)

Door Holders & Accessories

EA0405 Door Holder Release



The EA0405 Electromagnetic Door Holder Release is designed to allow fire and smoke doors to be opened manually. A standard switch plate mounting is used. A momentary action switch de-energises the door holder allowing the door to open.

Specifications	
Operating Voltage	12/24Vdc
Maximum Current	12A
Operating Temp	0 to 60°C
Relative Humidity	95% (non-cond.)
Cable Termination	4x1.5mm ²
Dimensions	74x118x30mm
Part Number	EA0405

SU0613 Emergency Door Release – Single Pole



The SU0613 Manual Call Point has a plastic coated frangible element to ensure safe and reliable operation, producing no dangerous glass shards. It is operated by simply pressing on the centre of the frangible element until it snaps. A hammer or other impact device is not required. The snapped frangible element releases a single pole microswitch. The SU0613 is a surface mounting, white MCP that includes a white back box to house the terminations. It is fitted with a green label carrying the words EMERGENCY DOOR RELEASE in white text. Switch function (NO/NC) is determined by the position of the terminal block.

Specifications	
Max Current @ 30Vdc	Resistive 8A Inductive 3A
Contact Resistance	100mOhm. (max.)
Switch	Single Pole
Operating Temp	0 to 60°C
Relative Humidity	95% (non-cond.)
Dimensions	87x87x52 mm
Legend	Emergency Door Release
Part Numbers	
SU0613	BGA
515.001.025	Spare Glass (pk 5)

SU0614 Emergency Door Release – Double Pole



The SU0614 Manual Call Point has a plastic coated frangible element to ensure safe and reliable operation, producing no dangerous glass shards. It is operated by simply pressing on the centre of the frangible element until it snaps. A hammer or other impact device is not required. The snapped frangible element releases a double pole microswitch. The SU0614 is a surface mounting, white MCP that includes a white back box to house the terminations. It is fitted with a green label carrying the words EMERGENCY DOOR RELEASE in white text. There are 2 terminal blocks for connection. Switch function (NO/NC) is determined by the terminals used.

Specifications	
Max Current @ 30Vdc	Resistive 8A Inductive 3A
Contact Resistance	100mOhm. (max.)
Switch	Double Pole
Operating Temp	0 to 60°C
Relative Humidity	95% (non-cond.)
Dimensions	87x87x52 mm
Legend	Emerg. Door Release
Part Numbers	
SU0614	DP BGA
515.001.025	Spare Glass (pk 5)

FP0101 Electromagnetic Door Holder



The FP0101 Electromagnetic Door Holder is designed to hold fire and smoke doors open under normal conditions, but automatically close under their own spring return mechanism when a fire or smoke alarm system is activated. The door is held open by the magnetic force between an electromagnet mounted on the wall behind the door and a steel keeper plate mounted on the back of the door. When the electromagnet is de-energised, the door automatically closes. Alternatively the door can be manually released by pressing the button on the magnet base.

Specifications	
Operating Voltage	24Vdc ± 20%
Operating Current	50mA nominal
Operating Temp	0 to 60°C
Relative Humidity	95% (non-cond.)
Cable Termination	2x1.5mm ²
Holding Load	25kg nom. @24V, 20°C
Dimensions	
Magnet	118x74x27mm
Plate	75 dia x 23mm
Weight	600g
Part Number	FP0101

EA0407 Electromagnetic Door Holder 150mm



The EA0407 Electromagnetic Door Holder is designed to hold fire and smoke doors open under normal conditions, but automatically close under their own spring return mechanism when a fire or smoke alarm system is activated. The door is held open by the magnetic force between an electromagnet mounted on the wall behind the door and a keeper fixed to the back of the door. When the electrical supply to the electromagnet is interrupted, the door automatically closes.

Specifications	
Operating Voltage	24Vdc ± 20%
Operating Current	50mA nominal
Operating Temp	0 to 60°C
Relative Humidity	95% (non-cond.)
Cable Termination	2x1.5mm ²
Holding Load	25kg nom. @24V, 20°C
Dimensions	150mm
	75 dia x 23mm (Plate)
Part Number	EA0407

Electromagnetic Door Holders 300/385mm



The EA0408 Electromagnetic Door Holder is designed to hold fire and smoke doors open under normal conditions, but automatically close under their own spring return mechanism when a fire or smoke alarm system is activated.

The door is held open by the magnetic force between an electromagnet mounted on the wall behind the door and a keeper fixed to the back of the door. When the electrical supply to the electromagnet is interrupted, the electromagnet is de-energised and the door automatically closes.

Specifications	
Operating Voltage	24Vdc ± 20%
Operating Current	50mA nominal
Operating Temp	0 to 60°C
Relative Humidity	95% (non-cond.)
Cable Termination	2x1.5mm ²
Holding Load	25kg nom. @24V, 20°C
Dimensions	300mm 75 dia x 23mm (Plate)

Part Numbers	
EA0408	300mm Straight
EA0414	385mm Straight

EA0409 Floor Mount Door Holder

35771 Door Holder and Keeper Set



Door Holder Box

The EA0409 Floor Mount Door Holder comprises of a Box and Door Holder that will retain a load of 25kg. The Box provides a convenient attractive cover protecting the door holder from accidental damage.



17295/30 30° Anvil (Keeper Plate)

Specifications	
Operating Voltage	24Vdc
Holding Load	40kg nom. @24V, 20°C
Dimensions (HWD)	120x85x70mm
Weight	550g
Finish	Cream Wrinkle Powder Coat

Part Numbers	
EA0409	Kit (box, holder & keeper)

Spares	
35771	Door Holder & Keeper set
17295/30	30° Anvil (Keeper Plate)

EA0410 Electromagnetic Door Holder 150mm 90°



The EA0410 Electromagnetic Door Holder is designed to hold fire and smoke doors open under normal conditions, but automatically close under their own spring return mechanism when a fire or smoke alarm system is activated. The door is held open by the magnetic force between an electromagnet mounted on the wall behind the door and a keeper fixed to the back of the door. When the electrical supply to the electromagnet is interrupted, the electromagnet is de-energised and the door automatically closes.

Specifications	
Operating Voltage	24Vdc ± 20%
Operating Current	50mA nominal
Operating Temp	0 to 60°C
Relative Humidity	95% (non-cond.)
Cable Termination	2x1.5mm ²
Holding Load	25kg nom. @24V, 20°C
Dimensions	150mm 75 dia x 23mm (Plate)
Part Number	EA0410

Electromagnetic Door Holders 300/450mm 90°



The EA0411 Electromagnetic Door Holder is designed to hold fire and smoke doors open under normal conditions, but automatically close under their own spring return mechanism when a fire or smoke alarm system is activated. The door is held open by the magnetic force

Specifications	
Operating Voltage	24Vdc ± 20%
Operating Current	50mA nominal
Operating Temp	0 to 60°C
Relative Humidity	95% (non-cond.)
Cable Termination	2x1.5mm ²
Holding Load	25kg nom. @24V, 20°C
Dimensions	300mm 75 dia x 23mm (Plate)
Part Numbers	
EA0411	EA0411
EA0413	300mm 90 Deg 450mm 90 Deg

between an electromagnet mounted on the wall behind the door and a keeper fixed to the back of the door. When the electrical supply to the electromagnet is interrupted, the electromagnet is de-energised and the door automatically closes.

Aspirating Smoke Detectors VESDA

VESDA LaserFOCUS

Designed to protect spaces of less than 250 m², the LaserFOCUS VLF-250 is the cost-effective solution for areas such as Local Telecommunication Exchanges, Air Handling Units, Smaller Server Rooms, Control Rooms / Switch Rooms, Railway Signal Hubs, Storage Facilities, Hazardous Areas (Class 1 Div 2).

The LaserFOCUS VLF-500 is designed to protect areas less than 500m². The LaserFOCUS incorporates first-in-industry Ultrasonic Airflow Sensing to provide flow measurement that is immune to temperature and pressure changes. It's out-of-the-box design makes installation and commissioning quick and easy and the pre-

engineered pipe network designs supplied with the product make system design simple.



Specifications

Operating Voltage	18 to 30Vdc
Operating Current	220mA
Alarm Current	295mA
Operating Temperature	0°C to +40°C
Relative Humidity	5 to 95% (non-cond.)
Ingress Protection	IP30
Dimensions (HWD)	185x255x90mm
Weight	1.9 kg

Part Numbers

VIC-010	VESDANet for VLF-500
VIC-020	Relay Card for VLF-500
VLF-250-02	VLF-250 Relays only
VLF-500-02	VLF-500 Detector

VESDA LaserCOMPACT



VLC-800MX

The LaserCOMPACT detector has been specifically designed to provide all the benefits of aspirating smoke detection, including very early warning, in single small areas and where space is at a premium. This has been achieved through the combination of approved LaserPLUS detection technology, dual stage filtration technology and a modified aspirator design incorporated in a smaller enclosure with simplified display. LaserCOMPACT is available in three versions of interface: relays only (RO), relays and VESDANet™, VIGILANT/SIMPLEX MX.

Features

- Reduced size
- Absolute smoke detection
- Wide sensitivity range
- Single pipe inlet
- Simple display
- Referencing
- VESDANet communication (VN)
- Dual stage dust filter
- Three alarm levels
- Configurable relays
- Air flow monitoring
- Optional remote display and relay capability
- AutoLearn™

Specifications

Operating Voltage	18 to 30Vdc
Operating Current	225mA
Alarm Current	245mA
Operating Temperature	
Sensor Ambient	-10°C to +39°C
Sampled Air	-20°C to +60°C
Relative Humidity	10 to 95% (non-cond.)
Ingress Protection	IP30
Alarm Sensitivity	0.05 to 12%obs/m
Coverage Area	500 m ²
Dimensions (HWD)	225x225x85mm
Weight	1.9 kg

Part Numbers

VLC-505	VESDANet Version (VN)
VLC-500 (RO)	Relays Only Version
VLC-500D	Duct detector
VLC-505D	Duct detector
VESDANet	
VLC-505ETN	VN - Equivalent-to-New
VLC-800MX	VIGILANT MX
VSP-510	Termination Bd (RO)
VSP-515	Termination Bd (VN)

LaserPLUS Standard Modular Range - LaserPLUS Detectors

The detector assembly contains the laser detection chamber, high efficiency aspirator, monitored filter cartridge, control electronics, and relay interface. The detector assembly can be used as a "distributed" system, with the display, programmer and VESDANet

socket modules mounted in a remote location. Alternatively, the detector assembly can be configured as a "self-contained" system by replacing the detector's blank panels with the display and/or programming modules.

Features

- Wide sensitivity range
- Laser-based light source
- 4 Configurable alarm levels
- Purpose built Aspirator
- 4 In-line Inlet pipes
- Flow sensor for each inlet pipe
- Wide range DC power

- Low-cost maintenance
- Dual stage filter
- Easy access to filter cartridge
- 7 Software configurable relays
- Recessed mounting
- Multiple exhausts

Specifications

Operating Voltage	18 to 30Vdc
Operating Current ¹	240mA
Alarm Current ²	290mA
Operating Temp	0°C to +39°C
Relative Humidity	0 to 95% (non-cond.)
Dimensions (HWD)	225x350x125mm
Weight ³	4 kg

1. No display or programmer
2. 24Vdc 3000RPM
3. With display & programmer



VLP-012 LaserPLUS Detector, programmer and display (VLP-001 LaserPLUS with programmer)



VLP-002 LaserPLUS Detector and display

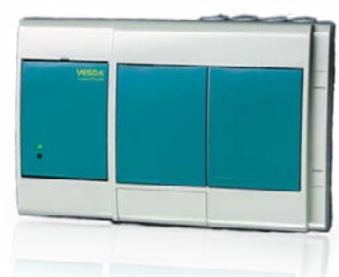

VLP-400 LaserPLUS Detector with fire OK LED

VESDA-E VEA



VEA-040-A10 VESDA-VEA with 3.5" LCD colour touch screen

VESDA-E VEA introduces a new approach for addressable smoke detection. VEA provides pinpoint addressability by using a network of microbore tubes connected to sample points located in the protected area. VEA actively draws air through sample points and analyses for presence of smoke particles in a centrally located smoke sensor module. VEA provides assured detection through active sampling and end to end system integrity monitoring. VEA also provides flexible and fast installation utilizing easy to install flexible microbore tubes and push-fit connectors, which reduce installation time and cost.

VEA detector supports 40 sampling points, which are expandable up to 120 using Expansion StaX, all managed from a central location. Its fully supervised microbore tubes and sampling points ensure total system availability. Centralised Test and maintenance in readily accessible location reduces service time by up to 90% allowing servicing of up to 500 addresses a day lowering total cost of ownership. VEA remote maintenance is ideally suited in applications where interruption free business operation and



VEA-A40-40-STX VESDA-VEA StaX

restricted access are of paramount importance. With best in class connectivity including WAN and Wireless iVESDA application provides real time and remote access for efficient and effective response.

VESDA-E VEA delivers better value where...

- Spot detectors are difficult to reach
- Access to the protected area is restricted
- Disruption of occupants is undesirable
- Installation and maintenance costs are high
- Electrical codes are stringent and conduits are mandatory
- Nuisance alarms are extremely costly
- There is high density of spot detectors

Part Numbers

VEA-040-A00	VEA-40 with LEDs
VEA-040-A10	VEA-40 with 3.5" Display
VEA-020-STX	VEA-20 Expansion StaX
VEA-040-STX	VEA-40 Expansion StaX
VSP-980-W	VEA 6 mm Std Samp.Point
VSP-981-W	VEA 4 mm Std Samp.Point
VSP-982-W	VEA 6 mm Surf.Mnt.Samp.Pt.
VSP-983-W	VEA 4 mm Surf.Mnt.Samp.Pt.



VEA-366-A00 VESDA-VEA with LEDs

Specifications

Operating Voltage	18 to 30Vdc (24V nom.)
Operating Current ¹	20mA
Peak Current	3.5A (scan mode)
Relay Outputs	7
Operating Temp.	0°C to +39°C
Sampled Air Temp.	0°C to +50°C
Relative Humidity	10 to 95% (non-cond.)
IP Rating	IP40
Area Coverage ³	up to 3,345sqm
Sensitivity	0.02% to 16% obs/m
Linear Tube Length	40 x 100m
Dimensions (HWD)	336x352x136mm
Weight ²	10 kg
Relays	7 (exp. to 127) 2A@30Vdc
Interface	USB, Ethernet, WiFi

1. Average current @ 24Vdc
2. With 3.5" LCD, 4 pipe
3. Across up to 40 sampling holes, 40 to 120 microbore tubes

VESDA-E VEP

The VESDA-E VEP series of smoke detectors bring the latest and most advanced detection technology to provide very early warning and the best nuisance alarm rejection to a wide range of applications. Built on the Flair detection technology and years of application experience, VEP detectors achieve consistent performance over their lifetime via absolute calibration. In addition, the VEP delivers a range of revolutionary features that provide user value.

The VESDA-E VEP series of aspirating smoke detectors extend the reach of the VESDA-E platform to a wide range of applications. VEP sensitivity range is from 0.005-20%/m and provides up to 40 Class A holes. VEP is equipped with a powerful aspirator that provides a total of 130m in the one pipe model and 560m in the four pipe model. VEP also provides StaX and Analytics support together with Ethernet, WiFi, USB and VESDAnet capabilities..

Features

- One and four pipe models
- Flair detection technology
- Multi-stage filtration & optical protection with clean air barrier
- Four alarm levels
- Intuitive LCD icon display
- 7 Relays; 2A @ 30Vdc resistive
- Purpose built Aspirator
- Flow fault thresholds per port
- Smart on-board filter
- Extensive event log (20,000 events)
- Backward compatible with VLP & VESDAnet

Part Numbers

VEP-A00-1P	VEP with LEDs, 1 pipe
VEP-A00-P	VEP with LEDs, 4 pipe
VEP-A10-P	VEP with 3.5"LCD, 4 pipe

Specifications

Operating Voltage	18 to 30Vdc (24V nom.)
Operating Current ¹	290mA to 415mA
Alarm Current ¹	325mA to 485mA
Relay Outputs	7
Operating Temp.	0°C to +39°C
Sampled Air Temp.	-20°C to +60°C
Sensitivity	0.005% to 20% obs/m
Relative Humidity	10 to 95% (non-cond.)
IP Rating	IP40
Area Coverage ³	1,000sqm to 2,000sqm
Dimensions (HWD)	225x350x135mm
Weight ²	4 kg

1. Depending on Aspirator setting
2. With 3.5" LCD, 4 pipe
3. One pipe - 1,000sqm, Four pipe- 2,000sqm



VEP-A10-P VESDA-VEP with 3.5" display, 4 pipe



VEP-A00-1P VESDA-VEP with LEDs, 1 pipe
VEP-A00-P VESDA-VEP with LEDs, 4 pipe

VESDA-E VEU

The VEU series of aspirating smoke detectors are the premium detector of the VESDA-E range. An Ultra-wide sensitivity range; 15 times greater than VESDA VLP, and provision for more sampling holes provide an increased coverage in high airflow applications by at least 40%. Considerably longer linear pipe runs and extended branched pipe network configurations cater perfectly to applications with higher ceilings providing an increased coverage by up to 80% whilst allowing convenient detector mounting for ease of service and maintenance. A range of revolutionary new features provide unsurpassed detection performance, flexibility, field programmability, connectivity and reduced total cost of ownership.

Flair is the revolutionary new detection chamber that forms the core of VESDA-E VEP, providing better detection, fewer nuisance alarms, higher stability, increased longevity and particle characterisation. Direct imaging of the sampled particles using a CMOS imager combined with multiple photo-diodes allow vastly more data that can be used to derive actionable information about the observed particles using analytics.

Features

- One, two, three and four pipe models
- Flair detection technology
- Multi-stage filtration & optical protection with clean air barrier
- Four alarm levels
- Intuitive LCD icon display
- 7 Relays; 2A @ 30Vdc resistive
- Purpose built Aspirator
- Flow fault thresholds per port
- Smart on-board filter
- Extensive event log (20,000 events)
- Backward compatible with VLP & VESDAnet

Specifications

Operating Voltage	18 to 30Vdc (24V nom.)
Operating Current ¹	290mA to 415mA
Alarm Current ¹	325mA to 485mA
Relay Outputs	7
Operating Temp.	0°C to +39°C
Sampled Air Temp.	-20°C to +60°C
Sensitivity	0.005% to 20% obs/m
Relative Humidity	10 to 95% (non-cond.)
IP Rating	IP40
Area Coverage ³	up to 6,500sqm
Dimensions (HWD)	225x350x135mm
Weight ²	4 kg

1. Depending on Aspirator setting
2. With 3.5" LCD, 4 pipe
3. Total pipe length with branches - 800m



VEU-A10-P VESDA-VEU with 3.5" display



VEU-A00 VESDA-VEU with LEDs,

LaserPLUS Scanners – 7 & 12 Relay Output Variants

VESDA LaserPLUS is also available in a Scanner configuration, which allows the system to distinguish and identify the pipe carrying smoke, while sampling multiple sectors. The VESDA LaserPLUS will continue to sample from all sectors to monitor the fire growth and maintain full protection.

Features

- Individual pipe annunciation
- Adaptive scan threshold
- Wide sensitivity range (0.005 to 20% obs/m)
- Laser based light source
- Configurable alarm levels

- Purpose built Aspirator
- 4 In-Line inlet pipes
- Flow sensor for each pipe inlet
- Low-cost maintenance
- Dual stage filter
- Easy access to filter cartridge
- Recessed mounting

Specifications

Operating Voltage	18 to 30Vdc
Operating Current ¹	240mA
Alarm Current ²	300mA
Relay Outputs	7 or 12
Operating Temp	0°C to +39°C
Relative Humidity	10 to 95% (non-cond.)
Dimensions (HWD)	225x350x125mm
Weight ³	4 kg**

1. No display or programmer
2. 24Vdc 3000 RPM
3. With display & programmer



VLS-214 FD7 Scanner, programmer and display with 7 relays



VLS-204 FD7 Scanner and display with 7 relays
VLS-304 FD12 Scanner and display with 12 relays



VLS-600 FD7 Scanner with Fire OK LED
VLS-700 FD12 Scanner with Fire OK LED

Optional Remote Displays

A display module monitors the VESDA LaserPLUS detector. It reports a visual representation of smoke levels, and all alarm and fault conditions. The internal sounder warns personnel in the local area that an alarm threshold has been reached, or a fault has occurred. It has a 20 segment vertical bar graph, a 2-digit numerical display, an audible sounder and clear alarm and fault indicators. It also has 4 push buttons to control the detector and the mode of the display. Displays can be located at a convenient location – either within the detector module, or remotely on the VESDAnet. For monitoring convenience, multiple displays can be associated with a single detector.

Features

- Four alarm levels (Alert/Action, Fire 1, Fire 2)
- 20 segment vertical bar graph
- Alarm threshold indicat. (Alert, Action, Fire 1)
- Audio and visual indication
- Alarm indicators
- Informative fault indicators
- Multi-mode numeric display (defaults to smoke obscuration)
- Acknowledged push-button presses
- Multiple language supported
- Addressable to any detector

Specifications

Operating Voltage ¹	18 to 30Vdc
Module Only	
Operating Current	60mA
Alarm Current	80mA @ 24Vdc
Dimensions (HWD)	130x105x30 mm
In Remote Mounting Box (as shown below)	
Operating Current	90mA
Alarm Current	110mA @ 24Vdc
Dimensions (HWD)	150x140x85 mm
Operating Temp	0 to 39°C
Relative Humidity	10 to 95% (non-cond.)

1. When used in detector unit, remote unit or 19" rack



Scanner Displays

- VRT-400** Remote scan display including 7 relays
VRT-700 Remote scanner display – no relays
VRT-800 Remote scanner display with 12 relays



VRT-100 Remote programmer

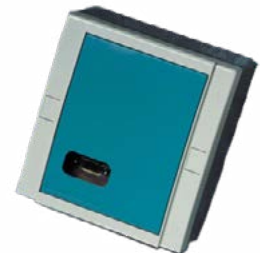

VRT-300 Remote VESDAnet socket

LaserPLUS Displays

- VRT-200** Remote display including 7 relays
VRT-600 Remote detector display – no relays
VRT-J00 Compact Display c/w 7 relays
VRT-K00 Compact Display no relays

LaserINDUSTRIAL Displays

- VRT-Q00** Remote display including 7 relays
VRT-T00 Remote detector display – no relays

LaserPLUS Standard 19 Inch Sub-Rack Remote Display Assemblies



The 19" sub-rack is available as a mounting option, with 4 mounting slots for display or programming modules.

Technical Specification
Dimensions: 128 x 482 x 120 mm (HWD)

Module Numbers

VSR-0	Blank Sub-unit
VSR-1	Programmer sub-unit
VSR-2	LaserPLUS display sub-unit +7 relays
VSR-3	VESDANet Socket
VSR-4	SCANNER display sub-unit + 7 relays
VSR-5	Blank sub-unit with 7 relays
VSR-6	PLUS display with RTC , 0 relays
VSR-7	SCANNER display + RTC, no relays
VSR-8	SCANNER display + RTC+12 relays
VSR-9	DRP + RTC +12 relays

Part Number Examples

VSR-0002	19" Sub-rack with 3 blanks, 1 LaserPLUS display
VSR-0021	19" Sub-rack, 2 blanks, 1 LaserPLUS display, 1 programmer
VSR-004A	19" Sub-rack, 2 blanks, 1 SCANNER display, 1 Programmer
VSR-300J	19" Sub-rack, 1 VESDANet socket, 2 blanks, 1 COMPACT display
VSR-E	Blank SCANNER sub-unit + 7 relays
VSR-J	COMPACT display sub-unit + 7 relays
VSR-K	COMPACT display + RTC-no relays
VSR-S	System Relay Module
VSR-V	LaserFOCUS Display RTC7
VSR-W	LaserFOCUS Display RTC0
VSR-Q	LaserINDUSTRIAL Display + 7 Relays
VSR-CUSTOM	Custom sub-rack housing incl. cost of custom building 4 VSU sub-rack units.

RTC = Remote Termination Card; DRP = Display Relay Processor

Ordering Custom Built Remote Display Sub-racks

Sub-rack configurations other than those available as standard can be supplied as custom built units. The sub-rack and cost of assembly are included in the VSR-CUSTOM. The configuration of the custom built unit must be specified at time of ordering (eg. 2 x VSU-0 and 2 x VSU-2 configured as VSR-0022) Note: The order of the numbers (eg. 0022) indicates the order in which the sub-units will be mounted in the sub-rack housing when looking from the front of the unit - from left to right

LaserPLUS Ancillaries



A variety of other ancillaries are available. Johnson Controls - Fire Detection also stocks pipe and sampling points.

Part Numbers

VHH-100	Hand held programmer and leads
E700-SPLR	Sampling point label
E700-SPDCL	Aspirating pipe label
VSP-511	DB15M - DB15F VESDANet RS485
VSW-004	VConfig Basic software
VSW-005	VConfig Pro software
VSW-002	Aspire Windows software
VESDA 24Vdc,	2A Power supply and charger

VHX-0200 PC-Link High Level Interface



The latest version of the VESDA High Level Interface supports the new Interrogation and Notification functionality of VSM4. Available for both new and existing sites, it is now possible for the HLI to dial out to a PC. The "dial out" option is user configurable allowing site specific configuration to ensure the most important warnings on VESDANet are reported to the right people. The latest VESDA PC Link HLI interfaces between

the VESDA and the PC. Each PC-Link HLI includes an RS-232 cable (from HLI to PC) and an RS-485 cable (from HLI to VESDANet Socket).

Part Numbers

VHX-0200	PC link HLI plus leads (MK2)
VHX-0310	HLI - Open Protocol
VHX-0400	Simplex HLI
VSP-509	DB9M - DB9F Prog. RS232 2m
VSP-511	DB15M - DB15F VESDANet RS485

VESDA Spares

The most commonly used VESDA spares are available ex-stock from Johnson Controls - Fire Detection. Other spares can be supplied as required.

Part Numbers

FIL-FOAM	FILASSY Filter elements	VSP-004	Scanner display (spare)	VSP-018	VLP/VLS Filter Switch Assy
E700-FMK-2	Filter for VESDA Mk2	VSP-005	Filter cartridge (spare)	VSP-019	Filter cover door (spare)
VLC-500ETN	Compact RO (Equiv-To-New)	VSP-006	Spare detector chassis & manifold	VSP-025	VSP-005 Filter Assy - pack of 20
VLC505-ETN	Compact RO (Equiv-To-New)	VSP-006ETN	Plus Chassis (Equiv-To-New)	VSP-501	VLC Aspirator fan
VLC-505ETN	Compact VN (Equiv-To-New)	VSP-008	Spare remote term. card 7 relays	VSP-715	VLF-500 Aspirator fan
VLF-250-02ETN	Focus 250-02 (Equiv-To-New)	VSP-009	Scanner chassis & manifold (spare)	VSP-722	VLF-250 Aspirator fan
VLP-000ETN	Plus 3 blanks (Equiv-To-New)	VSP-009ETN	Scanner Chassis (Equiv -To-New)	VSP-850-G	Inline Filter (repl. E700-FILASSY)
VSP-001	Programmer (spare)	VSP-014	Spare Head term. card 7 relays	VSP-855-20	Inline Filter Elements - pk of 20
VSP-002	Display (spare)	VSP-015	VLP/VLS Aspirator fan		



E700-FMK-2 Filter for VESDA Mk2 System

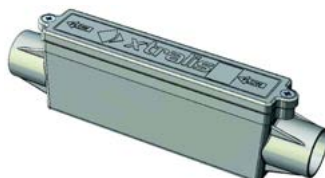

VSP-850-G Inline Filter for any VESDA System. Replacement for E700-FILASSY



VSP-005 Filter Cartridge (suits VLF, VLC, VLP, VLS)

VESDA VLI by Xtralis™

The VESDA VLI is an industry first early warning aspirating smoke detection (ASD) system, designed to protect industrial applications and harsh environments of up to 2000m². With up to 4 inlet pipes and a total pipe length of up to 360m, the IP54 rated VLI detector combines a fail-safe Intelligent Filter (patent pending) with an advanced clean-air barrier for optics protection allowing the use of absolute detection and a long detection chamber life without the need for recalibration. The Intelligent Filter effectively reduces the level of pollution in the air sample before it enters the detection chamber, which dramatically extends the operational life of the detector in harsh and polluted environments. It is fully monitored, therefore providing consistent sensitivity over the entire operational life of the detector.



Specifications

Operating Voltage	18 to 30Vdc
Operating Current	415mA
Alarm Current	440mA
Relay Outputs	5, rated 2A @ 30Vdc
Operating Temp	0°C to +39°C
Relative Humidity	10 to 95% (non-cond.)
Ingress Protection	IP54
Dimensions (HWD)	317x427x180mm
Weight	6 kg
ActivFire Listed	afp-2765

Part Numbers

VLI-880	VESDA VLI
VLI-885	VLI with VESDANet
VRT-Q00	Remote Disp. 7 Relays
VRT-T00	Remote Disp. No Relays
Spares	
VSP-030	VLI Intelligent Filter
VSP-031	VLI-Sec. Foam Filter
VSP-032	VLI Aspirator
VSP-033	VLI Chamber Assembly
VSP-034	VLI-VESDANet Board

VESDA ECO™ Gas Detection



VESDA ECO installed on sampling pipe



VESDA ECO component parts - (L-R) Housing, Sensor Cartridge, Detector

Gas Range and Specifications

VESDA ECO can provide detection of the following gases:-

- Carbon Monoxide (CO) 0-500ppm
- Oxygen (O₂) 0-25% V
- Hydrogen Sulphide (H₂S) 0-100ppm
- Nitrogen Dioxide (NO₂) 0-10ppm
- Propane (C₃H₈) 0-100% LEL
- Ammonia (NH₃) 0-100ppm
- Hydrogen (H₂) 0-100% LEL
- Sulphur Dioxide (SO₂) 0-100% LEL
- Methane (CH₄) 0-100% LEL

Specifications

Operating Voltage	18 to 30Vdc
Operating Current	135mA
Operating Temperature	-20°C to +55°C
Relative Humidity	10 to 90% (non-cond.)
Sampling Pipes	25mm Dia,
Outputs	RS485 MODBUS RTU 4 Relays 1A/30Vdc One 4-20mA
On-Board Memory	Mini SD card 2GB
Ingress Protection	IP65
Dimensions (HWD)	125x34x110mm
Weight	250g
Approvals (pending)	ETL listed to UL 61010-1 ETL listed to CAN/CSA C22.2 No. 61010-1 EN 61010-1

Part Numbers

ECO-D-B-AA	VESDA ECO detector with single gas sensor cartridge for gas AA
ECO-SC-AA	Single gas sensor cartridge

The release of toxic gases, oxygen deficiency, or the presence of combustible gases and vapours can present an invisible yet potentially fatal hazard. When detected at an early stage, countermeasures can be initiated to protect personnel and property. In many facilities, unseen dangers exist from gases and other hazardous substances that can cause enormous damage and loss of life. Combined with the VESDA aspirating smoke detection system, VESDA ECO can provide cost-effective gas detection and environmental monitoring in numerous applications and environments.

ICAM™ IAS Air Sampling Smoke Detection



The ICAM IAS Air-Sampling Smoke Detection system provides a flexible detection solution to meet the needs of numerous applications. The IAS systems actively draws air from the protected area through sampling holes in a pipe network. Sampled air is filtered and then analysed by two MX detectors. The IAS system is available as a twin inlet pipe configuration (IAS-2), and can be fitted with two detectors per system. Flow failure is reported as a device fault via an MX MIM800 module.

Features

Ideal for areas where access is restricted, harsh environments and areas where a point detector would be damaged.

- Powerful fan
- Two x 100m pipe runs
- Pipes individually monitored for air flow with LED bar graph
- Fault monitored via the MX Loop
- IP65 enclosure
- Field serviceable air filters
- Uses standard 25mm Vesda pipe & fittings

Applications:

Ideal for areas where access is restricted, harsh environments and areas where a point detector would be damaged. Such as:-

- Lift Shafts
- Floor / Ceiling Voids
- Cabinet Protection
- Conveyor Tunnels
- Hose Down Areas
- Stables
- Prison Cells
- Areas with Low Ceilings

Specifications

Operating Voltage	18 to 30Vdc
Operating Current	300mA
Alarm Current	245mA
Operating Temp.	-10°C to +55°C
Relative Humidity	10 to 90% (non-cond.)
Sampling Pipes	25mm Dia, 100m / inlet
Dimensions (HWD)	184x259x166mm
Weight	2.77 kg
ActivFire Listed	afp-2434

Part Numbers

516.016.301	ICAM Air Sampling Detector
516.016.303	ICAM Course Filter
516.016.304	ICAM IAS801 1-Pipe Air Sampling Detector
516.016.305	ICAM IAS802 2-Pipe Air Sampling Detector

Note: Detectors must be ordered separately.

VESDA Pipe and Fittings



E700-CSC Capillary Sampling Connector



E700-CT Capillary Sampling Tube 8mm OD



E700-EC End Cap - Not Drilled



E700-PC Pipe Clip - Single Point Fix

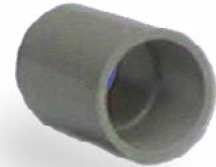

E700-PJ Pipe Junction Fitting



E700-SP Sampling Point - Mini



E700-LB Long Radius Bend 150mm



E700-TA Trunk Adaptor



E700-SPLR Sampling Point Label (1 label)



E700-SB Small Radius Bend 90mm



E700-T Solid Tee



E700-SPDCL Sampling Point Decal (200 per roll)



E700-P VESDA Pipe 4 metre x 10 Lengths (bell end) - 100% UPVC



E700-J 2 Branch Adaptor



E700-HASP Heat Activated Sampling Point



E700 HASP Kit Heat Activated Sampling Point requires E700-TA, E700-SRB, E700-CSC and E700-HASP.



E700-SRB Standard Base for HASP with CSC

Flame and Special Hazard Detectors

FV400 FLAMEVision Triple IR Solar Blind Flame Detector (Flameproof)



The FLAMEVision FV400 detectors are intended for applications demanding a high level of protection and where a rapid response to fire is important. Typical applications are:

- Refineries
- Drilling and Production Plants
- Fuel loading facilities
- Compressor Stations
- Chemical production
- LNG/LPG processing & storage
- Gas Turbines
- Waste management/transfer
- Aircraft Hangars
- Sports Stadia
- Tank Farms
- Printing Industry
- Warehousing
- Munitions Storage

FLAMEVision FV400 uses Triple IR Solar Blind technology for flame detection. This provides a reliable and cost effective solution in standard flame detection applications especially where there is a single hazard in the field of view. The FV400 FLAMEVision Triple IR Solar Blind sensing technology and flame detection algorithms provide high performance sensing capabilities for hydrocarbon fires. This includes the ability to reliably sense flames through high densities of solvent vapours and black smoke, increasing the probability of early detection with consistent high sensitivity to flame throughout the whole field of view. They also ensure consistent detection of many different types of hydrocarbon fuels from alcohol to aviation fuel. Multiple interfaces are provided.

Specifications

Supply voltage:	15 to 30 Vdc
Current (@24Vdc):	12 mA quiescent 22 mA Alarm (interface dependant)
Window Heater:	245mA @ 24 V
Dimensions	156x153x92mm (HWD)
Weight	4kg
Gland Entry	2x M20
ActivFire Listed	afp-2969
FPANZ Listed	VF/364 (FV411f) VF/365 (FV412f) VF/366 (FV413f)
IECEX	ITS 12.0035X (Ex d)
ATEX	ITS12ATEX17586X (Ex d)
FV421i (Ex ia)	
IECEX	IECEX BAS 14.0113X
ATEX	Baseefa 14ATEX0245X

External supply required only for heater or MODBUS options

Benefits

- Heated optics ensures no sensitivity-reducing moisture build-up on the lens
- Range of integral field interface options including a 4–20mA output, configurable as Sink or Source
- Automatic monitoring of detector functionality including signal transmission through the window. In addition, in most configurations the WT300 test tool can be used to simplify servicing
- Over 50m detection range with unrestricted 90° field of view
- Internal event log to help operators review post-incident data

Part Numbers

516.300.411	FV411f Flameproof, no camera
517.300.001	MB300 Mounting Bracket
517.300.002	WH300 S/S Weather Hood
517.300.003	ADP300 Adaptor, FV411 to S200 Mnt
517.300.021	WT300 Walk Test Tool
517.300.024	CTI400 Off-line Configuration Tool
517.300.006	MK300 Field Spares Kit
516.041.003	S271f+ MX Flameproof
516.041.004	S271i+ MX Intrinsically Safe
516.300.421	FV421i Ex ia IR Flame Det.

Features

- Triple waveband infrared solar-blind flame detection for optimum false alarm immunity
- Unrivalled black body rejection
- Automatic Optical Integrity Monitoring
- 4 Range settings: <6m, 15m, 33m & 65m (0.1m² n-heptane fire on-axis)
- Configurable via DIP switch or PC software
- Able to see flames through smoke and through high densities of solvent vapours, thus increasing the probability of early detection of hydrocarbon fires
- Insensitive to artificial light sources
- Consistent high-sensitivity flame detection throughout a 90° field of view
- Consistent detection of different types of hydrocarbon fuels
- Integral flame simulation for verification of detection path enabling either easy walk-testing of the installation or testing by remote control to ensure continued reliability of the detector operation

Intrinsically Safe - MX Analogue Addressable Detectors

Features

- Suitable for worst case (EEx ia IIC T5)
- VIGILANT High Performance Optical (HPO) smoke detector
- Compatible with S271i+ plus flame detector
- Compatible range of I.S. callpoints
- IECEx Certification for most devices

The System Designer must have completed an appropriate recognised course in Intrinsic Safety and be familiar with AS/ NZS 2381.1: 2005 and associated standards, test organizations, and the requirements of state and local authorities. Requirements can differ from region to region. The probability of a flammable mixture being

present is defined by a Zone Number. Flammable gases are classified in Groups and their minimum spontaneous ignition temperature is categorised by Class. Johnson Controls supplied equipment marked EEx ia IIC T5 would be suitable for use in worst case conditions, eg. Zone 0 (ia), Hydrogen (IIC), T5 (100°C). The Fire Alarm Equipment and Safety Barriers should be placed as near as possible to the containment wall of the Hazardous Area. This minimises the cable lengths between the barrier and the Hazardous Area and thus the capacity to store energy. In order that an Installation will comply with the certification designated for each system it is essential that the certified devices are connected

with cables of the specified limits. These limits have been certified for specific classifications of hazard in order that energy storage is limited. The number of devices connected to the barrier and located in the Hazardous Area must always be limited to not more than the listed maximum. When a mixture of devices is connected to any one zone the numbers must be reduced in proportion to the ratio of the load presented to the barrier.

Note: Unless otherwise stated, these Intrinsically Safe devices are not ActivFire Listed. For non-addressable Intrinsically Safe detectors, see page 104.

801PHEX Smoke and Heat Detector



The 801PHEX Intrinsically Safe Optical Smoke & Heat Detector plugs into a 5BEx base. The detector is designed to transmit to a remote MX fire controller, digital signals which represent the status of the optical smoke and heat elements of the detector. Software within the controller interprets the returned optical and heat values to raise an alarm or other appropriate response according to the type of programmed configuration. The mode of detector may be:

- Optical smoke only detector (High/ Normal/Low)
- HPO smoke detector (sensitivity High, Normal or Low)
- Heat only rate-of-rise (A1R) detector (no sensitivity selection)
- Heat fixed temperature 60°C (A2S) (no sensitivity selection)
- Optical (sensitivity High, Normal or Low) combined with heat fixed temperature 60°C (A2S)
- HPO (sensitivity High, Normal or Low) combined with heat fixed temperature 60°C (A2S)

These detectors are designed to comply with EN 50 014 and EN 50 020 for intrinsically safe apparatus. They are certified:

- ATEX Code: Ex II 1G
- IECEx Code: Ex ia IIC T5

Specifications

Operating Voltage	18 to 24Vdc
Quiescent Current	400µA (max.)
Alarm Current	3.5mA (max.)
Operating Temperature	-25°C to +70°C
Relative Humidity	10% to 95% (non-cond.)
FPANZ Listed	VF/351
IECEx Certificate	IECEx BAS 07.0063X

Part Numbers

516.800.530	801PHEX
-------------	---------

801CHEX Carbon Monoxide and Heat Detector



The 801CHEX Intrinsically Safe Carbon Monoxide plus Heat Detector forms part of the 800Ex Intrinsically Safe Series of MX Addressable Fire Detectors. The detector plugs into a 5BEx base. The detector is designed to transmit to a remote MX fire controller, digital signals which represent the status of the carbon monoxide and heat elements of the detector. Software within the controller is used to interpret the returned Carbon Monoxide and heat values to raise an alarm or other appropriate response according to the programmed configuration. The mode of detector may be:

- Heat only detector (A1R or A2S) (sensitivity: High, Normal or Low)
- Compensated Carbon Monoxide detector (sensitivity: High, Normal or Low)
- Compensated Carbon Monoxide detector (sensitivity: High or Normal) combined with heat (A1R)

These detectors are designed to comply with EN 50 014 and EN 50 020 for intrinsically safe apparatus. They are certified:

- ATEX Code: Ex II 1G
- IECEx Code: Ex ia IIC T5

Specifications

Operating Voltage	18 to 24Vdc
Quiescent Current	400µA (max.)
Alarm Current	3.5mA (max.)
Operating Temperature	0°C to +50°C
Relative Humidity	15% to 90% (non-cond.)
FPANZ Listed	VF/352
IECEx Certificate	IECEx BAS 07.0063X

Part Numbers

516.800.531	801CHEX
-------------	---------

801HEX Heat Detector



The 801HEX Intrinsically Safe Heat Detector forms part of the 800Ex Intrinsically Safe Series of MX Addressable Fire Detectors. The detector plugs into a 5BEx base. The detector is designed to transmit to a remote MX fire controller, digital signals which represent the status of the heat element of the detector. Software within the controller is used to interpret the returned heat values to raise an alarm or other appropriate response according to the programmed configuration.

The mode of detector may be:

- EN54-5 A1R, rate-of-rise normal ambient
- EN54-5 A2S, fixed 60°C
- EN54-5 CR, rate-of-rise high ambient

These detectors are designed to comply with EN 50 014 and EN 50 020 for intrinsically safe apparatus. They are certified:

- ATEX Code: Ex II 1G
- IECEx Code: Ex ia IIC T5

Specifications

Operating Voltage	18 to 24Vdc
Quiescent Current	400µA (max.)
Alarm Current	3.5mA (max.)
Operating Temperature	-25°C to +70°C
Relative Humidity	10% to 95% (non-cond.)
FPANZ Listed	VF/216
IECEx Certificate	IECEx BAS 07.0063X

Part Numbers

516.800.532	801HEX
-------------	--------

801FEx Flame Detector



The 801FEx Intrinsically Safe Flame Detector forms part of the 800Ex Intrinsically Safe Series of *MX* Addressable Fire Detectors. The detector plugs into a 5BEx base. The detector is designed to transmit to a remote *MX* fire controller, digital signals which represent the infrared radiation produced by flaming fires involving carbonaceous materials. The 801FEx is a full featured flame detector for indoor applications. It must be connected via an EXI800 interface and galvanic barrier.

These detectors are designed to comply with EN/IEC 60079-0:2006, EN/IEC 60079-11:2007 and EN/IEC 61241-11:2006 for intrinsically safe apparatus. They are certified:

- ATEX Code: Ex II 1 GD
- IECEx Code: Ex ia IIC T4

Specifications

Operating Voltage	18 to 24Vdc
Quiescent Current	350µA (max.)
Alarm Current	3.3mA (max.)
Operating Temperature	-25°C to +70°C
Relative Humidity	10% to 90% (non-cond.)
FPANZ Listed	
ATEX Certificate	Baseefa03ATEX0422X
IECEX Certificate	IECEXBAS07.0075X

Part Numbers

516.800.066	801FEx (Aus)
801FEx	801FEx (NZ)
592.001.012	T110 Test Source
592.001.018	Test Source Adaptor

CP840Ex Manual Call Point



The CP840Ex Intrinsically Safe Waterproof Break Glass Manual Call Point is designed to monitor and signal the condition of the switch contact associated with the call point.

The callpoint is designed to comply with EN 50 014 and EN 50 020 for intrinsically safe apparatus. It is certified:

IECEX Certificate	BAS 07.0063X
ATEX Classification	Ex II 1 G
ATEX Certificate	BAS01ATEX1394X
Cenelec Classification	EEx ia IIC T5

The CP840Ex does not comply with NZS4512.

Specifications

Operating Voltage	18 to 24Vdc
Quiescent Current	300µA (max.)
Alarm Current	5mA (max.)
Operating Temperature	-25°C to +70°C
Relative Humidity	10% to 95% (non-cond.)
Dimensions (HWD)	124 x 124 x 59 mm
Ingress Protection	IP67
ATEX Certificate	BAS01ATEX1394X
IECEX Certificate	BAS 07.0063X

Part Number

514.800.513	CP840Ex
-------------	---------

EXI800 Interface Module and Galvanic Isolator



The EXI800 Interface Module, used with a galvanic isolator, provides a path for an *MX* Panel to transparently communicate to slave devices (800Ex Detectors, IF800Ex Interface Module or CP840Ex Addressable Break Glass Callpoint) connected to the Intrinsically Safe loop. The interface reduces the standard *MX* loop supply voltage and signalling currents to levels that are acceptable for hazardous areas. The EXI800 can detect a short circuit on the left-loop, the right-loop, or the I.S. loop and will isolate the offending loop connections from the other loop connections. The I.S. loop output of the EXI800 interfaces with the Pepperl+Fuchs KFD0-CS-Ex1.54 Galvanic Isolator, supplying loop voltage and signalling currents to the Intrinsically Safe loop.

Specifications

DC Input Voltage	20 to 37.5Vdc
DC Output Voltage	28.0Vdc
AC Input Signalling Voltage	1 to 4Vpp
AC O/P Signalling Voltage	1 to 4Vpp
AC Input Signalling Current	40mA (max.)
AC O/P Signalling Current	40mA (max.)
Operating Temperature	-25°C to +70°C
Relative Humidity	10% to 95% (non-cond.)
Dimensions (HWD)	115 x 103 x 20 mm
Ingress Protection	IP20
FPANZ Listed	VF/658
IECEX Certificate	BAS 08.0079 (Isolator)

Part Numbers

514.001.063	EXI800
517.001.259	I.S. Galvanic Isolator

IF800Ex Interface Module



The Intrinsically Safe IF800Ex Interface Module is designed to monitor fire contacts such as extinguishing system controls, ventilation controls, fire door controls etc. The IF800Ex is contained within a grey compression moulded glass filled polyester box with 3 x 20mm cable gland holes. The electronic components are mounted on a double sided printed circuit board built into a potted module formed from a plastic moulding. Connectivity is via two terminal blocks fitted to the circuit board.

The interface module is designed to comply with EN 50 014 and EN 50 020 for intrinsically safe apparatus. It is certified:

IECEX Certificate	BAS 07.0063X
ATEX Classification	Ex II 1 G
Cenelec Classification	EEx ia IIC T5

Specifications

Operating Voltage	18 to 24Vdc
Quiescent Current	325µA (max.)
Alarm Current	3.5mA (max.)
Type Identification Value	147
Operating Temperature	-25°C to +70°C
Relative Humidity	10% to 95% (non-cond.)
Dimensions (HWD)	120 x 122 x 95 mm
Ingress Protection	IP65
FPANZ Listed	VF/659
IECEX Certificate	BAS 07.0063X

Part Number

514.001.062	IF800Ex
-------------	---------

Intrinsically Safe – Conventional (Non-Addressable) Detectors

Note: Unless otherwise stated, these Intrinsically Safe devices are not ActivFire Listed. For MX Addressable Intrinsically Safe detectors, see page 102

MR601TEx Intrinsically Safe High Performance Optical Smoke Detector



The MR601TEX has been developed to overcome the slower response of the optical detectors to hot burning fires, by increasing the sensitivity of the optical detector when it is associated with a rapid change in temperature. In this way it is intended to become a detector which can cover some of the risks currently covered by ion chamber detectors. Smoke detectors will not detect burning alcohol or other clean-burning liquids which do not generate smoke particles.

Specifications

Operating Voltage	16 to 28Vdc
Operating Current	110 µA (max.)
Alarm Current	30mA @ 16Vdc
Operating Temp	-20°C to +70°C
Relative Humidity	95% (non-cond.)
Dimensions	109 dia x 43 H mm
Weight	128g
ATEX Certificate	BAS01ATEX11134X.
IECEX Certificate	BAS 07.0056X
Part Number	516.054.011.Y

MDU601Ex Enhanced Point Type Carbon Monoxide Fire & Heat Detector



The MDU601EX detector combines the features of both the MU601EX detector and the MD601EX detector to provide a combined CO and Rate of Rise Heat Detector where the sensitivity of the CO detector is enhanced in response to a fast rate of change of temperature.

Specifications

Operating Voltage	16 to 28Vdc
Operating Current	70 µA (max.)
Alarm Current	30mA @ 15Vdc
Operating Temp	-20°C to +70°C
Relative Humidity	90% (non-cond.)
Dimensions	109 dia x 43 H mm
Weight	126g
ATEX Certificate	BAS01ATEX1134X
IECEX Certificate	BAS 07.0056X
Part Number	516.061.001

MD601Ex/MD611Ex Intrinsically Safe Heat Detectors



Where environmental conditions rule out the use of smoke detectors, MD601Ex/MD611Ex heat detectors may provide an acceptable, though less sensitive, alternative. For general use (particularly where the ambient temperature may be low) a 'Rate-of-Rise' (ROR) heat sensor is preferred. These detectors react to abnormally high rates of change of temperature and provide the fastest response over a wide range of ambient temperatures. A fixed temperature limit is incorporated in these detectors. In kitchens and boiler rooms etc, sudden, large changes in temperature are considered 'normal'. Fixed temp. [static] detectors should be used in this case.

Specifications

Operating Voltage	16 to 28Vdc
Operating Current	100µA (max.)
Alarm Current	5 to 80mA
Operating Temp	-20°C to +70°C
Relative Humidity	95% (non-cond.)
Dimensions	109 dia x 43 H mm
Weight	116g
ATEX Certificate	BAS01ATEX1134X
IECEX Certificate	BAS 07.0056X
Part Numbers	
516.052.051	MD601EX ROR Heat Detector
516.052.041	MD611EX Fixed Temp Heat Detector

MCP220Ex Intrinsically Safe Manual Call Point



The MCP220Ex Intrinsically Safe Waterproof Break Glass Manual Call Point is designed to monitor and signal the condition of the switch contact associated with the call point. The callpoint is designed to comply with EN 50 014 and EN 50 020 for intrinsically safe apparatus. It is certified:

IECEX Certificate	IECEX SIR 08.0105X
ATEX Certificate	SIRA 06ATEX2131X
Cenelec Classification	EEx ia IIC T4 Ga

The MCP220Ex does not comply with NZS4512.

Specifications

Operating Voltage	18 to 30Vdc
Alarm Current	500mA (max.)
Operating Temperature	-30°C to +70°C
Relative Humidity	10% to 95% (non-cond.)
Dimensions (HWD)	93x 98 x 63 mm
Weight	270g
Ingress Protection	IP67
ATEX Certificate	SIRA 06ATEX2131X
IECEX Certificate	IECEX SIR 08.0105X
Part Number	
514.001.109	MCP220Ex

601FEx Infrared Flame Detector



The 601FEx point type flame detectors are part of the 600 series of non-addressable detectors. The 601FEx is a full featured flame detector for indoor use. It has a high degree of false alarm immunity. The 601FEx and it is designed for connection to a conventional zone of point type fire detectors that may include any mix of detection technologies. The 601FEx is an intrinsically safe version intended for use in hazardous atmospheres and must be connected via a suitable isolator or shunt diode safety barrier in a certified Intrinsically Safe system.

Specifications

Operating Voltage	16 to 28Vdc
Operating Current	300 µA (max.)
Alarm Current	30mA @ 15Vdc
Operating Temp	-20°C to +70°C
Relative Humidity	90% (non-cond.) ¹
Dimensions	108 dia x 22 H mm
Weight	110g
Range	0.1m ² n-heptane @ 20m 0.4m ² n-heptane @ 50m
Field of View	100°
ATEX Certificate	BASEEFA03ATEX0422X
ATEX Code	Ex II 1 G
Cenelec Code	EEx ia IIC T5
IECEX Certificate	BAS 07.0075X

Part Numbers

516.600.066	601FEx Detector
592.001.012	T110 Test Source
592.001.018	Test Source Adaptor

1. 90% RH continuous; 99% RH (non-cond.) intermittent operation

5BEx Detector Base



The 5BEx detector base is classed as a simple apparatus, the detectors are certified:
ATEX Ex II 1 G, certificate no. BAS10ATEX1134X
IECEX Ex ia IIC T5, certificate no. .BAS 07.0063X.

Specifications

Dimensions 126 dia x 24H mm
Weight 64g

Part Numbers

517.050.023
5BEx Base for
Intrinsically
Safe Detectors

T54B Probe Type Heat Detector



Constructed from stainless steel, the T54B is an extremely rugged heat detector that can be used to detect fires in the harshest of environments. The T54B can be used in environments with ambient temperatures up to 280°C and, being hermetically sealed, is impervious to most

contaminants. The T54B is a simple device and therefore suitable for use in intrinsically safe areas when used with a suitable I.S. barrier. For reliable operation, it is recommended that T54B detectors have set points 20°C or 20% (whichever is higher) above the maximum temperature they will be exposed to in normal operation. Preferred factory preset temperatures range from 60° to 250°C; with normally open contacts. Other temperatures and normally closed contacts are available by request.

Part Numbers

T4E60X	T54B Heat Detector - 60°C
T4E90X	T54B Heat Detector - 90°C
T4E100X	T54B Heat Detector - 100°C
T4E145X	T54B Heat Detector - 145°C

Specifications

Operating Voltage	32VAC to 32Vdc
Switching Current	5 to 200mA
Contact Resistance	<1 ohm
Actuating Temp.(preset)	60 to 240°C
Fixed Temp. Only	Type E
Accuracy	+ or - 5%
Ambient Temp.	-40 to +280°C
Relative Humidity	100% RH
Dimensions Body	16 dia x 80mm
Hex	25.4AF
Thread	M20x1.5 x 20mm
Weight	95g
Ingress Protection	IP67
ActivFire Listed	afp-1612
FPANZ Listed	VF/214

Latching Remote Indicators

The E500 Mk2 range of latching remote indicators provide latching remote indication of an alarm condition on fire detectors such as the T54B Probe Type Detector. Refer to page 47 for further details.. The latching remote indicators are not Intrinsically Safe.

Part Numbers

E561	Fire Alarm in Concealed Space
E573	Fire Alarm in Room
E574	Fire Alarm Above
E575	Fire Alarm in Duct
E566	Fire Alarm in Roof Space

ZAU401 Zone Adaptor Unit

The ZAU401 (Rev 2) can be thought of as a single zone circuit module that can be added to different panels to make them compatible with specific detectors. The AZC characteristics of the ZAU401 make it particularly suitable for Intrinsically Safe applications when used with I.S. barriers. Refer to page 108 for further information.

Part Number

PA0838 ZAU401 Zone Adaptor Unit

Intrinsically Safe Isolators/Barriers

The following section relates to a range of intrinsically safe isolator and barrier equipment for use with Johnson Controls – Fire Detection manufactured fire detection systems. On all issues of intrinsically safe systems design, please refer to all the relevant product manuals for guidance.

KFDO-Ex151

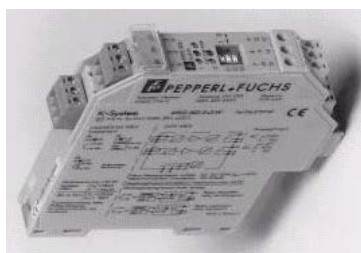

This device's channel (4 terminals per channel) functions like a "DC current isolator". The input and output are galvanically isolated from each other. These units are designed for the connection of fire detectors. Their increased current range and the higher accuracy allow for differentiation between normal operation, fire alarm, lead breakage and short circuit currents in the safe area. They may also be used for controlling I/P converters. A separate power supply with auxiliary power is not required.

Due to the input voltage limiting of 24V, the maximum voltage output is 21V.

Specifications	IECEX Certification	IECEX BAS 05.0004
Part Number	KFDO-Ex151	Single Channel Output EEx ia IIC Device installation permissible in zone 2 Polarity reversal prot. Accuracy 1%

KFDO-Ex251

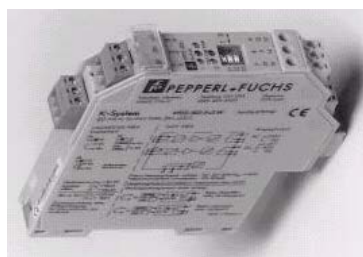

Each channel (4 terminals per channel) functions like a "DC current isolator". Both channels have separate reverse polarity protection. The input and output are galvanically isolated from each other. These units are designed for the connection of fire detectors (smoke and/or heat detectors etc). Their increased current range and the higher accuracy allow for differentiation between normal operation, fire alarm, lead breakage and short circuit currents in the safe area. They may also be used for controlling I/P converters. A separate power supply with auxiliary power is not required. Due to the input

voltage limiting of 24V, the maximum voltage output is 21V. This 2 channel version allows for the connection of 2 independent circuits in a single housing.

Specifications	IECEX Certification	IECEX BAS 05.0004
Part Number	KFDO-Ex251	Dual channel output EEx ia IIC Device installation permissible in zone 2. Polarity reversal prot. Accuracy 1%

KFD2-STC4-Ex1



SMART transmitter power supplies provide a 2- or 3-wire SMART transmitter and transfer the analogue values. Digital signals may be superimposed on the analogue values, which will be transferred bidirectionally. An internal resistor at terminal 9 is available, which may be used to increase the AC impedance for the HART signal. This device replaces the KFDO-EX130 single channel barrier. The 6-terminal KFD2-STC4-Ex1 is typically used on systems where higher numbers of intrinsically safe detectors are required.

Features

- 1-channel
- Device installation permissible in Zone 2
- Input EEx ia IIC; $U_o = 25.4\text{ V}$
- Galvanically isolated output
- 24 Vdc supply voltage
- SMART capable up to 7.5 kHz (-3 dB)
- Input 0/4 mA to 20 mA
- Output 0/4 mA to 20 mA

Specifications	IECEX Certification	IECEX BAS 04.0016
Part Number	KFD2-STC4-Ex1	Single Channel Output EEx ia IIC 24Vdc supply voltage Output max. 1kOhm load

Beam Smoke and Linear Heat Detectors

FW68/105/180



Fire Wire is a heat sensitive cable that provides continuous detection over long distances. Available in a range of actuation temperatures (from 68°C to 180°C), Fire Wire is ideal for heat detection in storage racks, conveyors, cable trays and other situations where it is desirable that detection is always close to potential sources of fire. Fire Wire is a twin conductor cable protected by a rugged outer sheath. The copper-covered steel conductors are separated by temperature sensitive insulation and twisted together. When Fire Wire cable is exposed to sufficient heat, the heat sensitive insulation

melts allowing the two conductors to touch, thus signalling an alarm. When using Fire Wire it is important to ensure that it is not affected by localised hot spots. Before selecting an actuating temperature for a particular area, determine the worst case maximum ambient temperature for that area. As it is a simple device, the FW series can be used in Zone 0 areas when connected to a suitable intrinsically safe barrier. FW68/105/180 is available only in multiples of 100m lengths.

Note that FW68 is suitable for indoor use only. Whilst FW105/180 may be used in external applications, it must be protected from direct sunlight.

Part Numbers

FW68	68°C Sensor Cable
FW105	105°C Sensor Cable
FW180	180°C Sensor Cable
4300	Junction Box

Specifications	Operating Voltage (max)	32VAC or 115Vdc
	Alarm Current (max) ¹	300mA
	Conductor Loop Resist.	100 Ohm/km
	Operating Temp °C	Ambient Alarm
	FW68 ²	-65 to +45 +61 to +70
	FW105 ³	-65 to +70 +97 to +113
	FW180 ³	-65 to +105 +168 to +180
	Relative Humidity	Up to 100% (non-cond)
	Detection Time (approx.)	
	FW68	4 seconds
	FW105	10 seconds
	FW180	20 seconds
	Bend Radius	50mm minimum
	Insulation Material	
	FW68	Polythene
	FW105/180	PVC
	ActivFire Listed ⁴	afp-821 (FW68)

1. Must be externally limited
2. FW68 is suitable for internal use only
3. FW105 & 180 is suitable for use in external applications when shielded from direct sunlight
4. With 4300 Junction Box every 100m

OSID Smoke Detector



Open area Smoke Imaging Detection (OSID) is designed for large, open spaces - airports, train stations, stadiums and shopping centres, etc. applications that pose unique challenges to reliable fire detection. By using UV and IR wavelengths to detect particles, the system is able to distinguish between particle sizes, and provide repeatable absolute smoke obscuration values, while rejecting the presence of dust particles or solid intruding objects. With a range of up to 150m (OSI-10 only) and easy alignment OSID is ideal for use in a wide range of applications.

Specifications

Operating Voltage	20 to 30Vdc
Imager Op. Current	4mA nom. (1 Emitter) 7mA nom. (7 Emitters)
Peak Current	27mA (training mode)
Operating Temp	-10°C to +55°C
Relative Humidity	10 to 95% (non-cond.)
Ingress Protection	IP44 (electronics) IP66 (optics enclosure)
Dimensions (HWD)	130x198x96mm
Weight	585g (Emitter) 610g (Imager)
ActivFire Listed	afp-2539
FPANZ Listed	Various (refer to Xtralis section)

Part Numbers

OSI-10	Imager 7deg (1 SP Emitter max.)
OSI-90	Imager 80deg
OSE-SP	Emitter (std. pwr. Batt.)
OSE-SP-01	Emitter batt. exch. unit
OSE-SPW	Emitter (std.pwr. 24V)
OSE-HPW	Emitter (high pwr 24V)
OSP-002	Laser Alignment Tool
OSE-ACF	Anti-Condensation film for Emitter, Pkt of 10
OSEH-ACF	EH Anti-Condensation film for Emitter, Pkt 10
OSI-LS	Light Shield for OSI-10
OSID-EHE	Emitter Environmental Housing
OSID-EHI	Imager Environmental Housing
OSID-INST	Install Kit incl. Laser & Filter
OSID-WG	Wire Guard
OSD-RBA	Emitter Replacement Battery Pack

Features of OSID

- Maximum detection range up to 150m
- Status LEDs for fire, fault and power
- High nuisance-alarm immunity
- Dust and intrusive solid-object rejection
- Easy alignment with large adjustment and viewing angles
- High tolerance to building flex & vibration
- Simple DIP switch configuration
- Dual wavelength LED-based smoke detection
- Limited maintenance requirements
- Conventional alarm interface for straightforward fire system integration
- Configurable alarm thresholds
- Both wired and battery-powered Emitters available

Benefits of OSID

- Simple and quick installation
- High tolerance to vibrations, building movement and high airflow
- Reliable discrimination between real smoke and other intruding objects such as dust, steam, birds, insects and forklifts
- Requires only 200mm free space
- 3-D coverage

OSID Applications

OSID is ideal for use in a wide range of industries and applications. These include atriums, domes and large rooms in:

- Airports
- Train Stations
- Shopping Centres
- Stadiums
- Educational facilities
- Hotels, convention centres and office buildings/complexes
- Entertainment venues
- Warehouses and production floors

Four OSID Emitters within the field-of-view of a single Imager

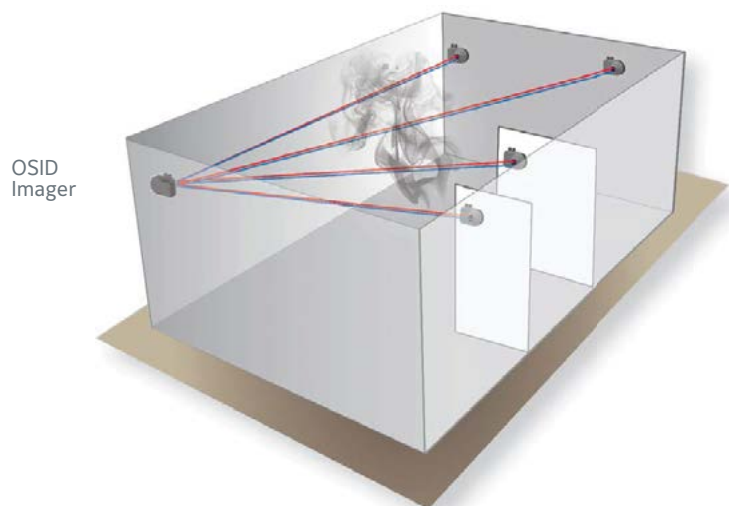

True Spatial Detection

Optical Fibre Temperature Sensing



This new technology uses a laser light source to launch light signals into an optical fibre. As pulses travel down the fibre, energy is lost through scattering. A fraction of the scattered signal is retained within the fibre. A portion of this is directed back along the fibre towards the laser source - this signal is called backscatter. Part of the back scatter signal (Raman Scattering) is used to provide accurate remote temperature measurements at hundreds of points along the fibre.

The system uses standard communications grade optical fibre of the 62.5/125 graded index multimode type. The temperature range is predominantly a function of the coating used to protect the optical fibre as the fibre itself is well behaved over a temperature range from -50°C to approximately 300°C.

Optical fibre itself offers several advantages as a sensing medium. The signals are immune to electromagnetic interference thereby ensuring integrity of readings from electrically noisy areas. As no electrical current is used in the sensing fibre and the fibre is relatively inert and dielectric (non-conducting) medium, it is safe technology to use in hazardous environments.

Features

- Fibre optic sensor loop up to 2km, 4km or 8km
- Continuous temperature profiles of temperature on a PC
- Programmable functions
- Programmable number of fire detection zones
- Multiple and programmable Alarm levels per fire detection zone
- Variable rate of rise function
- Unrivalled response times
- Optional outputs
- Modbus Serial Data
- Direct to PC
- Volt free contacts
- Insensitive to EMI
- Intrinsically safe sensor
- Uses standard communications grade optical fibre
- Choice of cable construction
- Cable construction for extreme environments
- High System Integrity
- Automatic failure mode analysis
- Loop break recovery operation
- Diagnostic capability
- Fire progression monitoring
- No cable maintenance
- Modem for remote communications

Specifications

Supply Voltage	24Vdc (-6/+12Vdc)
Power Consumption	20W max
Supply Current	<1A
Fuse Rating	<2A (anti-surge)
Fibre	62.5/125 graded index multi-mode
Operating Temp	0°C to +40°C
Storage Temp	-40°C to +65°C
Relative Humidity	0 to 95% (non-cond.)
Compliance	
Class 3a Laser	IEC 825 (1990) BS7192(1989) ANSI Z136.2(1988)
EMC	Directive 89/336/EEC
Low Voltage	Directive 72/2/EEC

System Components

- Control Unit - available as:
 - Cabinet, including 32 relays and PSU in 2km, 4km, 8km models
 - 19in Rack Mounting including 32 relays, in 2km, 4km, 8km models
- Sensor Line thermoplastic sensor cable in 1, 2 or 4.4km reel
- Sensor Tube stainless steel sensor cable in 1, 2 or 4.4km reel
- For further information and pricing, contact your local Johnson Controls Fire Detection Representative

Important The Control Unit contains complex high precision components including a single-mode laser which can be seriously damaged or misaligned if subjected to undue mechanical shock or ingress of dust etc.

Functional Block Diagram

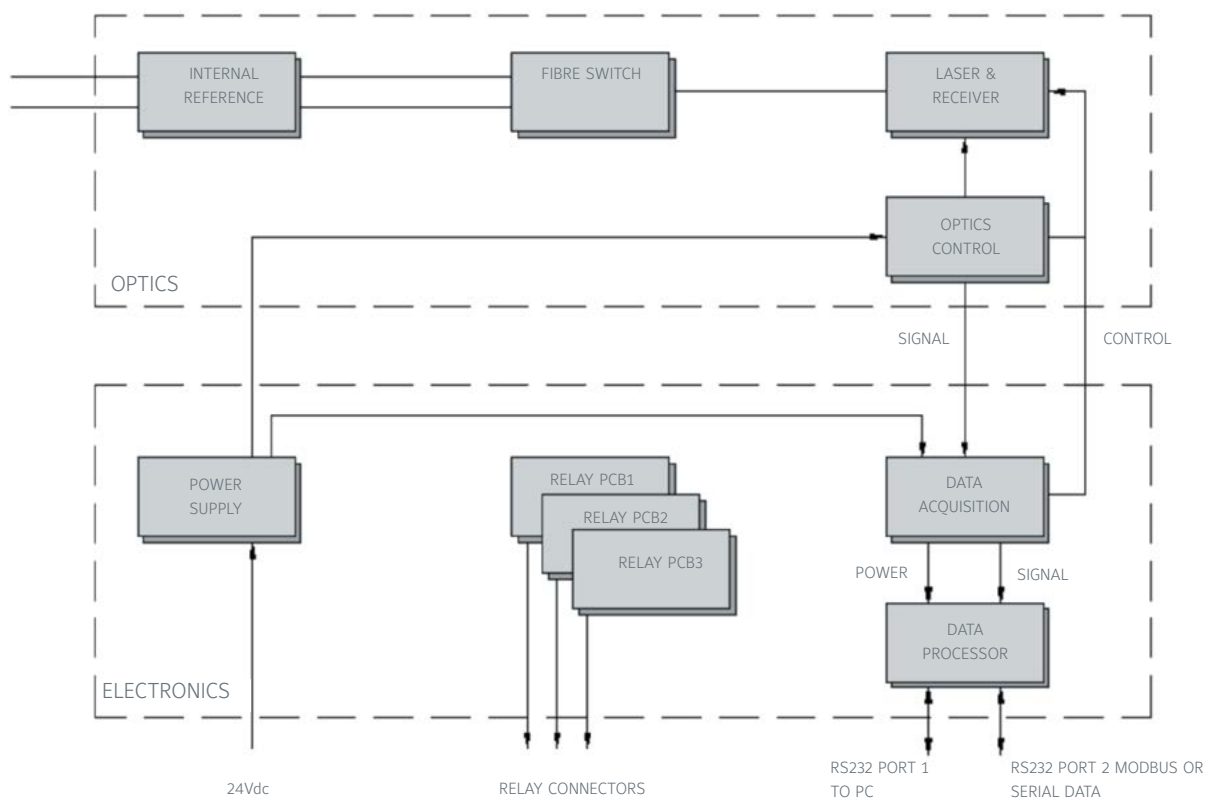

Fire Detection Product Catalogue

Standard communications grade optical fibre of the 62.5/125 graded index multimode type is used. The temperature range is predominantly a function of the coating used to protect the optical fibre as the fibre itself is well behaved over a wide temperature range. Special coatings have been tested down to -190°C and up to 460°C (metallic - available upon request) performance of the standard type is detailed overleaf. Optical fibre itself offers several advantages as a sensing medium. The signals are immune to electromagnetic interference thereby ensuring integrity of readings from electrically noisy areas. As no electrical current is used in the sensing fibre and the fibre is a relatively inert and dielectric (non-conducting) medium, it is safe technology to use in hazardous environments.

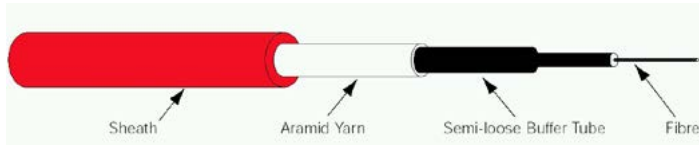

Sensor-Line

Outer sheath 3.6mm dia., Aramid fibres for strength, Optical fibre in gel filled tube

Specifications

Nominal Cable Dia.	5mm
Weight	2.3kg/m
Min. Bend Radius	63mm
Max. Tensile Load	100N
Operating Temp.	-20° to +70°C (continuous)
Installation Temp.	>10°C

Part Numbers

There are different models to suit specific length of risk to be protected. Please contact Johnson Controls for the appropriate order codes.

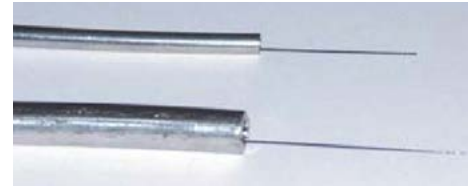

Sensor-Tube

Stainless steel tube 3.2mm dia. / 6.4mm dia.

Specifications

Nominal Cable Dia.	3.2 mm	6.4 mm
Wall Thickness	0.5 mm	0.9 mm
Weight	33 kg/km	121kg/km
Min. Bending Dia.	150 mm	150 mm
Max. Tensile Load	1971N	7080N
Operating Temp. ¹	-40° to +90°C (continuous)	
Max. Length (2 fibre)	2 km	10 km

1. For 125µm multimode fibre with acrylate coating, max. temp. is 150°C for 48 hrs. For polyimide coating, operating temp. is -185°C to +400°C.

Cable Options

FEATURES

HIGH SYSTEM INTEGRITY - LOOP BREAK RECOVERY

FIBRE OPTIC SENSOR LOOP UP TO 2km or 4km

PROGRAMMABLE RELAY CONTACTS

MODBUS OUTPUT PORT

AUTOMATIC FAILURE MODE ANALYSIS

SAFE LASER SOURCE

DIAGNOSTIC CAPABILITY

MODEM INTERFACE

BENEFITS

The system can be set to operate in either single ended or loop mode without any additional costly hardware. The system continuously monitors the integrity of the loop and continues to operate in the event of a cable fault. The system is designed with an automatic loop break recovery operation.

Very long distance (large areas) can be monitored using a single length of heat sensing cable. The hot spot identification on a 2km length of fibre optic sensing cable, is to within 1.25metres.

30 zonal relays ensure that the system can provide sufficient alarm notifications – typically directly to any Fire Alarm Control Panel. 2 relay contacts are reserved for system and sensor fault.

Permits connection of the system to any PLC (programmable logic controller) or DCS (distributed control system) using industry standard communications, thereby providing a very flexible system topology.

Cable faults are detected to an accuracy of ±1.25m. The control system is continuously monitoring and a full syntax of fault information is provided with the system.

In the event of a cable failure, where the laser light source may be exposed, the laser light is determined a safe source in accordance with IEC825.

Enables interrogation of the system to determine system status.

By using a remote PC with a dial up connection to the host PC on site, it is possible for system to be accessed from a remote location to help assist with on-line technical support.

- Low thermal mass for rapid response to temperature
- Low smoke halogen free jacket, with excellent flame retardancy. Suitable for all indoor applications
- Stainless steel clad fibre optic cable suitable for all harsh area applications
- Strong, lightweight and flexible
- Designed for ease of installation



Summary of Cable Features

Detector Test Equipment



Part Numbers

- 517.001.230 SOLO100 Telescopic pole 1.26m to 4.5m
- 517.001.226 SOLO101 Extension tube 1.13M long for use with S100 Telescopic extension pole
- 517.001.264 SOLO610 Equipment Bag and Pole Bag for Solo Detector Test Kit

Part Number
517.001.279
Solo Test Smoke
250ml can



Part Number
X900
Testifire Smoke/Heat/CO test kit for use with all detector ranges. Connects directly to S100/S101 poles



Part Numbers
X461 SOLO461 Cordless heat detector tester kit incl. SOLO460 tester, SOLO770 battery batons and SOLO724 charger. (Connects directly to SOLO100/101 poles).

517.001.273 SOLO770 Spare battery baton for use with SOLO 450/460 tester

X811 SOLO811 Smoke detector test kit incl. SOLO330 aerosol dispenser, SOLO200 detector removal tool, SOLO100 pole, SOLO101 extension & SOLO610 equipment bag. 800RT & SOLO704 ordered separately.

517.001.277 SOLO461 Heat Detector Tester

517.001.255 SOLO330 Aerosol dispenser

517.001.264 SOLO610 Equipment Bag and Pole Bag



Part Number
CRC-TEST
Test Smoke
71g can



Part Number
517.001.262
CO Detector Test
Gas, 120g can



Part Number
X811 Smoke Detector test kit
X822 Smoke & Heat Detector test kit



Part Number
517.001.224
SOLO704 Adaptor tube B - adapts SOLO100/101 pole sets for VIGILANT & SIMPLEX detector changers and testers



Part Number
516.800.917
800RT M600/M800 Detector removal tool. Requires Adaptor B and SOLO 100 pole



Part Number
517.001.240
SOLO200 Universal detector changer for use with various manufacturers detectors - not suitable for M600/900 series low profile. Connects directly to SOLO100/101 poles



Part Number
X61
Brandax VS Smoke Cartridge, 5 60g cartridges, dia 32x62mm, 55m³ smoke vol, 180-240s burn time



Part Number
X62
Ventilax Smoke Cartridge, 5 60g cartridges, dia 18x62mm, 17m³ smoke vol, 180-240s burn time



Part Number
X65-25
Splintax Smoke Matches, 25 1g matches, 0.7m³ smoke vol, 25s burn time



Part Number
X66
MiniAx Smoke Cartridge, 10 3g cartridges, dia 14x32mm, 2.5m³ smoke vol, 40s burn time

Smoke emitters are classified as Dangerous Goods for transport purposes.

Fire Detection Product Catalogue

SOLO Test Equipment for Point & Flame Detectors

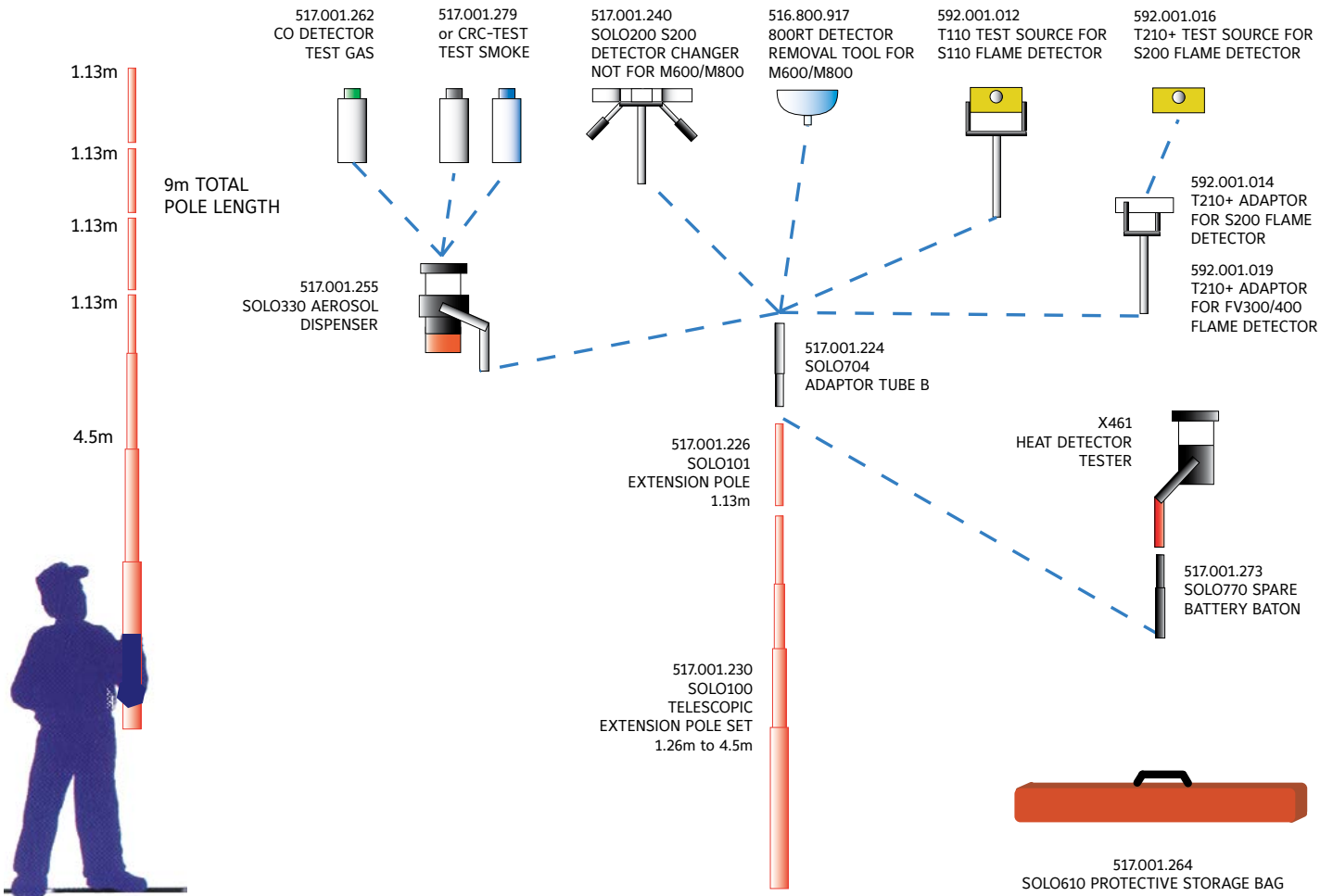

S200 Series Test Equipment & Accessories



Part Numbers

- 592.001.016 T210+ Test Source for use with SOLO 704 Adaptor Tube B and SOLO100/101 poles
- 592.001.014 T210+ Adaptor for S200 Detectors
- 592.001.019 T210+ Adaptor for FV300/FV400 Detectors

Part Number

- 517.001.184 S/S bracket assy for with all S100/200 Series detectors

Note the Test Source and appropriate Adaptor are required to test S200 and FV300/400 Detectors

S100 Series Test Equipment



Part Number







- 592.001.012 T110 Test Source for use with SOLO 704 Adaptor Tube B and SOLO100/101 poles

Part Numbers

- 592.001.010 T110/T210 PP9 NiMH Battery and Charger kit
- 592.001.012 T110 Test Source for use with SOLO 704 adaptor tube B and SOLO100/101 poles

This page is intentionally left blank.







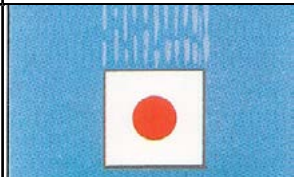

International Protection Ratings

	TEST	PROTECTION
X	No test applied	No specific protection
0	No test applied	Inherent degree of protection
1		Protected against solid objects larger than 50mm (e.g. accidental contact with hand)
2		Protected against solid objects larger than 12mm (e.g. finger of the hand)
3		Protected against solid objects larger than 2.5mm (e.g. tools, wires)
4		Protected against solid objects larger than 1mm (e.g. fine tools and wires)
5		Protected against dust. Prevent entry in sufficient quantity to interfere with satisfactory operation
6		Completely protected against dust

Additional letters

The standard defines additional letters that can be appended to classify only the level of protection against access to hazardous parts by persons:

















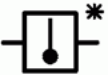

Level	Protected against access to hazardous parts with
A	back of hand
B	finger
C	tool
D	wire

	TEST	PROTECTION
X	No test applied	No specific protection
0	No test applied	Inherent degree of protection
1		Protected against drops of water falling vertically
2		Protected against drops of water falling at up to 15° from the vertical
3		Protected against spraying water at up to 60° from the vertical
4		Protected against splashing water from all directions
5		Protected against jets of water from all directions
6		Protected against jets of water of similar force to heavy seas
7		Protected against the effects of immersion
8		Protected against the effects of submersion

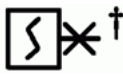
To Australian Standard AS1939-1990 'Classification of Degrees of Protection' provided by enclosures for electrical equipment.

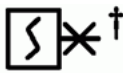
Refer to AS 60529-2004 Degree of protection provided by enclosures (IP Code) for test requirements for the IP classification of enclosures.

Symbols

	Heat detector (exposed or ceiling mounted)		Optical beam type smoke detector (transmitter)
	Heat detector in concealed space		Optical beam type smoke detector (receiver)
	Heat detector within air duct		Heat alarm
	Line detector		Smoke alarm
	Smoke detector (exposed or ceiling mounted)		Electromagnetic holder
	Smoke detector in concealed space		Remote visual indicator
	Smoke detector within air duct		Flame detector
	Smoke detector with sampling device		Gas fire detector
	Aspirated smoke detector system		End-of-line device
			

Symbols



Fire indicator panel



Loud speaker



Sub indicator panel

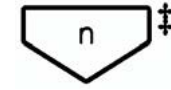

Device address



Remote control equipment



Alarm zone



Repeater panel



Circuit wiring



Addressable device



Flow switch



Storage battery



Pressure switch



Fire alarm bell



Manual call point



Visual warning device



Monitored valve

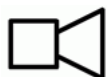

Alarm sounder



Multi-sensor detector

* Heat detector type (e.g. TA, TB, etc. for AS 1603.1 detectors or A1, B, etc. for AS 7240.5 detectors)

† Type of smoke detector e.g. I = Ionisation, P = Photoelectric, L = Laser, S = Scattering, G = Gas, J = Jet, M = Multi-sensor, N = Nuclear, R = Radioactive, T = Thermal, V = Visible, W = Water, X = X-ray, Y = Yttrium, Z = Zirconium

§ Type of flame detector e.g. IR = Infrared, UV = Ultraviolet

& Type of gas detector, e.g. CO

Reference Tables

Conventional (non-addressable) Detector Selection Chart

	Environment	Very Clean and Dry	Benign Moderately Clean Regulated Temperature	Dirty - Smoky	Dusty and/or Humid	Hot and Smoky	Open Areas
	For Example	- Clean Room - Data Processing	- Office - Light Industrial - Hospital - Residential - Passenger Accommodation	- Loading Bay/ Warehouse with diesel forklifts etc - Heavy Industrial - Ferry (car deck)	- Livestock Pen - Mill - Laundry - Changing Room	- Kitchen - Engine Room - Test Beds	- Atrium - Theatre - Hanger - Oil Rig - Turbine Hall
Fire Loading	Probable Risk						
Electronic Equipment, Electrical Switchgear, Electric Motors, Cable, Conduit	Cable pyrolysis (toxic fumes), Electrical Arcs (ignition source), Associated electrical fire	Aspirated Photo Ionisation	Aspirated Photo	Photo	-	-	Aspirated Flame Beam
Fabrics, Clothes, Soft Furnishings, Animal Bedding, Wood Shavings	Smouldering (difficult to locate-toxic fumes), Likelihood of flashover	-	Aspirated CO/Heat Photo	CO/Heat Photo	CO/Heat Photo	CO/Heat Heat	CO/Heat Flame Beam
Flammable Liquids, Paints, Solvents, Flammable Gas, Unstable Chemicals, Foodstuffs	Flaming fire, Rapid build-up of dense smoke, High temperature, Associated explosion danger	Flame Ionisation Photo CO/Heat Heat	Flame Ionisation Photo CO/Heat Heat	Flame Ionisation CO/Heat	Flame CO/Heat	Flame Heat	Flame Beam
General, Organic Waste, Animal Fodder, Wooden Structures, Solid Fuels	Smoke and Flame, Initially fairly slow but high temps. once established	-	CO/Heat Photo Ionisation	CO/Heat Heat	CO/Heat Heat	Heat CO/Heat	CO/Heat Flame Beam
Plastic, Chemicals, Machinery, Building Materials, Unknown Contents	Type of risk may vary as can the type of fire (may require a mix of detection types)	Aspirated CO/Heat Photo Ionisation Flame Heat	CO/Heat Photo Ionisation Heat Flame	CO/Heat Photo Ionisation Flame Heat	CO/Heat Flame Heat	Heat CO/Heat Flame	Flame CO/Heat Beam

This table is for general guidance only and should not be used as a substitute for expert advice. Detectors in **bold** typeface indicate the most suitable - other types indicated may not be optimum for reasons of performance or cost, but real situations may require a combination to cover likely risks.

MX Ancillary Device / MX Panel Compatibility

Compatibility	MX1	MX4428	4100ESi
CP820 Call Point - Indoor	√	√	√
CP830 Call Point - Outdoor	√	√	√
CIM800 Contact Input Module	√	√	√
DDM800 Universal Fire & Gas Detector Module	√	√	√
DIM800 Detector Input Module	√	√	√
LIM800 Loop Isolator module	√	√	√
LPS800 Loop Powered Sounder Module	√	√	-
MCP820 S/C Isolator Call Point - Indoor	√	√	-
MCP830 S/C Isolator Call Point - Outdoor	√	√	-
MIM800 Mini Input Module	√	√	√
MIO800 Multi Input/Output Module	√	-	√
QIO800 Quad Input/Output Module	√	-	-
QMO800 Quad Monitored Output Module	√	-	-
QRM800 Quad Relay Output Module	√	-	-
RIM800 Relay Interface Module	√	√	√
SIO800 Single I/O Module	√	-	-
SNM800 Sounder Notification Module	√	√	√
VIO800 VESDA Input Module	√	-	√

Fire Detection Product Catalogue

MX Detector Selection Chart

	Environment	Very Clean and Dry	Benign Moderately Clean Regulated Temp.	Dirty - Smoky	Dusty and/or Humid	Hot and Smoky	Open Areas
Fire Loading	For Example Probable Risk	- Clean Room - Data Processing	- Office - Light Industrial - Hospital - Residential - Passenger Accommodation	- Loading Bay/ Warehouse with diesel forklifts etc - Heavy Industrial - Ferry (car deck)	- Livestock Pen - Mill - Laundry - Changing Room	- Kitchen - Engine Room - Test Beds	- Atrium - Theatre - Hanger - Oil Rig - Turbine Hall
Electronic Equipment, Electrical Switchgear, Electric Motors, Cable, Conduit	Cable pyrolysis (toxic fumes). Electrical Arcs (ignition source). Associated electrical fire.	Aspirated 814P/814PH 814I	Aspirated 814P/814PH	814P/814PH	–	–	Aspirated Flame Beam
Fabrics, Clothes, Soft Furnishings, Animal Bedding, Wood Shavings	Smouldering (difficult to locate-toxic fumes). Likelihood of flashover.	Aspirated 814P	814CH 814P/814PH	814CH 814P/814PH	814CH 814P/814PH	814CH 814H	814CH Flame Beam
Flammable Liquids, Paint, Solvent, Flammable Gas, Unstable Chemicals, Foodstuffs	Flaming fire Rapid build-up of dense smoke. High temperature Associated explosion danger.	Flame 814P/814PH 814I 814CH 814H	Flame 814P/814PH 814I 814CH 814H	Flame 814CH 814H	Flame 814CH 814H	Flame 814H	Flame Beam
General Organic Waste, Animal Fodder, Wooden Structures, Solid Fuels	Smoke and Flame. Initially fairly slow but high temps. once established.	–	814CH 814P/814PH 814I	814CH 814H	814CH 814H	814H 814CH	814CH Flame Beam
Plastic, Chemicals, Machinery, Building Materials, Unknown Contents	Type of risk may vary as can the type of fire (may require a mix of detection types).	Aspirated 814CH 814P 814I Flame 814H	814CH 814P/814PH 814I 814H Flame	814CH 814P/814PH 814I Flame 814H	814CH 814P/814PH Flame	814H 814CH Flame	Flame 814CH Beam

This table is for general guidance only and should not be used as a substitute for expert advice. Detectors in **bold** typeface indicate the most suitable - other types indicated may not be optimum for reasons of performance or cost, but real situations may require a combination to cover likely risks.

VIGILANT/Minerva Sounder Base Selection Guide

Product Code	577.001.035	516.800.910	814SB	516.800.911
Description	601SB Collective	802SB MX Low Power	814SB	901SB Universal
CIE	Conventional only	MX Only	MX Only	Minerva Addressable/ MX
Powered From	24Vdc	MX Addressable loop	MX Addressable loop	24Vdc
Detector required to Operate?	No	Yes	Yes	Yes
Park Clip Colour	Green	White		Blue
Current @ 68dBA (min. volume)	1.2mA	1.2mA	9mA	1.2mA
Current @ 90dBA (max. volume)	6.8mA	6.8mA	15mA	6.8mA
Current @ 100dBA (fixed volume)	-	-	-	-
Dutch Slow Sweep(7)	Yes	Yes	-	Yes
Temporal 4	Yes	Yes	-	Yes
Slow Sweep(3)	Yes	Yes	Yes*	Yes
March Time Beep(25)	Yes	Yes	-	Yes
March Time Beep(26)	-	-	-	-
Fast Sweep(2)	Yes	Yes	Yes**	Yes
Temporal 3 (ISO)	Yes	Yes	-	Yes
Alternating 2(11)	Yes	Yes	-	Yes
Alternating 2(9)	-	-	-	-
Continuous(14)	Yes	Yes	-	Yes
Continuous	-	-	Yes***	-

2, 3, 7, 9, 14, 25, 26 = ROSHNI tone number

* Slow sweep = 5 Hz

**Fast Sweep = 15 Hz

*** Continuous Sweep = 825 Hz

Spare Parts List

F3200 Comprehensive Spares List

CL0423	Transformer, 240VAC 2.5A 31V RMS	KT0274	Kit,F3200 FIP,AS1603.4 To AS4428.1 Conversion
FA1223	Fab, 1931-1-1 Keypad Membrane (AS1603)	KT0429	Software, F3200/NDU AS4428 Controller V5.xx (req. >1931-111B)
FA1227	Fab,1931-24,F3200 9.5U Blank Panel,plastic	KT0478	Kit AS1668 5 Way Fan Control Module c/w 2xFRC 2m
FA1235	Fab,1919-27-5,F3200,15U Std Flush Surround (P)	KT0512	Kit,AS1668 4 Way Fan Control+master c/w 2xFRC 2m
FA1298	Fab,1919-27-6,F3200,8U Small Flush Surround (P)	LM0041	Loom,1888-58,Prog Port to DB9 Serial (Printer/PC to Controller)
FA1299	Fab,1919-27-7,F3200,8U + 8U Batt Box,flush Surround (P)	LM0042	Loom,1888-62,Prog Port to DB25 Serial (Printer/PC to Controller)
FA2150	AS4428.1 Keypad Membrane Overlay Only	LM0044	Loom,1901-81-1,display Extender FRC,2m
FP0475	16 Zone LED Display Extender Kit,1901-26 (incl. PA0454, LM0046, H'ware, Not For First LED Display)	LM0045	Loom,1901-81-2,display Extender FRC,5m
FP0553	F3200 8 Z Input Expansion Kit (incl. PA0492, LM0053, 8xEOLR)	LM0046	Loom,1901-81-3,display Extender FRC,0.5m
FP0554	F3200 8 Relay Expansion Kit (incl. PA0493, LM0053, 8x Minijump Links)	LM0049	Loom,1901-81-4,display Extender FRC,0.25m
FP0556	F3200 15U Cabinet,empty,c/w Door,window,lock	LM0053	Loom,1931-28-1,F3200 20 Way FRC,300mm (Interconnecting 8Z-Modules, Incl. in FPO553, 554)
FP0557	F3200 15U Cabinet,empty,c/w Blank Outer Door	LM0092	Loom 1901-88 Controller to 1st Display, FRC, 1.2m (Display Bd to Controller, for Display Bd furthest LHS)
FP0576	F3200,8U Battery Box (No Window)	ME0060	Mech Assy,1901-79,RAC Cabinet,7U LED Hinged Inner Door
FP0584	F3200,8U Empty Cabinet,full Window	ME0072	Mech Assy,1931-70,F3200 Rack Mtg Gearplate
FP0704	Network Upgrade Kit V2.06 (AS1603)	ME0098	Mech Assy,1931-116,F3200 AS4428.1 Cntrl,4U Hinged (incl PCB)
FP0731	RDU To NDU Upgrade Kit	ME0250	Mech Assy,1919-35,RAC Cabinet,IP65,20U x 200 (i.e. Waterproof)
FP0780	F3200 AS4428 Fip,no Cardframe, 24 Zone Max,3A 15U	ME0258	Mech Assy,1919-21-2,RAC Cabinet,1u Shelf,135 Deep (incl. hrdware)
FP0781	F3200 AS4428 Fip,c/w Cardframe,64 Zone Max,3A, 15U	ME0439	Mech Assy,1931-123,AS4428 2 Zone Gas Cntrl 7U Door
FP0782	F3200 AS4428 Fip,no Cardframe,24 Zone Max,6A, 15U	ME0440	Mech Assy,1931-123,AS4428 3 Zone Gas Cntrl 7U Door
FP0783	F3200 AS4428 Fip,c/w Cardframe,64 Zone Max,6A, 15U	ME0441	Mech Assy,1931-123,AS4428 4 Zone Gas Cntrl 7U Door
FP0784	F3200 AS4428 Fip,8U, MAF/PSU,3A, 8 Zone, 8U	ME0442	Mech Assy,1931-124,AS4428 1U 1 Zone Gas Cntrl Pnl
FP0790	NDU AS4428,Network Display,full Cab,MAF/PSU,3A	ME0457	Mech Assy 1982-40 MX1 4U 5x 16 Zone Display Door (Suit FP1002)
FP0791	NDU AS4428,Network Display,slimline,surface	ME0472	Mech Assy, MX1 2U Door,4x AS1668 + Common
FP0792	NDU AS4428,Network Display,slimline,flush	PA0443	PCB Assy,1841-18,contact Conversion Module
FP0793	NDU AS4428,Network Display,deep Slimline,c/w I-HUB	PA0491	PCB Assy, 1931-3 AS1603 MAF/PSU 3A
FP0794	NDU AS4428,Network Display,4U 19" Module	PA0703	PCB Assy,1931-27,F3200 Remote I/F Bd
FP0795	F3200 AS4428 Network Upgrade Kit,V3.xx (SF0222,IC0358,PA0773,LM0091,LT0330)	PA0707	PCB Assy,1931-39,F3200 3A Rectifier Bd (half PA1030)
FP0876	F3200 AS4428 FIP,8U Cab,3A,1U Gas Ctl,pre Prog	PA0773	PCB Assy,1901-139-3,RS485 Comms Bd,CMOS;FRC Only
FP0877	F3200 AS4428 FIP,15U Cab,6A,1U Gas Ctl,pre Prog	PA0804	PCB Assy, 1931-84-1 AS1603 Ndu Controller, No S/w
FP1002	MX1 16 Zone LED Display Extender F3200/NDU AS4428.1 (incl. FP1002, LM0291, LM0339)	PA0809	PCB 1931-2 MAF/PSU 6A AS1603
FZ3031	Kit,F3200,16 Zone LED Display,LHS Position (FP0475, 1.2m FRC LM00492)	PA0810	PCB 1391-44 6A FET & Rectifier Bd (half of PA1030)
FZ9002	19" Rac,7U Blank Hinged Inner Door	PA0873	PCB Assy,1931-3-3,F3200 AS4428 MAF/PSU,3A
IC0320	PA0482 U3 EEPROM	PA0874	PCB Assy,1931-3-4,F3200 AS4428 MAF/PSU,6A
IC0358	F3200 U13 DUART	PA0909	PCB Assy,1931-111-1,F3200 AS4428 Controller, No S/w
KT0072	Kit,F3200,cardframe Upgrade	PA1030	PCB Assy, 1931-133 3A Rect & 6A FET and Rect (PA0707/PA0810)
KT0112	Kit,1945-1-2,AS1668 Control Module,Type 2	RR0917	Resistor, PTC, Overload Protect,30V,6A
KT0113	Kit,1945-1-3,AS1668 Control Module,Type 3	SF0427	Software,F3200 PAL,V1.10
KT0199	Kit,ASE,3U 19" Rack Mounting Front Panel	SW0121	PSU Mains Switch DPST 6A 250VAC
KT0212	Kit,V-MODEM,2 up,3U 19" Rack Mtg Front Panel	SW0030	F3200 Door Switch Assembly 1931-95
KT0271	Kit,F3200,AS1603.4 V2.xx To V3.xx Std Upgrade		
KT0272	Kit,F3200 AS1603.4 V2.xx Net To V3.xx Net Upgrade		
KT0273	Kit,NDU AS1603.4 V2.xx To V3.xx S/W Upgrade		

MX4428 Comprehensive Spares List

FA1174	MCP Blanking Plate	PA0481	F4000 RZDU/RS232 I/F PCB 1901-100 incl LM0061
FA1193	7U Blank Inner Door	PA0482	F4000 Memory LCD I/F PCB 1901-102
FA2150	MX4428 Keyboard Membrane Overlay	PA0487	Banked EPROM Emulator PCB 1901-113
FP0575	MPR Responder in Box (PA0713 PCB only)	PA0711	RS485 comms CMOS PCB 1901-139-1
FP0824	MPX Responder in box (PA0893 PCB only)	PA0713	MPR Responder PCB Only 1901-141
FP0882K	F4000 AS1603 Power Supply 24V 5A	PA0773	RS485 coms CMOS PCB FRC 1901-139-3
FP1007	F4000 AS1603 Batt Test Kit for ME0476	PA0799	PCB PTM no software 1931-84-3
HW0040	Lock A/CR16/01/3B/N04 003 Keyed	PA0890	PCB AS4428 keyboard/LCD module
IC0320	F4000 IC 28C64 8K EEPROM	PA0891	PCB AS1603 keyboard/LCD module
IC0414	IC 28C010 EEPROM U2 PA0482	PA0893	MPX Responder PCB only 1901-213
KT0178	F4000 Point Text Upgrade (IC0414(U2),IC0320(U4))	PA0906	68HC11 Micro PCB 1901-210
LM0041	Programming Cable DB9 to CIE	PA0951	MX4428 Main Bd, c/w PA0906, no s/w 1901-12
LM0073	20W FRC Keybd to Main bd 1.45m	PA1040S	MX4428 Main board c/w Mem/LCD I/F, S/W
LM0083	20W FRC Keybd to Main bd 0.7m	SF0238	MPR Software V3.00
ME0060	7U Display Door 1901-79	SF0261	F4000 Master Software V2.39N
ME0351	F4k small cab inner door AS1603 - no replacement avail	SF0349	MX4428 Master Software V3.21N (U7 PA0951, U1 PA0482)
ME0355	4U door, AS4428 keypad, PA0890 PCB	SF0350	MX4428SL Master Software V3.21S Single Loop
ME0356	4U door AS1603 keypad, PA0891 PCB	SM0031	FA1201 F4000 LCD keyboard overlay (AS1603.4)
ME0444	4U door & AS4428 keypad (no PCB)	SM0032	FA1159 F4000 non LCD keyboard overlay (AS1603.4)
ME0476	MX4428 Power Supply 24Vdc 5A PSU - replaces FP0874	SW0121	PSU Mains Switch DPST 6A 250VAC
PA0449	F4000 Power Supply PCB 1901-2		
PA0463	F4000 Loop Booster PCB 1901-35		

Spare Parts List

QE90 Comprehensive Spares List

FA1852	QE90 6U Amp Rack Cover Smoked Perspex	ME0381	MECH ASSY, QE90 ECP + 2Z KEYBOARD REPLACE, 3WIP/Z - (Inner Door with Keypad (for >21U panel) no PCB)
FA1995	ECP Door only 16U All-in-One Panel E/8/3WIP/Zone	ME0382	MECH ASSY, QE90 ECP 8 ZONE KEYBOARD REPLACE, 3WIP/Z (Inner Door with Keypad (for >21U panel) no PCB)
FA2027	FAB, 699-237, QE90 ECP+2Z Keypad, 3WIP/ZONE - Keypad only	PA0484	QE90 PCB 1929-1 PAGING CONSOLE
FA2029	FAB, 699-238, QE90 8Z EXTENDER Keypad, 3WIP/ZONE	PA0623	PCB ASSY, QE90 ECP9702-2 EVAC CNTL PANEL 3WIP/ZONE with socket for site-specific WIP s/w
FP0539	QE90 PAGING CONSOLE	PA0642	PCB ASSY, QE90 WIPS2000 WIP SLAVE, OV REF Replaces PA0622
FP0546	FP, F4000 THERMAL PRINTER	PA0643	PCB ASSY, QE90 ECP9702-2 EVAC CNTL PANEL 3WIP/ZONE incl. WIDGET - see also PA0623
FP0752	FP, QE90, PRINTER OPTION KIT, 699-244	PA0646	PCB ASSY, QE90 ALIM9706, AUDIO LINE ISOLATOR MODULE
FP1067	QE90 4U MODULE BLANK UPGRADE KIT	PA0647	PCB ASSY, QE90 AMP200 200W AMPLIFIER MODULE
FP1068	QE90 FIP/BGA MASTER UPGRADE KIT	PA0648	PCB ASSY, QE90 TRAN200 200W TRANSFORMER MODULE
FP1069	QE90 FIP/BGA EXTENDER UPGRADE KIT	PA0649	PCB ASSY, QE90 SPIF9709 SECONDARY PANEL INTERFACE
FP1070	QE90 STROBE MASTER UPGRADE KIT	PA0650	PCB ASSY, QE90 EAMP9001 4 ZONE POWER AMP
FP1071	QE90 SPIF MODULE UPGRADE KIT	PA0651	PCB ASSY, QE90 FIB8910 FIP/BGA MASTER (DIN RAIL)
FP1072	QE90 ECM MODULE + LOOMS (NO SOFTWARE) UPGRADE KIT	PA0652	PCB ASSY, QE90 FIPE9004 FIP/BGA EXTENSION (DIN RAIL)
FP1073	QE90 WIP SLAVE + TERM BOARD UPGRADE KIT	PA0653	PCB ASSY, QE90 EMSP8911-2 DISPLAY KBD 3WIP/ZN superseded by ME0205 exc. for pre-July 2009 QE90 in 21U cab.
FP1074	QE90 100W AMP + TRANSFORMER UPGRADE KIT	PA0654	PCB ASSY, QE90 EMUX9002 MULTIPLEXER superseded by PA0758
FP1075	QE90 2x50W AMP + TRANSFORMER UPGRADE KIT	PA0656	PCB ASSY, QE90 RING9006 MASTER PHONE RING
FP1076	QE90 2x25W AMP + TRANSFORMER UPGRADE KIT	PA0657	PCB ASSY, QE90 SE9004 SIGNAL INTERFACE (DIN RAIL)
FP1077	QE90 4x10W AMP + TRANSFORMER UPGRADE KIT	PA0660	PCB ASSY, QE90 BPLN2000 BACKPLANE
FP1078	QE90 4x25W AMP + TRANSFORMER UPGRADE KIT	PA0662	PCB ASSY, QE90 WIPS9004 WIP SLAVE use PA0642 with PA0916
FP1079	QE90 200W AMP + TRANSFORMER UPGRADE KIT	PA0679	PCB Assy QE90 24V 3A PSU 699-160
FP1080	QE90 5 MODULE HINGE UPGRADE KIT	PA0684	PCB ASSY, TRAN9304-1, 4 X 10W MODULE WITHOUT RELAYS superseded by PA0795 or PA0796
FP1081	QE90 6 MODULE HINGE UPGRADE KIT	PA0687	PCB ASSY, TRAN9304-4, 2 X 25W MODULE WITH RELAYS superseded by PA0794
FP1082	QE90 7 MODULE HINGE UPGRADE KIT	PA0689	PCB ASSY, QE90, WLED9307, WIP FLASHING LED
FP1083	QE90 8Z DISPLAY EXTENDER + LOOMS UPGRADE KIT	PA0690	PCB ASSY, QE90 HAMP9308 2 X 50W AMPLIFIER MODULE
FZ9026	4U Module Blank	PA0691	PCB ASSY, QE90 HTRN9308-1 2X50W TRANSFORMER MODULE
HW0040	003 Lock Tumbler & Keys	PA0692	PCB ASSY, QE90 HTRN9308-2 1X100W TRANSFORMER MODULE
KT0102	Hinge Kit - 3 Modules 12U	PA0695	PCB ASSY, QE90 HTMS9408-1, 2*50W XFMR MOD MUSIC SWCH
KT0103	Hinge Kit - 4 Modules 16U	PA0696	PCB ASSY, QE90 HTMS9408-2, 100W XFMR MOD MUSIC SWCH
KT0104	Hinge Kit - 5 Modules 20U	PA0697	PCB ASSY, QE90 STRM9502 STROBE/RELAY MODULE (DIN RAIL)
KT0120	Hinge Kit - 6 Modules 24U	PA0698	PCB ASSY, QE90 ECM9603 EVAC COMMUNICATION MODULE
KT0105	Hinge Kit - 7 Modules 28U	PA0730	PCB ASSY, 1922-11-2, 24V GENERAL PURPOSE RELAY BD
KT0546	Kit, PSU2412 Additional Circuit Breaker incl. Loom & Mounting	PA0758	PCB ASSY, QE90, EMUX9601, MULTIPLEXER 16SEC SPEECH
KT0169	KIT, QE90 ECP, ICs FOR RS232/PRINTER	PA0759	PCB ASSY, QE90, EMUX9601, MULTIPLEXER 60SEC SPEECH
LM0043	LOOM, 699-090-1, FRC, 20W, 0.07m, QE90 FIP EXTENDER	PA0792	PCB ASSY, TRAN9705-2, 4x25W MODULE C/W RELAYS
LM0047	LOOM, 699-089, FRC, 26W, 1.3m, TWISTED, QE90 TRAN	PA0794	PCB ASSY, TRAN9705-4, 2x25W MODULE C/W RELAYS
LM0048	LOOM, 699-090-2, FRC, 20W, 0.25m, QE90 DISPLAY EXTDR	PA0795	PCB ASSY, TRAN9706-1, 4x10W MODULE WITHOUT RELAYS (can also use PA0796)
LM0060	LOOM, 699-087, FRC, 34W, 1.2m, QE90	PA0796	PCB ASSY, TRAN9706-2, 4x10W MODULE C/W RELAYS
LM0063	LOOM, 699-228, QE90 ECP POWER LOOM, UP TO 21U	PA0916	PCB ASSY, QE90 WTRM2000, WIP TERMINATION (DIN)
LM0065	LOOM, 1901-174, RS485 Comms BD (also ECM), 10 W FRC TO DB9	SF0132	SOFTWARE, QE90, EMUX9601, ALERT/EVAC 60SEC SPEECH
LM0076	LOOM, 1922-25, ECM PROG, DB9F to DB9F, NULL MODEM	SU0168	SUNDRY, MICROPHONE, GOOSENECK DM521B
LM0077	LOOM, 1922-26, RZDU RS232-ECP HIGH LEVEL LINK, 2.9M	SU0169	SUNDRY, MICROPHONE, DESK PM600D
LM0078	LOOM, 1922-27, RZDU RS232-ECM HIGH LEVEL LINK, 3M	SW0018	Keypad only-no loom (incl 003 keys)
LM0098	LOOM, 699-087, FRC, 34W, 0.8m, QE90		
LM0100	LOOM, 699-087, FRC, 34W, 1.5m, QE90		
LM0101	LOOM, 699-241, FRC, 26W, 0.45m + 0.9m, QE90		
LM0131	LOOM, SERIAL PRINTER CABLE, DB9M to(x)DB9M+DB9F		
ME0200	QE90 CARDFRAME INCLUDING BPLN2000 PCB		
ME0207	QE90 ECP ASSEMBLY 3 WIP PER ZONE incl. PCB		
ME0208	QE90 FLUORESCENT LIGHT		
ME0211	QE90 24V 12A PSU, PSU308 superseded by ME0333		
ME0212	QE90 24V 3A PSU, PSU2403 superseded by ME0331		
ME0213	QE90 NOISE CANCELLING MICROPHONE INCLUDING DIN PLUG		
ME0273	QE90 21U Outer Door, Full Window		
ME0297	QE90 AUTO/MAN/ISOL Keypswitch (incl loom, connector, SW0018)		
ME0330	MECH ASSY, 1966-6, PSU2406, BRICK		
ME0331	MECH ASSY, 1966-21, PSU2406, 2U RACK MTG		
ME0333	MECH ASSY, 1966-22, PSU2412, 2U RACK MTG		

MX1 Spares List

FA2489	MX1 AS4428.3 Membrane Keyboard	LT0360	MX1, Installation Guide
FP0913	Replacement MX1 LCD Module Kit	ME0448	MX1 PSU Assy
FP0950	MX1 Loop Card (PA1052) Kit	ME0450	MX1 Door c/w Hinges
FP1002	MX1 16 Zone LED Display Extender	ME0457	MX1 4U, 80 Zone Display Door
LB0600	Label, MX1, blank zone label, grey (sheet of 5 supplied with panel)	ME0464	MX1 4U Door c/w Keypad (no PCB or LCD)
LM0169	MX1 2nd Loop to Controller Loom FRC 10way Style C 400mm	ME0465	MX1 4U LCD Door Tested (incl. PCB & FRC)
LM0291	MX1 Display Interconnect Loom FRC 26way Style B 230mm	PA1081	PCB assy 1982-2, MX1 Controller
LM0319	MX1 Main Bd to T-GEN Loom	PA1057	PCB assy 1982-64 MX1 LCD/Keyboard AS4428.3
LM0323	MX1 LCD to keyboard Loom 16way FRC Style D 125mm	SF0305	S/w, MX1 CPLD V1.00
LM0324	MX1 Keyboard to Main Brd Loom 10way FRC Style B 1m	SF0392	S/w, MX1 Loop Card Flash
LM0339	Loom, FRC, MX1 to 1st Display Board	SF0407	S/w, MX1 FPB Keyboard Controller Flash
LT0344	MX1, Operator Manual	SF0412	S/w, MX1 Mainboard V1.3x Flash

Spare Parts List

4100 Comprehensive Spares List

4100 Front Panel Controls

650-127	4100U/ES-S1 replacement LCD, incl. keypad & metalwork
566-284	4100U/ES 2 x 40 LCD / keypad PCB, no LCD no metalwork
4100-1277	8 Red & 8 Yellow LED Module
4100-1279	Single Blank Display Cover (4100ES)
4100-1280	8 Pushbutton 8 Red LED Module
4100-1282	8/16 Push Button/ Red-Yellow LEDs
4100-1281	8 Pushbutton 8 Yellow LED Module
4100-1284	8/16 Push Button/ Red-Green LEDs
4100-1287AU	4-way 1668 Networked Fan Control Module
4100-1288	64/64 LED Switch Controller (1st controller per bay)
4100-1289	64/64 LED Switch Controller (2nd controller per bay)
4100-KT0476	Half Bay Blank Display Cover (4100ES)
4100-ME0456	Fan Control Module 4 sets of fan control
4100-ME0498	InfoAlarm 8U LCD and hinged door
4100-7155K	InfoAlarm LCD on swing down frame kit this is a direct swap in an S1 panel
4100-0640	InfoAlarm memory expansion board required for aftermarket NDU conversions
4100-ME0510K	InfoAlarm+ Colour touch screen display on 7U 19inch black door
4100-KT0486	4100U/ES 4U 19 inch rack replacement LCD, incl. keypad and metalwork

Rear Panel PDI (can only be fitted in 4100ES Bay)

4100-3107AU	IDNET+ Module AU S/W
4100-3109AUK	IDNet2 250 Point 2-channel IDNET Addressable Loop PDI
4100-3110AUK	IDNET2+2 250 Point 4-channel IDNET Address. Loop PDI
4100-3204	4xRelay Card 4xFB Flat Version
4100-3206	8x Relay Card Flat Version
4100-5013	8 Zone / Relay Card
4100-6070	Fire Panel Internet I/F Module (double size can be mounted in Legacy Bay)
4100-0620	4100ES Basic Transponder Interface Card (TIC)
4100-6301	Duplex Single Mode Fibre Media left port card
4100-6302	Duplex Single Mode Fibre Media right port card
4100-6303	Duplex Multi Mode Fibre Media left port card
4100-6304	Duplex Multi Mode Fibre Media right port card
4100-6077AUK	4100ESi MX loop card (does not require isolators)
ME0516	4100ESi MX dual loop card bracket
ME0504K	APS 10A power supply suits 4100ESi BTO systems (not suitable for 15U Compact panels)
ME0508K	LPS 10A power supply suits 4100ESi 15U Compact panels
LM0596K	4100ESi 15U Compact panel battery lead set
PA1098K	4100ESi Short PDI back plane spare part
4100-6046V	VESDA High Level Interface card PDI

Rear Panel Legacy

ME0455	250 Point IDNET Addressable Loop Legacy Mounting
4100-MXPK	4100MXP MX Responder on metal bracket (1 slot)
4100-0110K	MAPNET II Addressable Loop
4100-0111	MAPNET II QUAD Isolator
4100-0113	RS232 Modem Interface
4100-0122	Remote Interface Card (RIC) for Miniplex RTU
4100-0154	VESDA HLI
4100-9848AU	4100ES XSPS Power Supply (incl. IDNET Addr. Loop)
41000157AK	8A Power Supply / Charger (AS4428 approved)
4100-ME0470	5A Vigilant PSU / Charger (AS4428 approved)
4100-0301	64/64 LED Switch Controller
4100-0302	24 Point I/O Module
4100-0304	Remote Unit Interface
4100-3003K	8XSPDT,3A,24VDC Relay module
4100-3024	24 I/O Relay Motherboard + (4100-0302)
4100-4321	6 Supervised Relays
4100-5004	8 AZF Monitor Zone
4100-0451	Panel Mounted Printer
8566-719	4100ES CPU Module Spare Part
4100-0160K	Fire Panel Internet I/F Module

Brigade Interface

4100-0199	3U Brigade Kit-ASE Bracket Grey
4100-KT0212	3U 2x ASE / V-MODEM Bracket Grey
4100-FZ9028	3U WA/Cube ASE Brkt Grey
FP0935	4100ES-S1 ASE Door Kit
FP0937	4100ES-S1 WA/Cube ASE Door Kit
ME0512K	4100ESi Cube ASE & Mic. Brigade Kit (uses 6 slots of a 7U display door) Black
ME0513K	4100ESi Centaur II ASE & Mic. Brigade Kit (uses 6 slots of a 7U display door) Black

RTU Cabinets

SZ9008	8U RTU Cabinet No PSU (Requires TIC or RIC)
SZ9009	8U RTU Cabinet with 2A PSU (Requires TIC or RIC)
SZ9005	IOR RTU Cabinet with 2A PSU (Requires TIC or RIC)

Upgrade Kits

4100-7149K	19" 4100 to 4100ES U/G kit (new LCD & CPU card)
4100-KT0488	Legacy 4100 to 4100ES U/G kit (new LCD & CPU Card)
4100-7152K	4100 classic to 4100ES U/G kit for legacy cabinet (complete 4100ES Controller Bay
4100-7158K	4100U to 4100ES U/G kit (4100ES CPU)
742-516	4100U/ES CPU Motherboard 566-227
4100-SX0184	4100ESi InfoAlarm+ mounted on swing down door
4100-KT0568	4100-S1 panels replacement trim panel (new trim required to suit larger InfoAlarm+ display)

Options

4100-9256	2 unit expansion rack 15U200
4100-9257	4 unit expansion rack 28U310
4100-9258	6 unit expansion rack 40U310
4100-9259	8 unit expansion rack 40U310
4100-0401	8 red LED module
4100-0402	16 red/yellow LED
4100-0403	8/8 Mom. switch/red LEDs
4100-0404	8/16Maint. switch/red-grn LEDs
4100-0405	8/16 Mom. switch/red-yel LEDs
4100-0406	8 yel LED module
4100-0420	A/C reset switch module
4100-0450	4100 LCD in RTU
4100-5129	Ferrite Bead Kit - 3 beads & cable ties
4100-9826A	4100 AS4428 upgrade for AS1603 FIPs
4100-0410	PA microphone & keyswitch
4100-FP1046	8U Expansion Cab, Window, Titania, suits PDI cards only. 1x7U Display Door Fitted
4100-FP1086	8U Exp. Cabinet, blank door, Titania, PDI or Legacy cards
4100-FP1088	15U Expansion Cabinet, full window door, Titania, 15U Gear Plate, 2x 8 Slot Display Doors
4100-FP1087	15U Expansion Cabinet, blank door, Titania, with 10A PSU
KT0419	3U Self-Adhesive Document Holder
FA2166	Brand Label Domex, Simplex
FA2637	4100ESi Outer Door Applique
746-177	4100ESi Compact Flash Card

Network Interface

4100-6014AUK	Modular Network Card (use on 4100+ to 4100ES does not support NAC Synchronisation)
4100-6078	Modular Network Card (Latest NIC for 4100ES/ESI panels supports NAC Synchronisation)
4100-0142K	Wired Media Card RS485 (for older legacy 4100+ Version 3 or earlier network cards)
4100-6056	Wired media card suit 4100+ to ES. Use with 4100-6014 / 6078 network card
4100-6057	Fibre Optic Media Card suit 4100+ to ES. Use with 4100-6014 / 6078 network card
4100-6072	Fibre Optic Modem left port assembly
4100-6073	Fibre Optic Modem right port assembly
4100-6301/2	Duplex Single-Mode Fibre Media Card
4100-6303/4	Duplex Multi-Mode Fibre Left Media Card
4100-9840	Mounting brkt for 4100-6063/4 to mount in Legacy bay
4100-9863	TCP/IP Physical Bridge, Class B

This page is intentionally left blank.

Warranty Procedure

1. PURPOSE

To ensure prompt and consistent handling of warranty returns. The procedure assists in monitoring product quality and continuing to reduce the incidents of defective product.

2. POLICY

Johnson Controls offers a product warranty of 24 months from the date of purchase, for Johnson Controls manufactured product. Third party or buy-in items will attract a warranty period as per the manufacturer warranty conditions. Warranty returns will only be accepted for defective material or faulty workmanship. A full credit of the purchase price will be issued for authorised and verified returns of defective product.

Johnson Controls will not accept responsibility for consequential, liquidated damages, or third party costs caused as a result of faulty products.

Note: Certain products with shorter shelf life may be excluded from the 24 month warranty period. Refer to your Johnson Controls representatives for details.

3. PROCEDURE

Product returns - including Third Party Products, e.g. VESDA - will not be accepted unless an RAN (Return Authorisation Number) has been issued to authorise the return. All returned goods must clearly state the RAN on the external packaging.

An RAN can be obtained by telephoning Johnson Controls Customer Service on 1300 725 688.

When contacting Johnson Controls for an RAN, please have the following information available:

- Your contact details
- Location and site details of where the faulty product is installed
- Delivery docket or invoice number on which the product was supplied
- Item Name
- Product Code
- Description of fault sufficiently detailed to aid investigation by manufacturer
- Serial Number and date code (if applicable)
- Details of the likely nature and cause of the fault
- Purchase order number and delivery address for the replacement product

Once Johnson Controls approves the return, an RAN will be issued for the return of the product.

Customers are required to return the faulty product within one calendar month of the issuing of the RAN. Freight is to be paid by the customer. After one month the RAN will expire and the goods will not be accepted for credit.

4. PROCESSING WARRANTY CREDITS

Warranty returns will be credited to the customer only when the failure of the product has been verified by Johnson Controls.

It is anticipated that all credits will be finalised within two (2) weeks of product return - in the majority of cases a credit will be processed within one week of the product return. There may be occasions where finalisation will take longer if further technical evaluation or assessment by a third party is required, or other constraints delay processing.

NOTE: In cases where products have been returned under warranty, and after testing and verification, no fault is found, a credit will not be issued. After discussion with customer, the no fault found product/s maybe returned to the customer.

RAN PROCESS

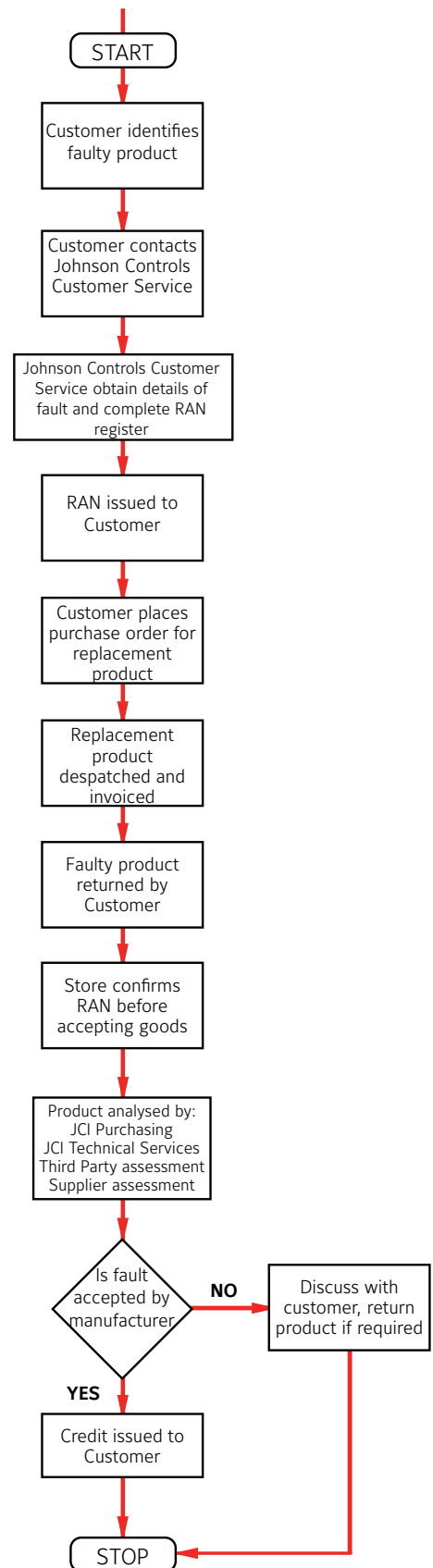

Fire Detection Product Catalogue

QE90 EWIS Panel Configuration Sheet – Please download the latest LT0613.xlsx

QE90 EWIS PANEL CONFIGURATION SHEET

CLIENT:
 AML R7 AR8
 NPMHAR8
 B? RC PC08

MPBCP L n8
 B? RC8
 JME MR WNC8
 QNCAG J A? @ C RAMUMS P
 A? @ CR F L E E P COS P CB

SECP
 (FP0539) PAGING CONSOLE
 (SUJ0168) GOOSENECK MIC.
 (SUJ0169) DESKTOP MIC.
 (PA0688) MIC. PRE-AMP BD
 Cabinets (Qty)

Bold columns are compulsory +Mrf cqqnmrgh j, P ccdprmn@...72@tmrpg qfrsairgh q

Evac Zone No	Ct_a Xnh c L_k c	Fireone	Loudspeaker Output &J_rrq			Amplifiers		Strobe Msmr rq &0nw O? Ncp Msmr	Wips &0nw '#1'	BGA Inputs	Fip Inputs	Pck_pi q
			/	0	3	JM? B	P? R L E					

Cascade

Bgl_jcb
 Q_l_b.pb 0 sn / bmu j
 Qicagj_r_r_af cb

Inputs

@? sqc DNGmq
 @? sqc I-2 u grc U GN aarq
 @? sqc O u grc U GN aarq
 DNG sq U GN aarq
 DNG sq P X B S
 DNG sq N J c J B I

Relay Outputs

X D_sjr
 ? J_pk
 ? I w? jcp-ct_a-NP -N? @
 Mrf cp_r_r_af cb

Speech Messages

Ct_a_ qibgrcarcb & sq
 Ct_as_rc Rpc cvg & X'
 Qicagj_r_r_af cb
 Qicaf g_s rmmh jw
 K cql ec u gf ? jcp rnh c

Evacuation tone

QM60. / & sqbcdsjr
 ? Q000. & X bcdsjr

Networking

? rr af_xnh c +xnh c_nng e*anh rprj
 ngrprw*grcp CAN U GN qra

Fire Detection Product Catalogue

Index

Stockcode	Product Description	Page	Stockcode	Product Description	Page	Stockcode	Product Description	Page
20-118	Sounder/Strobe, Red 24Vdc 3W	90	516.052.051	MD601Ex Conventional Heat EEx ia IIC T5	110	576.080.016	Solista LX Wall Beacon (Red Flash/Red Body) Deep base (IP65)	87
2081-9027	Isolated Loop Circuit Protector	57	516.054.011.Y	MR601TEx Conv. High Perf Opt Smk Det	110	576.080.017	Solista LX Ceiling Beacon (White Flash/White Body) Shallow base	87
2190-9162	Signal & Control ZAM Style Y Flush	57	516.061.001	MDU601Ex Enhanced CO & Heat	110	576.080.018	Solista LX Wall Beacon (White Flash/White Body) shallow base	87
2190-9173	2 Point I/O Module	56	516.600.066	601FEx Conventional Flame Detector	111	576.080.019	RoLP LX Wall Sounder Beacon (Red Flash/Red Body)	87
2975-9006	ZAM Box for 2 Pt I/O	60	516.600.301	VIGILANT 614P Photoelectric Col. Smk Det	7	576.080.020	RoLP Sounder (Red Body) Deep base(IP65)	87
4B-DHM	DeckHead Mounting	9	516.600.304	VIGILANT 614CH CO & Heat Col. Det	7	576.080.022	Solista LX Wall Beacon (Red Flash/White Body) Shallow base	87
40020	External Wall Mount Strobe Only	90	516.600.305	VIGILANT 614I Ionisation Conv. Smoke Det	7	576.080.023	Solista LX Ceiling Beacon (Red Flash/White Body) Shallow base	87
40020B	External Wall Mount Strobe incl. Back Box	90	516.800.006	MX Addressable 801F Flame Detector	17	576.080.024	RoLP LX Wall Sounder Beacon (Red Flash/White Body)	87
4090-9002	Relay IAM	47,58	516.800.066	MX Addressable I.S. 801FEx Flame Det.	109	576.080.025	RoLP Sounder (White Body) Shallow Base	87
4090-9007	Signal IAM	57,58	516.800.530	MX Addressable I.S. 801PHEX Photo/Heat	108	576.501.047	Beacon/Sounder Mounting Bracket	90
4090-9008	Dual Contact Relay IAM	58	516.800.531	MX Addressable I.S. 801CHEX CO/Heat	108	576.501.060	IP45 Multi-Tone Sounder	90
4090-9051	Encapsulated Supervised IAM	47,60	516.800.532	MX Addressable I.S. 801HEX Heat Det.	108	576.501.062	IP66 Multi-Tone Sounder	90
4090-9101	IDNet Monitor Zone Adapter Mod(ZAM)	58	516.800.915	Address Flags for 800 Series MX dets	19	576.501.224	Comb. Sounder/Strobe Shallow Base	90
4090-9116	IDNet Line Isolator	47,59	516.800.917	M600/M800 Dtctr Removal Tool	49,117,118	576.501.227	Comb. Sounder/Strobe Deep Base	90
4090-9117	IDNet Power Isolator	59	516.800.954	SAM800 MX Addressable Sounder Module 27		577.001.035	601SB Sounder Base	9,124
4090-9118	IDNet Relay IAM with T-Sense Input	59	516.800.956	SAB801 MX Addressable LED Beacon	27	577.800.006	DDM800 MX Universal Fire & Gas Det. Mod	25
4090-9119	IDNet Relay IAM with Unsupervised Input	59	516.850.051.E	850PH Gen6 MX Photoelectric/Heat Det.	16	592.001.005	T110 Adaptor For S131/161	118
4090-9120	IDNet 6-point I/O c/w T-Sense & Relay O/P	60	516.850.052.E	850P Gen6 MX Photoelectric Detector	16	592.001.010	T110/T210 PP9 Battery and Charger Kit	118
4090-9802	Cover Plate for IDNet Mounting Box	57,60	516.850.053.E	850H Gen6 MX Heat Detector	16	592.001.012	T110 Test Src SOLO704/100/101	109,111,118
4098-9637EA	614T Type A Heat Det	8	517.001.184	S100/200 Flame Det Mnt Brkt S/S	118	592.001.014	T210+ Adaptor for S200+ Detectors	118
4098-9638EA	614T Type B Heat Det	8	517.001.224	SOLO704 Adaptor Tube	117	592.001.016	T210+ Plus Test Source for S200+ only.	
4098-9639EA	614T Type C Heat Det	8	517.001.226	SOLO101 Extension Tube	117	592.001.018	Suitable For Use In Hazardous Areas	118
4098-9640EA	614T Type D Heat Det	8	517.001.230	SOLO101 Telescopic Pole	117	592.001.019	T110 Adapter for 601/801F Detect's	109,111
4098-9714EA	TrueAlarm Photoelectric Smk Dtctr	47,54,55	517.001.240	X200 SOLO200 Detector Changer	117	601SB	MkII Sounder Base	9,124
4098-9733EA	TrueAlarm Heat Detector	47,54	517.001.277	SOLO461 Heat Detector Tester Head Unit	117	733-794	4100 Download Port Cable 10W FRC-DB9	69
4098-9754EA	TrueAlarm Photo & Heat Multi Sensor	54	517.001.255	X330 SOLO330 Aerosol Dispenser	117,118	814RB	MX Addressable Relay Base	21
4098-9755EA	TrueAlarm DSU	55	517.001.259	Galvanic Current Repeater 1 Channel	109	850EMTK	MX Engineering Management Tool Kit	19
4098-9789EA	TrueAlarm Analogue Addressable Base	55	517.001.262	CO Test Gas 120g can	117,118	885WP-B	Type B Conventional Thermal Det. Potted	8
4098-9793EA	TrueAlarm IDNet Isolator Base	55	517.001.264	SOLO610 Carry Bag	117,118	A2339	Audio Line Attenuator 100V 100W	93
4098-9794EA	TrueAlarm Analogue Addr. Sounder Base	55	517.001.273	SOLO770 Spare Battery Baton	117	A2255	Audio Line Attenuator 100V 40W	93
4098-9795EA	TrueAlarm Multi-sensor Sounder Base	54	517.001.279	SOLO A10s Test Smoke 250ml can	117	A2260	Audio Line Attenuator 100V 10W	93
4098-9796EA	TrueAlarm Analogue Addr. Detector Base	54	517.035.007	M520 Cover Ancillary Cover	29,49	AAM2	Alarm Acknowledge Module FP0894/5	63
4098-9846	TrueAlarm Detector Wire Guard	61	517.035.010	K2142 PC/ABS Double Gang Back Box	29,49	ADM130-Mk2	130 series Monitor Module	43
4098-9856	Tube, Duct Sampling 1.2m	55	517.035.011	K2214 Aluminium Double Gang Back Box	29	ADM131-Mk2	130 series Mini Monitor Module	44
4099-9701	IDNet Manual Call Point	47,60	517.035.015	QFB/2 PC/ABS Double Gang Back Box	29	ADS130-Mk2	130 series Short Circuit Isolator	43
4099-9702	MAPNET II Manual Call Point	60	517.050.015	Volume Adjustment Tool	9	B200SR	130 Series Sounder Base	42
4100ES	Fire Alarm System	45-52	517.050.023	5BEx Universal Base for 600/800 Ex Det.	112	B501AUS	130 Series Detector Base	42
4100-0110K	Addressable Module	56	517.050.041	4B Universal Base	9,20	BELL01	Motorised Bell 200mm 24Vdc	94
4100-0154K	Simplex/VESDA HLI Panel Mount I/F	51	517.050.042	4B - C Continuity Base (MX1 only)	20	BELLO02	Bell Back Box	94
4100-1026K	Mini-Gen Mk2 24V 20W - Simplex	83	517.050.043	4B - I Isolator Base	21	C0612D	QE90 WIP Phone External Speaker	79
4100-1287AU	4-way 1668 Networked Fan Ctrl Module	47	517.050.051	4B-DHM DeckHead Mount	9,20	C2052	Horn Speaker Mount 'Wurli-Gig'	91
4100-3109AUK	IDNet2 Loop Card (2 loops)	48	517.050.056	Ceiling Tile Adaptor Back Box	9,20,21	CCU	CCUNet	75
4100-3110AUK	IDNet2+2 Loop Card (4 loops)	48	517.050.057	Ceiling Tile Adaptor Bezel and Clamp	9,21	CG0002-CLIENT	XLG-C/S Client/Server Software & Dongle	40
4100-5013	8 Zone / Relay Card	49	517.050.058	Ceiling Tile Adaptor Plate	9,21	CG0002-CS	XLG-C/S Client Only Software	40
4100-5129	Ferrite Bead Kit - 3 beads & cable ties	49	517.050.060	Ceiling Tile Adaptor Kit	9,21	CIM800	MX Addressable Contact Input Module	25
4100-6301/2	Duplex Single-Mode Fibre Media Card	49,52	517.050.612	Terminal Accessory Kit	9	CP820	MX Addressable Manual Call Point	18
4100-6303/4	Dplx Multi-Mode Fibre Left Media Crd	49,52	545.800.004	LIM800 MX Addressable Loop Isolator Mod.26	26	CP830	MX Addressable IP67 Manual Call Point	18
4100-6069	BACpac™ Ethernet Module	49,51	547.004.002	DIN Rail Mounting Bracket	29	CRC-TEST	Detector Test Smoke 71g	117
4100ESI	1668 Control Options	47	555.800.063	SIO800 MX Single Input/Output Module	28	D515B	Duct Housing c/w 5B base	8
4100-FP1045	4100ESi Compact 15U	46,49	555.800.070	QMO850 MX Quad Monitored O/P Module 27		D51COVER	D51 Cover	8
4100-ME0456	4100ESi 4x AS1668 Fan Control Module	47,49	555.800.071	QIO850 MX Quad Input/Output Module 27		D51L	D51 Baffle pkt of 10	8,17,42
4100-ME0470	4100 5A 24Vdc PSU	96	555.800.073	QRM850 MX Quad Relay Output Module 27		D51F	D51 Filter pkt of 10	8,17,42
4100-MXPK	4100MXP MX Responder on Bracket	49	555.800.065	MIO800 MX Addressable Multi-I/O Module 26		D51K100	D51 Sampling Tube End Cap pkt of 10	8,17,42
4190-9050	Analogue Monitor ZAM	57	557.001.040	MkII Sounder Base Terminal Cap	9,27	D51T3	D51 Sampling Tube 3m	8,17,42
4300	Fire Wire Enclosure	113	557.080.001	Blanking Cap Sounder/VAD Bases	22,23	D51	Duct Housing without base	8,17,42
4603-9101	Serial LCD Annunciator	49,50	557.080.002	Conduit Adaptor Sounder/VAD Bases	22,23	D51MX	MX Duct Housing	17
4906-9103	Wall Mount Multi-Candela Synch. Strobe	89	557.080.007	Shallow Surface Back Box For Wall Sounder / VAD Red	24	D51Z131	130 Series Duct Housing	42
4906-9104	Ceiling Mount Multi-Candela Synch.Strobe	89	557.080.008	Shallow Surface Back Box For Wall Sounder / VAD White	24	DD0084	QE90 FIP EOL Diode Zener 10V 1W 5%	82
514.001.062	IF800Ex I.S. Interface	109	557.080.010	Flush Back Box Adaptor For Indoor Wall Sounder / VAD	24	DIM800	MX Addressable Detector Input Module	25
514.001.063	EXI800 MX I.S. Loop Interface	109	557.080.010	MIO DIN-Rail Mounting Kit	29	DLE201215A	Strobe Amber - IP65	89
514.001.109	MCP220Ex Collective Call Point	111	557.080.010	D800 MX Module Ancillary Housing	29	DLE201215R	Strobe Red - IP65	89
514.800.513	CP840Ex MX Addressable Callpoint	109	557.201.303	MX Quad I/O Module IP66 Anc. Housing	27	E502	Remote Indicator 75mm dia Fire Alarm	62
515.001.025	MCP Glass no logo	10,18,60,79,98	557.201.401	80DSB Detector Sounder Base	23,49	E521	Rem. Ind. 75mm dia F A in Conc. Space	62
515.001.029	Weather Stopper Flush Mount	11	557.201.410	P80SB Addressable Base Sounder	23,49	E523	Rem. Ind. 75mm dia Fire Alarm in Room	62
515.001.030	Weather Stopper Surface Mount	11	576.080.001	P80SB MX Sndr Base (Loud) - loop wrd (AS7240 approved)	23	E524	Rem. Ind. 75mm dia Fire Alarm Above	62
515.001.033	Weather Stopper IP036 Break Seal Kit	11	576.080.002	P80AVB MX VAD Sndr/low Beacon Base (Loud/Fast Flash)	22	E525	Rem. Ind. 75mm dia Fire Alarm in Duct	62
515.001.034	Weather StopperII	11	576.080.002	P80AVW MX VAD Sndr/ Bcn Wall White (Loud / Fast Flash)	24	E526	Rem. Ind. 75mm dia Fire Alarm in Roof	62
515.001.035	Weather StopperIII Surface Mount	11	576.080.002	P80AVR MX VAD Sndr/ Bcn Wall Red (Loud / Fast Flash)	24	E529	Rem. Ind. 75mm dia Fire Alarm in Cupboard	62
515.001.036	Surface Mount Weather Cover	11	576.080.006	P81AVB MX VAD Sndr/High Beacon Base (Loud / Fast Flash)	22	E542	Rem. Ind. Rect. Fire Alarm	62
515.001.043	Breakglass Keyboard	10	576.080.007			E551	Rem. Ind. Rect. F A in Concealed Space	62
515.001.127	Manual Call Point Plastic Insert Element	10	576.080.007			E553	Rem. Ind. Rectangular Fire Alarm in Room	62
516.016.301	ICAM Air Sampling Detector	105	576.080.008					
516.016.303	ICAM Course Filter (Pkt10)	105	576.080.014					
516.016.304	ICAM IAS801 1 Pipe Air Sampling Det.	105						
516.016.305	ICAM IAS802 2 Pipe Air Sampling Det.	105						
516.018.014K	VIO800 VESDA Interface Mod c/w brkt	28,49						
516.041.003	S271f+ MX Flameproof	107						
516.041.004	S271i+ MX Intrinsically Safe	107						
516.052.041	MD611Ex Conventional Heat EEx ia IIC T5	110						

Fire Detection Product Catalogue

Index

Stockcode	Product Description	Page	Stockcode	Product Description	Page	Stockcode	Product Description	Page
E554	Rem. Ind. Rectangular Fire Detector Above	62	FA1235	Flush Surround for 15U Cabinet	65	FP0871	MX4428 Single Loop Panel incl. ASE brkt	14
E555	Rem. Ind. Rectangular Fire Alarm in Duct	62	FA1267	F3200 Gear Plate Standard 480x460	65	FP0872	MX4428 Single Loop Panel incl. Cube brkt	14
E556	Rem. Ind. Rectangular Fire Alarm in Roof	62	FA1299	Flush Surround for 8U Cabinet	65	FP0876	F3200 AS4428 8U, 3A PSU 1U Gas Ctrl	6
E561	Rem. Ind. Rect. latch.F A in Conc. Space	62,112	FA1366	F4k Gear Plate Large Sideless 1200x483	65	FP0877	F3200 AS4428 15U, 6A PSU 1U Gas Ctrl	6
E566	Rem. Ind. Rect. latch.F A in Roof Space	62,112	FA1833	QE90 Gear Plate suit ≥28U cabinet	65	FP0880	Nurse Station Annunciator Flush Mnt	74
E573	Rem. Ind. Rect. latch Fire Alarm in Room	62,112	FA1846	QE90 Gear Plate suit ≥18U cabinet	65	FP0881	Nurse Station Annunciator Surface Mnt	74
E574	Rem. Ind. Rect. latch Fire Alarm Above	62,112	FA1852	QE90 6U Smoked Perspex Panel	65	FP0882K	PSU F4000 AS1603 24Vdc 5A	97
E575	Rem. Ind. Rect. latch Fire Alarm in Duct	62,112	FA1922	QE90 Paging Console Keypad	78	FP0894	AAM2 with FA2317 Fascia	63
E700-CSC	Capillary Sampling Connector	106	FA1983	F4k Gear Plate 18U Sideless 770x483	65	FP0895	AAM2 with FA2318 Fascia	63
E700-CT	Capillary Sampling Tube 8mm OD	106	FA1929	Flush Surround for 18U Cabinet	65	FP0898	MX Loop Tester	19
E700-EC	End Cap - not drilled	106	FA1930	Flush Surround for 28U Cabinet	65	FP0902	PC Paging Console	78
E700-FMK-2	Filter for VESDA Mk2 System	104	FA1931	Flush Surround for 40U Cabinet	65	FP0927	MX1 15U 3U ASE bracket	12
E700-HASP	Heat Activated Sampling Point	106	FA1984	F4k Gear Plate 18U Sided 770x482x180	65	FP0928	MX1 15U 3U WA/Cube ASE bracket	12
E700-J	J - Fitting, 2 Branch Adaptor	106	FA2017	QE90 5.5U Blanking Plate	14,65	FP0935	4100ES-S1 ASE Door Kit	47,65
E700-LB	Long Radius Bend 150mm	106	FA2019	QE90 Bracket SECP Battery	65	FP0937	4100ES-S1 WA/Cube ASE Door kit	47,65
E700-P	VESDA Bell End Pipe 4m x 10 lengths	106	FA2027	Keypad Only, ECP+2Z Keyboard,3 W/Z	81	FP0938	WIP Phone	79
E700-PC	Pipe Clip - Single Point Fix	106	FA2029	Keypad Only, 8Z Extender Keyboard,3 W/Z	81	FP0948	MX1 15U 3U Blank	12
E700-PJ	Pipe Junction Fitting	106	FA2031	Flush Surround for 21U Cabinet	65	FP0950	MX1 Loop Card Kit	12
E700-SP	Small Radius Bend 90mm	106	FA2040	F4k Gear Plate Basic 15U 540x460	65	FP0986	PIB Panel-Link Internet Protocol Bridge	36
E700-SB	Sampling Point - Mini	104,106	FA2113	40U Outer Door Full Window	65	FP0991	MX1 Remote Fire Brigade Panel	12
E700-SPDCL	Sampling Point Decal 200 per roll	104,106	FA2150	AS4428 4U Membrane Overlay	125	FP0996	MX1 4U Remote Fire Brigade Panel	12
E700-SPLR	VESDA LBL Sampling Point Label	104,106	FA2317	AAM2 Cover 'Press to ACK Fire Alarm'	63	FP1002	MX1 16Z LED Display Extender	12,64
E700-SRB	Standard Base for HASP	106	FA2318	AAM2 Cover 'Press to ACK Alarm Cancel'	63	FP1027	MX1 Loop Card/MX Module Mtng Bracket	29
E700-T	Solid Tee	106	FA2776	AVI Face 'D N E FM200 Discharged'	95	FP1030	MX1 15U Empty Wndw Cab, no MCP, Titania	12,65
E700-TA	Trunk Adaptor	106	FA2700	AVI Faceplate 'Fire Alarm Evac Area'	95	FP1032	OSD139 Fibre Optic Modem x2 Mtng Kit	34,37
EA0005	OneShot 5W, 100mm Spkr/grille incl. cap.	92	FA2701	AVI Faceplt 'Fire Alarm Do Not Enter'	95	FP1037	AVI-Mk2 IP65 24V 2-Line Red no Fascia	95
EA0006	100mm Speaker incl tx & cap.	92	FA2702	AVI Face 'Do Not Enter CO2 Dischgd'	95	FP1038	AVI-Mk2 IP65 24V 3-Line Yel no Fascia	95
EA0007	200mm Speaker incl tx & cap.	92	FA2703	AVI Face 'D N E FM200 Discharged'	95	FP1040	MX1 8U Panel Aust 3U Blank Fitted	12
EA0008	200mm Speaker Surf. Mnt. incl tx & cap.	92	FA2704	AVI Face 'D N E Inergen Discharged'	95	FP1056	MX1 3U 12-Way AS1668 Ctrl Door 2Ctrl	12,72
EA0013	ABS 10W Horn Spkr + cap. 255mm	91	FA2710	AVI Face 'Warning Fire Door Closing'	95	FP1057	MX1 2-Way AS1668 Ctrl Bd Extnsn Kit	12,72
EA0016	ABS 20W Horn Spkr + cap. 285mm	91	FP0101	Electromagnetic Door Holder	98	FP1062	MX1 4xModule Bracket	29
EA0017	Alum 30W Horn Spkr 270mm	91	FP0475	F4000 Display Ext. Kit 1901-26	5,14,64	FP1063	MX1 4xDDM800 Bracket	29
EA0020	8 Ohm 10W ABS Horn Speaker	91,95	FP0487	Loop Booster Unit	14, 32	FP1083	QE90 8Z Display Ext. 3W/Z inc PCB	81,82
EA0025	OneShot Spkr 5W 100mm AS7240.24	92	FP0507-5	EOL002B Pulsing EOL (pkt 5)	14,30	FP1084	MX1 15U Empty Cab, Titania	65,72
EA0027	OneShot Horn Spkr 10W AS7240.24 Wht	92	FP0529	Empty ADR/MPPR box	14,29	FP1092	6U NT Brigade Door Kit Vigilant grey	65
EA0028	OneShot Horn Spkr 10W AS7240.24 Blk	92	FP0539	Paging Console	78	FP1093	6U NT Brigade Door Kit Simplex black	65
EA0029	Surf Mnt Spkr 5W AS 7240.24 - White	93	FP0545	Printer Option Kit 1901-112	14	FP1135	Isolation Amplifier T-Gen2 60W	85,94
EA0030	Surf Mnt Spkr 5W AS 7240.24 - Black	93	FP0546	Printer DPU411	14	FP1138	MX Addressable Local Gas Control Station	73
EA0031	Surf Mnt Spkr 5W 200mm AS7240.24-Wht	93	FP0553	F3200 8 Zone Expansion Kit	5,6	FP1143	T-Gen2 High Level Interface Module	85,86
EA0032	Surf Mnt Spkr 5W 200mm AS7240.24-Blk	93	FP0554	F3200 8 Relay Expansion Kit	5,6	FW105	105°C Sensor Cable	113
EA0031	Surf Mnt Spkr 5W AS 7240.24 - White	93	FP0556	F3200 15U Empty Cabinet Full Window	65	FW180	180°C Sensor Cable	113
EA0032	Surf Mnt Spkr 5W AS 7240.24 - Black	93	FP0557	F3200 15U Empty Cabinet Blank Door	65	FW68	68°C Sensor Cable	113
EA0033	Surf Mnt Spkr 15W 200mm AS7240.24-Wht	93	FP0570	Local Gas Control Station - Auto	73	FZ3031	16 Zone LED Display PCB (LHS)	5,14,64
EA0036	OneShot Spkr 5W 100mm AS7240.24-Wht	93	FP0572	Local Gas Control Station - Manual	73	FZ9002	7U Blank Hinged Inner Door	5,14,65
EA0037	OneShot Spkr 5W 100mm AS7240.24-Blk	93	FP0575	F4000 MPR 1901-141	14,30	FZ9003	6U Blank Panel Acrylic	5,14,65
EA0101	Grille for EA0007	92	FP0576	PSU/Battery Box 440x550x211mm	65	FZ9004	4U Blank Panel	5,14,65
EA0102	Grille for EA0006	92	FP0584	F3200 8U Empty Cabinet Full Window	65	FZ9005	3U Blank Panel	5,14,65
EA0104	Screw Covers Pkt of 80	92	FP0586	Protocol Translation Module 1942-1	14,36	FZ9006	2U Blank Panel	5,14,65
EA0301	Strobe Amber Ax35	89	FP0749	F3200 PSU Upgrade Kit 3A to 6A AS1603	5,6	FZ9007	1U Blank Panel	5,14,65
EA0302	Strobe Red Ax35	89	FP0755	F4000 ADR-M 4mA 1901-116	14,30	FZ9011	7U Door 5 AS1668 Fan Controls	72
EA0305	Strobe Amber TK86HP24	89	FP0766	PSU1948 24V 2A	94,97	FZ9012	7U Door 15 AS1668 Fan Controls	72
EA0306	Strobe Red TK86HP24	89	FP0770	MX4428/F3200 NDU to Ring Netwk Kit	34,37	FZ9015	5U Blank Panel	5,14,65
EA0313	Dual Strobe Unit	90	FP0771	I-HUB Networking Kit	14,34,37	FZ9016	6U Blank Panel	5,14,65
EA0345	Round wht Tag Plate (Fire/Evacuate)	88	FP0779	F3200 PSU Upgrade Kit 3A to 6A AS4428	5,6	FZ9028	3U WA/Cube ASE Bracket & Loom	5,14,49,65
EA0346	Rectangular wht Tag Plate (Fire) 15mm	88	FP0780	F3200 24 Zone, 3A PSU, No Cardframe,15U	5	FZ9036	2U Door 5 AS1668 Fan Controls	72
EA0347	Rectangular wht Tag Plate (Evac) 15mm	88	FP0781	F3200 64 Zone, 3A PSU, incl. Cardframe,15U5	5	FZ9037	7U Blank Panel with Front Doc. Holder	65
EA0348	Rectangular red Tag Plate (Fire) 15mm	88	FP0782	F3200 24 Zone, 6A PSU, No Cardframe,15U	5	GX93R	Mini Horn Sounder ISO 8201 T3 Red	94
EA0349	Rectangular red Tag Plate (Evac) 15mm	88	FP0783	F3200 64 Zone, 6A PSU, incl Cardframe,15U	5	GX93W	Mini Horn Sounder ISO 8201 T3 White	94
EA0350	Rectangular red Tag Plate (Fire) 50mm	88	FP0784	F3200 8 Zone, 3A PSU, 8U	5	HP-20EEXIIN(T)	20W Ex Horn Speaker	91
EA0405	Magnetic Door Holder Release Switch	98	FP0787	RDU Slimline Wall Mount	74	HW0040	Lock A/CR16/01/3B/N04 003 Key	65
EA0407	Electro-magnetic Door Holder 150mm	98	FP0788	RDU Slimline Flush Mount	74	HW0202	Block, Hinge Set 6mm	65
EA0408	Electro-magnetic Door Holder 300mm	99	FP0789	RDU 4U 19" Rack	74	HW0226	Key only 003 style	65
EA0409	Floor Mount Door Holder & Box	99	FP0790	NDU 15U MAF, PSU	74	IC0320	F4k IC 28C64 8k EPROM	125
EA0410	Electro-mag Door Hold 150mm,90deg	99	FP0791	NDU Slimline Surface Mount	74	IC0414	F4k IC 28C010 128k EEPROM (U2 PA0482)	125
EA0411	Electro-mag Door Hold 300mm,90deg	99	FP0792	NDU Slimline Flush Mount	74	K2142	Back Box for MX modules	29
EA0412	WIP Phone Surface Mount Enclosure	79	FP0793	NDU Slimline Deep c/w I-HUB	74	KFD0-Ex151	Galvanic Current Repeater 1 Channel	113
EA0413	Electro-mag Door Hold 450mm,90deg	99	FP0794	NDU 4U 19" Rack	74	KFD0-Ex251	Galvanic Current Repeater 2 Channel	113
EA0414	Electro-mag Door Hold 385mm	99	FP0795	F3200 Network Upgrade Kit (AS 4428)	5	KFD2-STC4-Ex1	Galvanic Current Repeater 1 Ch SMART	113
ESS7010ISA	EExia LED Warning Light - Amber	90	FP0804	24V 0.5A PSU	94,97	KT0072	F3200 Cardframe Upgrade Kit	5,6
ESS7010ISR	EExia LED Warning Light - Red	90	FP0821	MX4428 master, LCD, 5A, 15U, no LEDs	14	KT0113	Kit, AS1668 Control Module Type 3	72
ESS7010R	Xenon Strobe	89	FP0824	MXP Responder in box	14,30	KT0144	Kit, PMB RS485 Module	34,35,37
ESS7111XR	IP Rated Flashing Beacon	90	FP0827	Standard Network Kit	14	KT0178	F4000 Point Text Upgrade Kit	125
F3200	Conventional Intelligent FIP	5	FP0837	MIM801	26	KT0199	3U ASE Bracket	5,14,65
F3200 8Z	F3200 8 Zone FIP	5	FP0842	Alarm Acknowledge Module AAM4	63	KT0274	Kit,F3200 AS 1603 to AS 4428 Upgrade	5,125
FA1185	F4000 Gear Plate Standard	65,67	FP0852	24V 2A VESDA PSU	97	KT0292	AVI Expansion Kit Red LED PCB+hardware	95
FA1199	F4k Gear Plate Large Sided 1200x483x180	65	FP0853	AVI MkII 2 Line Red	95	KT0293	AVI Expansion Kit Red Double Sided	95
FA1218	F3200 15U Outer Door Perspex	65	FP0854	AVI MkII 3 Line Yellow	95	KTO419	3U Self-Adhesive A4 Document Holder	14,65
FA1227	Blanking Plate 9.5U 1931-24	65	FP0865	Compact FF Surface Mount	74	KTO478	AS1668 5-Way Fan Control Module Kit	72
FA1228	F3200 15U Outer Door Blank	65	FP0866	Compact FF Flush Mount	74	KTO512	AS1668 4-Way Fan Control + Com.Master	72

Fire Detection Product Catalogue

Index

Stockcode	Product Description	Page	Stockcode	Product Description	Page	Stockcode	Product Description	Page
KT0519	QE90 AMP200 Kit incl. 2xPCB, 1x Loom	80	ME0444	4U Door & AS4428 Keypad (no PCB)	125	PA0799	PCB PTM no software 1931-84-3	36,125
KT0546	PSU2412 Additional Circuit Breaker Kit	96	ME0457	4U Door 5 x Zone Disp.(door only)	5,12,14,64	PA0804	PCB F3200 AS1603 Ctrl no s/w	36,125
LIM800	MX Line Isolator Module	26,29	ME0476	MX4428 24Vdc 5A PSU	97	PA0815	ADR-M 4mA 15V MCP 1901-116	14,30
LM0041	Programming Cable DB9 to CIE	14,69	ME0512K	4100ESI Cube ASE & Mic kit	49,65	PA0838	ZAU401 Zone Adaptor Unit	61,112
LM0042	Programming Cable DB25 to CIE	69	ME0513K	4100ESI Centaur11 ASE & Mic kit	49,65	PA0839	PCB Panel-Link I-HUB ECM9603	34,37
LM0047	QE90 TRAN8872 26W FRC Style D	69	MIM800	MX Addressable Mini Input Module	26,49	PA0868	PCB CMOS/TTL RS232 I/F 1931-110	34,37
LM0049	26W FRC Style B 0.25m	64,69	MIM801	MX Addressable Mini Input Module (N/C)	26	PA0873	F3200 MAF/PSU 3A - AS 4428	6
LM0053	20W FRC Style A 0.3m F3k 8 Rly to 8Z	69	MIO800	MX Multi Input/Output Module	26	PA0874	F3200 MAF/PSU 6A - AS 4428	6
LM0056	20W FRC Style B 1.4m	31-33,64	MR601TE	Conv. Optical Smoke Detector ATEX app	110	PA0878	PCB CMOS/TTL Signal Splitter	34,37
LM0065	RS485 DB9 to 10W FRC	34,69	MX1	Analogue Addressable FIP	12	PA0880	PCB DB25 to 10-way FRC Adaptor	37
LM0073	20W FRC Keybd to Main bd 1.45m	71,125	MX4428	Analogue Addressable FIP	14	PA0890	F4000 PCB AS4428 keypad/LCD module	125
LM0076	ECM Programming DB9F-DB9F 12,34,37,69,74		MX4428SL	Analogue Addressable FIP 1 Zone	14	PA0891	F4000 PCB AS1603 keypad/LCD module	125
LM0083	20W FRC Keybd to Main bd 0.7m	71,125	NT0030	Nut Cage M6 ZP	65	PA0893	MX4428 MXP Responder PCB only	14,30
LM0084	10W FRC Style B 0.35m	34	OSD139HS	Fibre optic HS Multimode RS232 Mod.	34,37	PA0909	PCB F3200 4428 Ctrl no s/w 1931-111-1	125
LM0091	10W FRC Style C 0.5m	34,71,125	OSD139HSL	Fibre optic HS Single mode RS232 Mod.	34,37	PA0915	PCB Fused Power Distribution	63
LM0092	F3200 Mk2 Controller to 1st Display	5,64,69	OSE-SP	OSID Emitter (std power, Battery)	114	PA0916	QE90 WIP Trmtn WTRM2000 PCB	81,82
LM0118	26W FRC Style B 0.6m F3k MAF to Cntrl	71	OSE-SPW	OSID Emitter (std power 24V)	114	PA0951	PCB MX4428 Main Bd no s/w 1901-12	125
LM0141	4W QE90 AMP200 Interconnect Loom	71,80	OSE-HPW	OSID Emitter (high power 24V)	114	PA1026	Mini-Gen Mk2 24V	83
LM0151	10W FRC-12W Molex MX4428 RingNet	71,34	OSD-RBA	OSID Emitter Replacement Battery Pack	114	PA1038	MXP Loop Filter PCB	18
LM0152	10W FRC ECM/F3200 Net X-Over 0.7m	34,71	OSI-10	OSID Imager 7 deg)	114	PA1040S	MX4428 Mainboard incl. Mem-LCD I/F	125
LM0160	10W FRC Style C 1.0m	34	OSI-90	OSID Imager (90deg)	114	PA1043	ISO 8201 Strobe Driver Module PCB	89
LM0185	MX4428 Molex to CMOS/RS-232	69,71	OSI-LS	OSID Light Shield	114	PA1081	MX1 Controller Board	120
LM0195	MAPNET Power Harness	69,71	OSID-EHE	OSID Emitter Environmental Housing	114	PA1144	QE90 WIP Slave OV ref WIPS2017 PCB	81,82
LM0291	26WFRC Styl B 0.23m MX1 Disp Intc.5,12,14,64		OSID-EHI	OSID Imager Environmental Housing	114	PS12120	Battery 12V 12Ah	96
LM0295	26W FRC Style B 0.7m	64,71	OSID-INST	OSID Install Kit (align't. tool, PC cbl, etc.)	114	PS12180	Battery 12V 18Ah	96
LM0339	26W FRC 0.2m Keybd-1st Disp	5,12,14,64,69	P131A-Mk2	130 Series Photoelectric smoke detector	41	PS12260	Battery 12V 26Ah	96
LM0572	Loom, I-HUB - OSD139 Mdm 1901-303	34,37	PA0449	F4000 Power Supply PCB 1901-2	125	PS12400	Battery 12V 40Ah	96
LPS800	MX Loop Powered Sounder Module	29,123	PA0453	Relay Responder Module 1901-15	14,30	PS12650	Battery 12V 65Ah	96
MD601EX	Conventional I.S. Heat Detector	110	PA0454	16-Zone Display Board	64	PS1270	Battery 12V 7Ah	96
MD611EX	Conventional I.S. Fixed Temp Heat Det.	110	PA0463	F4000 Loop Booster PCB 1901-35	32,125	QE90	EWIS Controller	77,96,126,130
MDU601EX	Conventional I.S. CO & Heat Det.	110	PA0470	16-Way Relay PCB	32,33	RACO232	Steel Box for IDNet Devices	57
ME0060	7U LED Display Door	64	PA0473	IOR PCB 32 in/32 out 1901-72	14,31	RIM800	MX Addressable Relay Input Module	27
ME0088	IOR Empty Cabinet 449x494x82mm	31,65	PA0474	32-Way Input Termination PCB	31-33	S271f+	MX Addressable Triple IR Flame Det Exd	107
ME0098	4U F3200 AS4428 Door & Cntrl PCB	5,125	PA0475	IO-NET 32 Way Input PCB	31-33	S271i+	MX Addressable Triple IR Flame Det Ex ia	107
ME0200	QE90 Cardframe incl. BPLN2000	126	PA0481	RZDU to RS232 I/F PCB 1901-100	32,33,81	SAB801	MX Sounder Addressable LED Beacon	27
ME0207	QE90 ECP Panel 3W/Z incl. PCB	81,82	PA0482	F4000 Memory/LCD I/F PCB 1901-102	125	SAM800	MX Sounder Addressable Module	27
ME0213	Mic.Dynamic, QE90 ECP9002 - DIN plug	78	PA0483	IOR Unprotected Terminal PCB	31-32	SC0058	Screw, M6x12 Pan Poz ZP	65
ME0250	Cabinet Empty IP66 20U x 200	65,66	PA0484	QE90 Paging Console PCB 1929-1	126	SC070	MCP Test Keys pack of 10	10
ME0251	Cabinet Empty 21U x 310 Window	65	PA0487	Banked EPROM Emulator PCB 1901-113	125	SF0202	Software Panel-Link I-HUB V1.14 EPROM	34
ME0252	Cabinet Empty 18U x 135 Window	65	PA0491	F3200 MAF/PSU 3A	125	SF0238	MPR Software V3.01	30
ME0253	Cabinet Empty 18U x 310 Window	65	PA0494	Bell Monitor Board	94	SF0239	Software IO-NET Controller V2.01	32,33
ME0254	Cabinet Empty 28U x 135 Window	65	PA0498	IO-NET 16-Way Output PCB	32	SF0261	Software F4000 Master V2.39N	125
ME0255	Cabinet Empty 28U x 310 Window	65	PA0642	QE90 WIP Slave OV ref WIPS2000 PCB	126	SF0349	MX4428 Master Software V3.21N	125
ME0256	Cabinet Empty 40U x 135 Window	65	PA0643	QE90 ECP7902-2 3WIP/Z PCB	81,82	SIM-Mk2-V	Speaker Isolation Module	94
ME0257	Cabinet Empty 40U x 310 Window	65	PA0644	QE90 VIF0907 VoIP I/F PCB	81	SJM0031	FA1201 F4000 LCD/Keyboard Overlay	125
ME0258	1U Document Tray (135 deep)	14,65	PA0646	QE90 Audio Line Isol ALIM9706 PCB	81,82	SJM0032	FA1159 F4000 Master Keyboard Overlay	125
ME0259	1U Document Tray (310 deep)	14,65	PA0647	QE90 200W Amp Module AMP200	80,81	SMB-500	130 Series Module Surface Mnt Box	44
ME0260	Cabinet Empty IP65 20U x 310 304 S/S	65,66	PA0648	QE90 200W Trnsfmr TRAN200 PCB	80,81	SNM800	MX Address. Sounder Notification Module	28
ME0261	Cabinet Empty 21U x 310 Blank Door	65	PA0649	QE90 SEC panel I/F SPIF9709 PCB	81	SR3T-P	MCP Back Box incl. Terminals	10,60
ME0262	Cabinet Empty 18U x 135 Blank Door	65,66	PA0650	QE90 4 Zone Pwr Amp EAMP9001 PCB	80,81	STI-13120FR	Weather Stopper Surface Mnt w/ Sounder	11
ME0263	Cabinet Empty 18U x 310 Blank Door	65,66	PA0651	QE90 FIP/BGA Master FIB8910 PCB	82	STI-8200-SS	Flush Mount Smoke Detector Guard	61
ME0264	Cabinet Empty 28U x 135 Blank Door	65,66	PA0652	QE90 FIP/BGA Ext FIP9004 PCB	82	STI-8230-SS	Surface Mount Smoke Detector Guard	61
ME0265	Cabinet Empty 28U x 310 Blank Door	65,66	PA0653	QE90 Disp/Keybd 3WIP/Z EMSP8911-2	81,82	STI-CIS	Speech Intell. Analyser & TALKBox kit	79
ME0266	Cabinet Empty 40U x 135 Blank Door	65,66	PA0657	QE90 Signal I/F SE9004 PCB	81	SU0168	Gooseneck Microphone	78
ME0267	Cabinet Empty 40U x 310 Blank Door	65,66	PA0660	QE90 Backplane BPLN2000	81	SU0169	Desktop Microphone	78
ME0268	Cabinet Empty 21U x 310 Window	65,66	PA0688	QE90 Mic. Preamp. 1923-19 PCB	80,130	SU0175	Single Paper Roll for FP0546 Printer	14
ME0269	Cabinet Empty 21U x 310 Blank Door	65,66	PA0689	QE90 WIP Flashing LED WLED9307 PCB	126	SU0605	MCP Glass - Wormald	10
ME0270	Cabinet Empty IP65 30U x 310	65,66	PA0690	QE90 2x50W Amp HAMP9308 PCB	80,81	SU0608	MCP White	79
ME0273	Cabinet Door 21U Outer Full Window	65	PA0691	QE90 2x50W Txfrmr HTRN9308-1 PCB	80,81	SU0613	MCP White Door Release S/P C/O	98
ME0274	Cabinet Door 28U Outer Full Window	65	PA0692	QE90 1x100W Txfrmr HTRN9308-1 PCB	80,81	SU0614	MCP White Door Release D/P C/O	98
ME0276S	Cabinet Door 40U Outer Full Window	65	PA0695	QE90 2x50W Msc Txfrmr HTMS9408-2	80,81	SU0615	MCP Transparent Hinged Cover	10
ME0280	Cabinet Empty IP65 40U x 310	65	PA0696	QE90 1x100W Msc Txfrmr HTMS9408-2	80	SU0631	MCP Collective Red new style no backbox	10
ME0286	Cabinet Door 40U Outer Blank	65	PA0697	QE90 Strobe/Relay STRM9502 PCB	82,89	SU0632	MCP Surface Mounting Box - red	10,18
ME0290	Dyn. Mic. for T-GEN50/QE90/ECP9702	78,85,86	PA0698	QE90 Comm Module ECM9603 PCB	83	SU0634	MCP Waterproof single pole changeover	10
ME0292	T-GEN 50 Empty Box Keyed 003	85	PA0700	IO-NET Programmer PCB	32,33	SW0018	QE90/TGEN A/I/E 3 dpst Keyswitch	65
ME0297	QE90/TGEN 50 A/I/E Sw incl loom & con	126	PA0711	RS485 Comms PCB Plug-on 1901-139-1	34,125	SW0121	PSU Mains Switch DPST 250VAC 6A	125
ME0330	PSU2406 24V 6A Brick for QE90	96	PA0712	RS485 Comms to RS232 PCB	34	SW0122	Switch Toggle LGCS	73
ME0331	PSU2406 24V 6A 2U mounting	96	PA0713	MPR PCB 1901-141	14, 30	SW0142	Switch Circuit Breaker DC 50A 65V	96
ME0333	PSU2412 24V 12A 2U mount for QE90	96,126	PA0730	PCB General Purpose Relay 24V	64	T131A-Mk2	130 series Heat Detector	41
ME0336	Cabinet Door 15U Outer Full Window	65	PA0758	QE90 Mux. 16s EMUX9601 PCB	81,83	T4E100X	T54B Point Type Heat Detector - 100°C	112
ME0340	PSU2406 24V 6A 2U mounting F4000	96	PA0759	QE90 Mux. 60s EMUX9601 PCB	81	T4E145X	T54B Point Type Heat Detector - 145°C	112
ME0341	Cabinet Empty IP65 20U x 310	65,66	PA0769	16W Unprotected Term Bd c/w rsistrs	31-33	T4E60X	T54B Point Type Heat Detector - 60°C	112
ME0343	PSU2412F 24V 12A 2U mount F4000	96	PA0773	RS485 Comms PCB FRC 1901-139-3	5,14,34,36,37,71,74,125	T4E90X	T54B Point Type Heat Detector - 90°C	112
ME0355	4U Door, AS4428 keypad, PA0890 PCB	125	PA0790	16-Way Clean Contact Input Board	35	TALKBOX	Talkbox for Speech Intelligibility Analyser	79
ME0420	AAM2 Alarm Acknowledge Module	63	PA0792	QE90 4x25W TRAN9705-2 PCB	81	TSIT-ALEADS	TrueSTART II Test Tool Repl/mnt Leads	56
ME0439	2 Zone Gas Flood 7U Door & Loom	73	PA0794	QE90 2x25W TRAN9705-4 PCB	81	TSIT-AUK	TrueSTART II Test Tool Kit	56
ME0440	3 Zone Gas Flood 7U Door & Loom	73	PA0795	QE90 4x10W Amp TRAN9706-1 PCB	81	VH-100	Hand Held Programmer Plus Leads	104
ME0441	4 Zone Gas Flood 7U Door & Loom	73	PA0796	QE90 4x10W Amp TRAN9706-2 PCB	81	VHX-0200	PC Link HLI Plus Leads (Mk2)	104
ME0442	1 Zone Gas Flood 1U Door & Loom	73				VHX-0310	VESDA HLI Open Protocol	104

Fire Detection Product Catalogue

Index

Stockcode	Product Description	Page	Stockcode	Product Description	Page	Stockcode	Product Description	Page
VHX-0400	Simplex PC Link HLI Plus Leads	51,104	VSP-005	Filter Cartridge (Spare)	104	VSW-005	VConfigPro software	104
VIC-010	LaserFOCUS VESDANet I/F card	100	VSP-006	Spare Detector Chassis + Manifold	104	W500	120 dia x 80mm detector cage	61
VIC-020	LaserFOCUS Relay Expansion Board	100	VSP-006ETN	LaserPLUS Chassis Equal-To-New	104	W502	195 dia x 120mm detector cage	61
VIO800	VESDA MX Interface Module	28	VSP-008	Spare Remote Termination card 7 relays	104	W504	130 dia x 105mm detector cage	61
VLC-500	LaserCOMPACT	100	VSP-009	LaserSCANNER Chassis + Manifold	104	W508	82 dia x 110mm T54B detector cage	61
VLC-500D	LaserCOMPACT Duct Detector	100	VSP-009ETN	LaserSCANNER Chassis Equal-To-New	104	WA0008	Washer Flat M6 12mm ODx1.2mm Thk	65
VLC-500ETN	LaserCOMPACT Equivalent-to-new	104	VSP-014	Spare Header Termination card 7 relays	104	X461	SOLO Heat Detector Tester	117
VLC-505	VESDA LsrCOMPACT+VESDANet I/F	100,104	VSP-015	Spare Aspirator Fan	104	X61	Brandax VS Smoke Emitter 60g	117
VLC-505D	LaserCOMPACT+VESDANet I/F Duct det.	100	VSP-018	Filter Switch Assy for VLP/VLS detector	104	X62	Ventilax Smoke Emitter 18g	117
VLC-505ETN	LsrCMPT+VESDANet I/F Equiv-to-new	100,104	VSP-019	LaserPLUS Filter Cover Door (Spare)	104	X65-25	Splintex Smoke Matches	117
VLC-800MX	MX LaserCOMPACT	17,100	VSP-025	Filter Cartridge VSP-005 pkt of 20	104	X66	Miniax Smoke Cartridge 3g	117
VLC505-ETN	LaserCOMPACT+R/O Equivalent-to-new	104	VSP-509	Cable, Serial DB9 M/F for VHX-0200	104	X811	Smoke Detector Tester Kit	117
VLF-250-02	LaserFOCUS	100	VSP-510	LaserCOMPACT Termination Card (RO)	100	X822	Smoke & Heat Detector test kit	117
VLF-250-02ETN	LaserFOCUS Equivalent-to-new	104	VSP-511	DB15M - DB15F VESDANet Cable	104	X900	Testfire Smoke/Heat/CO test kit	117
VLF-500-02	LaserFOCUS	100	VSP-515	LaserCOMPACT Termination Card (VN)	100	XLG-C/S	XL Graphics	39
VLI-880	LaserINDUSTRIAL Detector c/w Relays	105	VSP-715	LaserFOCUS VLF-500 2 Fan Module	104	ZZZ	End of Index	
VLI-885	LaserINDUSTRIAL Det, Relays, VESDANet	105	VSP-850	VESDA Inline Filter incl. Elements	104			
VLP-000ETN	LaserPLUS Det.+3 Blanks Equiv.-to-new	104	VSP-855-20	VESDA Inline Filter Elements only pkt 20	104			
VLP-001	LaserPLUS Detector and Programmer	100	VSR-0	LaserPLUS Blank Sub Unit	104			
VLP-002	LaserPLUS Detector + Display	100	VSR-0002	19" Subrack with 3 Blanks,1 LaserPLUS Dply	104			
VLP-012	LaserPLUS Det+Programmer+Display	100	VSR-0022	19" Subrack, 2 Blank, 2 VLP Displays	104			
VLP-400	LaserPLUS Detector with Fire/Ok LED	100	VSR-004A	19" Subrack, 2 Blank, 1 VLS Disp,7R, 1 Prog.	104			
VLS-204	FD7 Scanner + Display	103	VSR-1	Programmer sub-unit	104			
VLS-214	FD7 Scanner + Programmer + Display	103	VSR-2	Destector display sub-unit	104			
VLS-304	FD12 Scanner + Display	103	VSR-3	VESDANet Socket	104			
VLS-314	FD12 Scanner + Programmer + Display	103	VSR-300J	19" Subrack,1VN Skt, 2 Blank, 1 VLC Disp,7R	104			
VLS-600	FD7 LaserPLUS Scanner+Fire OK LED	103	VSR-4	LaserSCANNER Display sub-unit+7 relays	104			
VLS-700	FD12 LaserPLUS Scanner+Fire OK LED	103	VSR-5	Blank sub-unit with 7 relays	104			
VRT-100	Remote Programmer	103	VSR-6	LaserSCANNER with RTC no relay	104			
VRT-200	Remote Display Including 7 Relays	103	VSR-7	LaserSCANNER Display with RTC 7 relay	104			
VRT-300	Remote VESDANet Socket	103	VSR-8	LaserSCANNER Display with RTC 12 relays	104			
VRT-400	Remote Scan Display Incl 7 Relays	103	VSR-9	Display relay processor RTC 12 relays	104			
VRT-600	Remote Detector Display - No Relays	103	VSR-CUSTOM	Custom Sub-Rack housing incl custom built				
VRT-700	Remote Scanner Display - No Relays	103		4 VSU sub rack units	104			
VRT-800	Remote Scanner Display with 12 Relays	103	VSR-E	Blank LaserSCANNER sub-unit 7 relays	104			
VRT-J00	LaserCOMPACT Remote Disp+7 Relays	103	VSR-J	LaserCOMPACT Display sub-unit 7 relay	104			
VRT-K00	LsrCOMPACT Rem. Dsply w/o I/F Relays	103	VSR-K	LaserCOMPACT Display RTC no relays	104			
VRT-Q00	LsrINDUSTRIAL Rem. Dsply +7 Relays	103	VSR-S	System Relay Module	104			
VRT-T00	LsrINDUSTRIAL Rem. Dsply no Rlys	103,105	VSR-V	LaserFOCUS Display RTC7	104			
VSP-001	Programmer (Spare)	104	VSR-W	LaserFOCUS Display RTCO	104			
VSP-002	Detector Display (Spare)	104	VSW-002	ASPIRE for Windows design software	104			
VSP-004	Scanner Display (Spare)	104	VSW-004	VConfig Basic software	104			

Product/Category Page Reference

Product/Category Page Reference

Product Index

130 Series Addressable Detector.....	41	Probe Type Detector.....	112
130 Series Addressable Module.....	43	QE90 EWIS Panel & Acc.....	77,130
130 Series Base.....	42	Remote Annunciators.....	74
Alarm Acknowledge Module.....	63	Remote Indicator.....	61,62,74,112
AS1668 Controls.....	72	Responders.....	14,15,30,31,32,
AVI Signs.....	95	Simplex Addressable Module.....	56
Batteries.....	96	Sounder.....	24,27,87,88,90
Beam Type Smoke Detector.....	113	Speaker.....	77,91-93
Bell.....	94	Strobe.....	77,89
Cables.....	69	Tone Generator.....	49,84
CCU.....	75	VESDA Accessories.....	100
Conventional (Non-Addressable) Detectors.....	49	VESDA Detectors.....	100
Detector Accessories.....	61	VESDA Pipe & Fittings.....	106
Detector Test Equipment.....	117	VESDA Pipe Labels.....	106
Detectors.....	7,8,9,12,118	VIGILANT Panel Accessories.....	7-124
Door Holder.....	99	Warning System Ancillaries.....	87
Duct Sampling Unit.....	8,17,55	WIP Phone.....	79
Fan Control.....	72	XL Graphics.....	36
Fire Wire.....	113		
Flame Detector.....	12,17,61,107,108,109,118,121		
Functional Detector Base.....	21		
Gas Control Panel.....	6,12		
Gear Plate.....	65,67,68		
Horn Speaker.....	91,92		
Intrinsically Safe Barrier.....	113		
Intrinsically Safe Detectors.....	108,110,112,113		
IO-NET.....	32,33		
Looms.....	69-71		
MX Addressable Detector.....	48		
MX Addressable Manual Call Point.....	15,47		
MX Addressable Module.....	28		
MX1 Fire Alarm Panel.....	33		

Terms and Conditions

1. General

Unless the context otherwise requires:

Agreement means the agreement between Supplier and Customer for the supply of Goods by Supplier to Customer and shall be constituted in its entirety by these Terms and Conditions of Sale and, if any, Supplier's quotation and the Confidential Credit Application and Agreement;

Australian Consumer Law means Schedule 2 of the Competition and Consumer Act 2010;

Credit Arrangement means the credit terms available to Customer pursuant to an application by Customer for the provision of Goods on credit submitted to Supplier using Supplier's standard credit application form and accepted in writing by Supplier (referred to as the Confidential Credit Application and Agreement);

Customer means the party to whom Supplier has agreed to supply Goods pursuant to the Agreement;

Goods means the goods and/or services agreed to be supplied by Supplier and purchased by Customer pursuant to the Agreement;

GST has the meaning given by the A New Tax System (Goods and Services Tax) Act 1999 (Cth) or, if that Act does not exist means any Act imposing or relating to the imposition or administration of a goods and services tax in Australia and any regulation made under that Act;

Guarantee means the guarantee document provided by Customer or Customer's directors, shareholders or principals to Supplier to guarantee the performance of the Agreement by Customer;

Proprietary Information means any and all information and intellectual property relating to the Goods or the installation or operation of the Goods including but not limited to patents, designs, drawings, instruction booklets, specifications, circuit drawings, componentry, trade secrets, trade marks and copyright in such information and intellectual property;

Purchase Order means the written purchase order by Customer to Supplier for the supply of the Goods;

Supplier means the company named in the quotation for the Goods or, if there is no quotation, the entity named in the invoice.

Supplier Group means that group of companies comprising the Supplier and each of its related bodies corporates and affiliates (wherever located) which have the same ultimate holding company.

Wilful Misconduct means any wilful or intentional breach, act or omission done by the Supplier:

- (a) with the intent to cause Customer material harm; or
- (b) where the Supplier was aware that material harm would result from such wilful or intentional breach, act or omission.

2. Quotations and purchase orders

- (a) Subject to the clause immediately below, quotations from Supplier are valid for a period of 30 days from the date of issue or as otherwise specified in the quotation. Prices given in any quotation by Supplier are applicable to that quotation only, and will not apply in any other instances. A quotation from Supplier is not an offer to sell.
- (b) In order to purchase the Goods, Customer must place with Supplier a Purchase Order setting out an order number, Supplier's quotation number (if applicable), full description of the Goods to be purchased, the delivery date, delivery point and any other information required by Supplier. The Purchase Order may be accepted or rejected by Supplier at Supplier's sole discretion.
- (c) A contract shall be formed by and upon Supplier accepting from Customer a Purchase Order pursuant to the clause immediately above and each contract shall be governed by the Agreement.
- (d) The Agreement shall take precedence over any other representations, agreements, arrangements or understandings relating to the Goods and any matters in connection with the Goods.
- (e) Any conditions or terms of purchase submitted by Customer deviating from or inconsistent with the Agreement will not bind Supplier, notwithstanding any statement by Customer in its Purchase Order that its terms and conditions prevail over the Agreement.
- (f) Where the Goods to be supplied contain raw materials, the price and availability of which is unpredictable (for example, PVC, copper, steel), and there is a lack of availability of such raw material either to enable Supplier to supply the Goods or to supply the Goods at the price stated in the Purchase Order, Supplier may, at its sole option:
 - (i) expend additional time to make reasonable efforts to attempt to locate raw material, and if raw material cannot be located, serve notice of immediate termination of the Purchase Order under the Agreement; or
 - (ii) endeavour to reach agreement with Customer on an increase in the purchase price for the Goods, and if agreement cannot be reached, serve notice of immediate termination of the Purchase Order under the Agreement; or
 - (iii) serve notice of immediate termination of the Purchase Order under the Agreement. In no case shall Supplier have any liability to Customer as a result of termination, but Customer shall pay to Supplier the purchase price of Goods actually supplied under the Agreement.

3. Payment of purchase price

- (a) Unless otherwise agreed in writing, Supplier accepts Purchase Orders subject to the condition that Customer agrees to pay the purchase price appearing on Supplier's price list for those Goods current as at the date that Supplier accepts the Purchase Order.
- (b) If applicable, a copy of Supplier's publicly available price list for the Goods is available on request. All prices on Supplier's price list are

subject to alteration without notice.

- (c) The total purchase price, unless otherwise stated in the Purchase Order, includes GST but does not include any delivery charges, packaging, freight, assembly costs, installation costs, costs and charges of third party suppliers such as electricians, insurance or any statutory, sales, excise, or other taxes, duties or imposts, all of which may be added to the purchase price or otherwise will be paid by Customer or reimbursed by Customer to Supplier, as Supplier may elect.
- (d) Payment of the purchase price must be made in full within 30 days after the date of the invoice or otherwise in accordance with Customer's Credit Arrangement.
- (e) Customer must not set off any money owing or alleged to be owing by Supplier against money due by Customer to Supplier.
- (f) Customer acknowledges that Supplier is a member of the Supplier Group. Customer agrees that Supplier and/or any other Supplier Group company is entitled to exercise a right of set off to the extent Customer is indebted to Supplier or to any Supplier Group company against any monies due by Supplier to Customer or any Supplier Group company on this or any other account.
- (g) If Customer does not pay money by the due date for payment, without prejudice to any other rights which it may have against Customer, Supplier may require Customer to pay on demand interest at the Westpac Indicator Lending Rate effective from time to time plus 4% per annum calculated from the due date on daily balances of amounts unpaid.

4. Cancellation of orders

Customer may not alter or cancel a Purchase Order without Supplier's prior written consent. If Supplier agrees to alter or cancel the Purchase Order, Customer will indemnify Supplier against any loss, damage and expense incurred by Supplier in relation to the alteration or cancellation of that Purchase Order, including the cost of return freight, return shipping to factory of origin, items purchased from third parties for inclusion in the Goods and all labour and engineering costs incurred by Supplier in the execution or part execution of the Goods and including compensation payable to any of Supplier's suppliers and loss of profit except to the extent that such loss, damage or expense is caused by or contributed to by Supplier's Wilful Misconduct or fraud.

5. Return of Goods and credits

- (a) Customer is deemed to have accepted the Goods unless it makes a claim in accordance with the clause immediately below.
- (b) Customer may reject any Goods that are wrongly supplied or oversupplied by notifying Supplier of the claim and providing full particulars of the claim in writing within 5 days of receipt of those Goods. Supplier may dispute any such claim.
- (c) Goods referred to in the clause immediately above may be returned to Supplier for credit if all of the following is complied with:
 - (i) the Goods are returned to Supplier's premises by prior arrangement and with Supplier's written approval within 7 days of delivery, at no cost to Supplier, unless delivered as the result of an administrative error by Supplier, in which case Supplier will bear the cost of return;
 - (ii) the Goods are accompanied by a dispatch note stating Supplier's original invoice number and reason for return; and (iii) the Goods are returned in an unsoiled, undamaged and resaleable condition in their original packing.
- (d) Customer must not return any Goods to Supplier unless it has complied with the two clauses immediately above and has done all things necessary to permit Supplier to examine the Goods to Supplier's satisfaction within that period.

6. Delivery, Storage and Use

- (a) All quoted delivery or consignment dates are estimates only. Supplier is not obliged to meet such dates and will not be liable to Customer by reason of delays caused by any reason whatsoever.
- (b) Supplier is deemed to have delivered the Goods when the Goods are made available to Customer for physical collection by or on behalf of Customer at Customer's nominated delivery point (Delivery). Any unloading or loading shall be Customer's responsibility, unless Supplier otherwise agrees in writing.
- (c) Supplier may deliver the Goods by instalments (where, in Supplier's opinion, this is reasonable) and issue interim invoices to Customer.
- (d) Without limiting any other provision of the Agreement, failure by Customer to pay any instalment, or any other amount when due, will entitle Supplier to withhold or delay delivery of any remaining Goods ordered.
- (e) If Customer is unable to collect the Goods at Customer's nominated delivery point on the delivery day, Supplier may (at its option and without limiting its other rights and remedies) arrange suitable storage of the Goods, whether at its premises or elsewhere, and Customer must pay or reimburse all costs and expenses of storage, insurance, demurrage, handling and other charges associated with such storage. Notwithstanding Customer's inability to collect the Goods, Delivery is deemed to have occurred.
- (f) The Customer must not install, store or in any way incorporate the Goods in any aircraft or in any vessel intended to fly or move in or through the atmosphere or space.
- (g) The Customer acknowledges that it has the sole responsibility to confirm the suitability of the Goods for their intended purpose and that Supplier makes no representation or warranty in this regard.

7. Title and risk

- (a) Title to the Goods shall remain with Supplier until all monies owing by Customer to Supplier for the Goods have been paid in full.
- (b) Until such time as Customer has paid Supplier in full for the Goods, Customer shall:
 - (i) store the Goods separately and mark them so that they are clearly and easily identifiable as Supplier's property and, if Supplier requests, inform Supplier of the location of the Goods;
 - (ii) hold the Goods as bailee for Supplier, subject to Customer's right to deal with the Goods in the ordinary course of Customer's business (Bailment);
 - (iii) indemnify Supplier against any claim arising out of the possession, use or disposal of the Goods by Customer or repossession or attempted repossession by Supplier.
- (c) If:
 - (i) a payment is not made in accordance with the Agreement;
 - (ii) Customer commits any other breach of the Agreement;
 - (iii) Customer becomes bankrupt, has an administrator, a receiver or a receiver and manager appointed, goes into liquidation (whether voluntarily or otherwise), or is wound up, dissolved or declared insolvent, then Supplier may at any time, without notice to Customer and without prejudice to any other rights that it may have against Customer:
 - (i) terminate the Agreement and the Bailment;
 - (ii) suspend some or all its obligations to Customer under the Agreement; and/or
 - (iii) enter upon any premises owned or occupied by Customer where Supplier reasonably believes the Goods may be stored and repossess the Goods (including uninstalling the Goods) without being liable for any damages caused.
- (d) If Customer sells the Goods before payment in full to Supplier, or uses the Goods in a manufacturing or construction process of its own or some third party, Customer holds the proceeds on trust for Supplier in respect of those Goods, and must keep such proceeds in a separate account until the liability to Supplier is discharged and must immediately pay that amount to Supplier.
- (e) The risk in the Goods passes to Customer at the time of Delivery.
- (f) Supplier reserves the right to register a security interest for the purposes of the Personal Property Securities Act 2009, as amended. The Customer agrees to provide Supplier with all such information that Supplier requires in order to register a security interest at anytime. The Customer will immediately advise Supplier of any changes which may affect Supplier's security interest.

8. Insurance

Customer must keep the Goods insured against all risks for Goods of that kind from the time the risk in the Goods passes to Customer until the time that title to the Goods passes to Customer. Customer holds the proceeds of that insurance on trust for Supplier up to the amount it owes Supplier in respect of those Goods, and must keep such proceeds in a separate account until the liability to Supplier is discharged and must immediately pay that amount to Supplier.

9. Warranty and Limitation of liability for Goods

- (a) Other than is provided for in this clause 9, Supplier makes no warranties or representations to Customer. The warranty in this clause 9 is in addition to any other rights or remedies which may be available to Customer at Law.
- (b) Supplier warrants the Goods to be free from defects in workmanship and materials under normal use and service for a period of 1 calendar year from the Delivery (Warranty Period). This warranty does not cover costs of claiming under this warranty or of recovery of the Goods from the site or damage, fault, failure or malfunction due to external causes including accident, abuse, misuse, mechanical or electrical overload, abrasion, corrosion, incorrect installation, failure to comply with Supplier's or the original manufacturer's instructions (including any installation, operating or maintenance instructions or manuals), failure to perform required preventative maintenance or normal wear and tear.
- (c) During the Warranty Period, to the extent permitted by law, Customer's sole remedy with respect to breach of warranties set out in the clause immediately above will be to repair or replace (as Supplier may elect) any such defective Goods at Supplier's expense. The replacement or repaired Goods shall be covered by the unexpired portion of the Warranty Period in respect of the original Goods or for a period of 90 days, whichever is the greater.
- (d) For equipment forming part of the Goods, which equipment is not manufactured by Supplier, the original manufacturer's warranty will apply. Supplier's liability for such equipment shall not exceed the liability of the manufacturer.
- (e) In respect of Goods that are not ordinarily acquired for personal, domestic or household use or consumption, the liability of Supplier for a breach of any condition or guarantee applied by law is limited at Supplier's option to the repair of the Goods, the supply of replacement Goods or payment of the cost of having the Goods supplied again.
- (f) Supplier's liability under the Agreement will be reduced by the amount of any contributory loss or damage to the extent caused by Customer's act or omission.
- (g) To the extent that any goods or services supplied by Supplier are supplies to a 'consumer' as defined in the Australian Consumer Law, Supplier will comply with any applicable consumer guarantees and the following statement will apply: "Our goods come with guarantees that cannot be excluded under the Australian Consumer Law. You are entitled

- to a replacement or refund for a major failure and for compensation for any other reasonably foreseeable loss or damage. You are also entitled to have the goods repaired or replaced if the goods fail to be of acceptable quality and the failure does not amount to a major failure."
- (h) Any warranty claim must detail the basis of the alleged warranty breach in writing and be delivered to Supplier by Post at Johnson Controls, Level 3, 95 Coventry Street, Southbank, VIC 3006 attention to Customer Service.
- (i) Customer acknowledges and agrees that, to the extent permitted by law, Supplier has no liability in contract, tort (including negligence or breach of statutory duty), by statute or otherwise for loss or damage (whether direct or indirect) of profits, opportunity, revenue, goodwill, bargain, production, contracts, business or anticipated savings, corruption or destruction of data or for any indirect, special or consequential loss or damage whatsoever except to the extent that such losses are caused by or contributed to by Supplier's Wilful Misconduct or fraud.
- (j) Subject to clause 9(g), Supplier's total liability under any contract and the Agreement shall not exceed the total dollar amount of the Goods purchased by Customer under each contract.

10. Proprietary Information

- (a) Customer acknowledges that all Proprietary Information and all right, title and interest therein are the sole property of or licensed by Supplier and Customer shall gain no right, title or interest in the Proprietary Information whatsoever. Customer specifically acknowledges Supplier's exclusive rights to ownership of any modification, translation or adaptation of the Proprietary Information and any other improvement or development based thereon, whether developed, supplied, installed or paid for by or on behalf of Customer or any buyer of Customer or otherwise.
- (b) Customer must not and must not permit any person reasonably within its control nor procure any person to modify, copy, clone or reverse engineer the Goods, or copy, modify or decompile any of Supplier's documentation relating to the Goods.

11. Export/re-export/resale

- (a) The Goods supplied are intended for use only in Australia, unless Supplier otherwise agrees. If Customer exports or re-exports the Goods, it is Customer's responsibility to ensure that the Goods and the use to which they are put comply with the laws of the destination.
- (b) Customer acknowledges that the Goods purchased by Customer may not be sold, leased or otherwise transferred to or utilised by a terrorist organisation, a party listed on any US denied persons or entities list or by an end-user engaged in activities related to weapons of mass destruction, including but not limited to activities related to design, development, production or use of nuclear materials, nuclear facilities or nuclear weapons, missiles or support of missile projects, or chemical or biological weapons.
- (c) If Customer resells the Goods, it shall not, in connection with their resale, pay or offer to pay, money or any thing of value to any government official, entity or organisation, any political party, any candidate for public office, or their employees or relatives, or any other person or entity for the purpose of influencing purchasing decisions or for any other improper purpose.

12. Miscellaneous

- (a) The fact that Supplier fails to do, or delays in doing, something it is entitled to do under the Agreement, does not amount to a waiver of its right to do it. Supplier must agree in writing to any waiver.
- (b) If a clause or part of a clause can be read in a way that makes it illegal, unenforceable or invalid, but can also be read in a way that makes it legal, enforceable and valid, it must be read in the latter way. If any clause or part of a clause is illegal, unenforceable or invalid, that clause or part is to be treated as removed from the Agreement, but the rest of the Agreement is not affected.
- (c) Supplier shall not be liable for any failure to fulfil or any delay in fulfilling any obligation arising under the Agreement if the failure or delay has been caused directly or indirectly by any act of God, war or other civil commotion, strikes, lockouts, stoppages and restraints of labour, breakdown of machinery, inability to obtain raw materials or fuel, fire or explosion, any government action or any other cause beyond Supplier's reasonable control and not as a consequence of Supplier's negligence.
- (d) Any notice to be given to a party under the Agreement must be in writing and must be sent by post, facsimile or email to the address of that party shown in the quotation, Purchase Order or order acknowledgment. Notice is deemed to have been given at the time it would have been received in the normal course of post if sent by post, or if otherwise given at the time it was actually received.
- (e) The Agreement is governed by and must be interpreted in accordance with the laws of the State or Territory where Supplier supplies the Goods and the Goods are delivered. Where there are multiple places of supply and/or delivery, Supplier may elect the State or Territory in Australia that shall have jurisdiction over the Agreement. Customer unconditionally submits to the non-exclusive jurisdiction of the courts of the State or Territory determined in accordance with this clause.
- (f) Where there is more than one Customer then the liability of each shall be joint and several.
- (g) The rights and remedies provided in the Agreement will not affect any other rights or remedies available to Supplier.
- (h) Customer shall not assign this Agreement without Supplier's prior written consent.
- (i) If the Customer is a trustee, then the Customer is bound by the Agreement both personally and in its capacity as a trustee.

Global Strength. Local Expertise. At your service.

Johnson Controls - Customer Service - Fire Detection - Australia

Telephone: 1300 725 688 | Facsimile: 1300 720 733 | Email: fdp.customerservice.anz@jci.com

The right is reserved to modify or withdraw any product or service without notice

Australia Fire Product Catalogue Issue 6

© 2020 Johnson Controls. All rights reserved.

www.vigilant-fire.com.au

